

Operating Instructions

DULCOMETER® D1C

Part 2: Adjustment and Operation,
Measured Variable pH

D1C-001 D

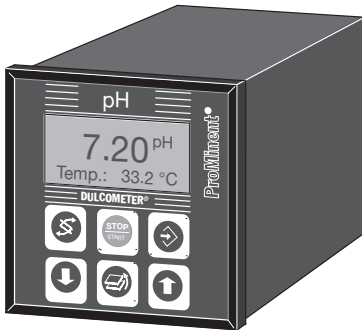

Type D



Type W

D1C A

Please enter the identity code of your device here!

**Please completely read through operating instructions! · Do not discard!
The warranty shall be invalidated by damage caused by operating errors!**

1 Device Identification / Identity Code

D1C A		DULCOMETER® Controller Series D1C / Version A	
		Type of mounting	
D		Control panel installation 96 x 96 mm	
W		Wall mounting	
		Operating voltage	
0		230 V 50/60 Hz	
1		115 V 50/60 Hz	
2		200 V 50/60 Hz (only with control panel installation)	
3		100 V 50/60 Hz (only with control panel installation)	
4		24 V AC/DC	
		Measured variable	
P		pH (0 - 14)	
		Connection of measured variable	
1		Terminal, standard signal 0/4-20 mA	
2		SN6 connector	
5		Terminal mV	
		Correction variable	
0		None	
2		Temperature via terminal	
3		Temperature via standard signal	
4		Manual temperature entry	
		Feed forward control	
0		None	
1		As standard signal 0/4-20 mA	
2		As frequency 0-500 Hz	
3		As frequency 0-10 Hz	
		Control input	
0		None	
1		Pause	
		Signal output	
0		None	
1		standard signal 0/4-20 mA measured value	
2		standard signal 0/4-20 mA control variable	
3		standard signal 0/4-20 mA correction variable	
4		2 standard signal 0/4-20 mA output, free programmable	
		Power control	
G		Alarm and 2 limit value/timer relays	
M		Alarm and 2 solenoid valve relays	
R		Alarm relay and servomotor with feedback	
		Pump control	
0		None	
2		Two pumps	
		Control characteristic	
0		None	
1		Proportional control	
2		PID control	
		Log output	
0		None	
		Language	
D		German	
E		English	
F		French	
I		Italian	
N		Dutch	
S		Spanish	
P		Polish	
A		Swedish	
B		Portuguese	
U		Hungarian	
G		Czech	

D1C A

Please enter the identity code of your device here!

2 Contents / General User Information

	Page
1 Device Identification / Identity Code	2
2 General User Information	3
3 Device Overview / Controls	4
4 Display Symbols	5
5 Operation	6
6 Reduced Operating Menu	7
General Layout	7
Description	8
7 Complete Operating Menu	15
Overview	15
Description	16
8 Faults / Notes / Troubleshooting	33

General User Information

These operating instructions describe the technical data and function of the series DULCOMETER® D1C controller, provide detailed safety information and are divided into clear steps.



IMPORTANT



- *Please observe the parts of these operating instructions applicable to your particular version! This is indicated in the Section “Device Identification / Identity Code”.*
- *Correct measuring and dosing is only possible in the case of impeccable operation of the probe. The probe has to be calibrated / checked regularly!*

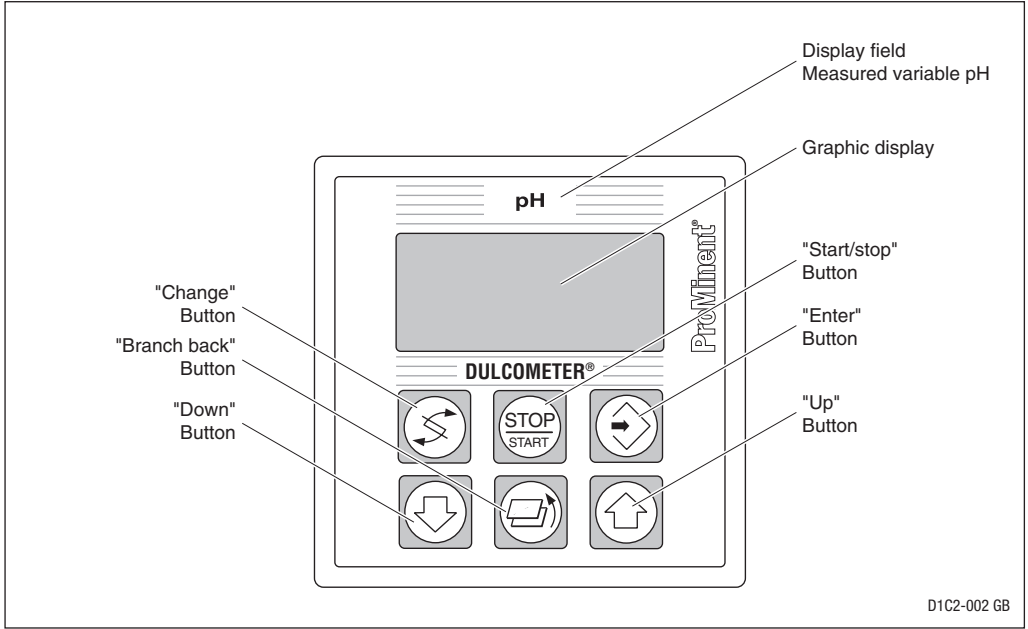

NOTE

A form “Documentation of controller settings Type D1C” is available under www.prominent.com/documentation_D1C for the purpose of documenting the controller settings.

3 Device Overview / Controls

























	<p>CHANGE button</p> <p>To change over within a menu level and to change from one variable to another within a menu point.</p>
	<p>START/STOP button</p> <p>Start/stop of control and metering function.</p>
	<p>ENTER button</p> <p>To accept, confirm or save a displayed value or status. For alarm acknowledgement.</p>

	<p>UP button</p> <p>To increase a displayed numerical value and to change variables (flashing display)</p>
	<p>BRANCH BACK button</p> <p>Back to permanent display or to start of relevant setting menu.</p>
	<p>DOWN button</p> <p>To decrease a displayed numerical value and to change variables (flashing display).</p>

4 Display Symbols

The display of the DULCOMETER® D1C controller uses the following symbols:

Description	Comment	Symbol
Limit value transgression Relay 1, upper	Symbol left	
Relay 1, lower	Symbol left	
Relay 2, upper	Symbol right	
Relay 2, lower	Symbol right	
Metering pump 1 (alkali) Control off	Symbol left	
Control on	Symbol left	
Metering pump 2 (acid) Control off	Symbol right	
Control on	Symbol right	
Solenoid valve 1 (alkali) Control off	Symbol left	
Control on	Symbol left	
Solenoid valve 2 (acid) Control off	Symbol right	
Control on	Symbol right	
Servomotor Control, open relay		 
Control, close relay		 
Without control		 
Position feedback	The bar increases from left to right during opening.	
Stop button pressed		
Manual metering		
Fault		

5 Operation

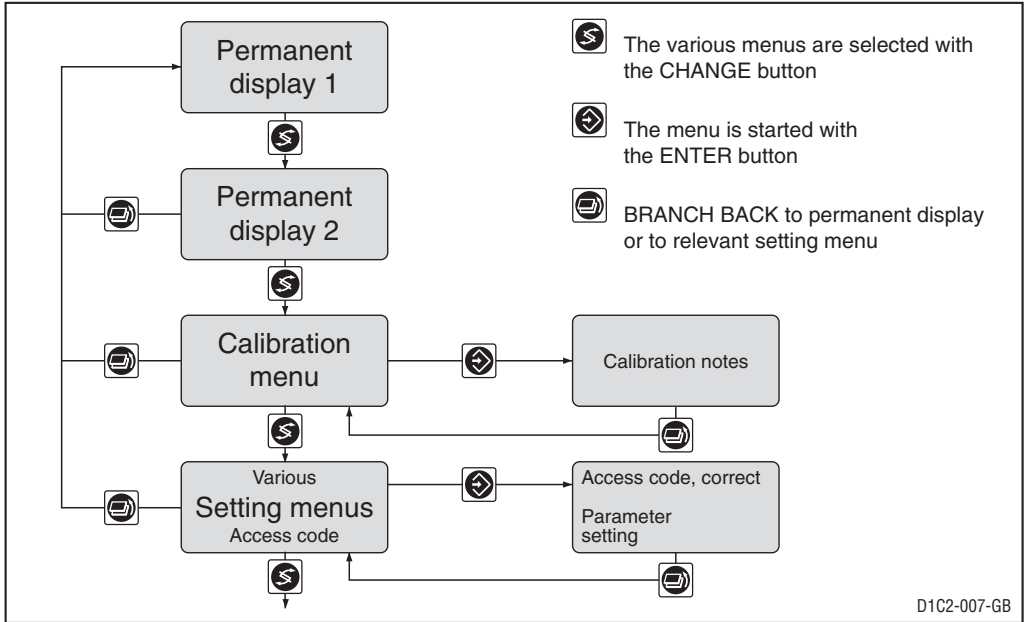

NOTE

Access to the setting menus can be barred with the access code!

The number and scope of setting menus is dependent on the device version!

If the access code is selected correctly in a setting menu, then the following setting menus are also accessible!

If within a period of 10 minutes no button is pushed, the unit automatically reverts from the calibrating menu or a setting menu to the permanent display 1.

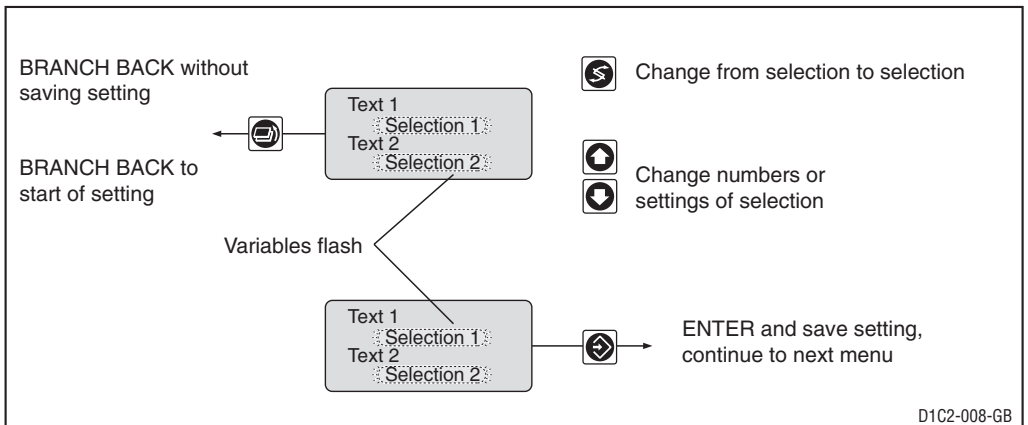

6 Reduced Operating Menu / General Layout

Operating Menu

The DULCOMETER® D1C controller permits settings to be made in two different menus. All values are preset and can be changed in the **complete operating menu**.

The controller is delivered with a **reduced operating menu** so that the DULCOMETER® D1C controller can be used effectively in many applications from the very on-site. If adaptations prove to be necessary, all relevant parameters can then be accessed by switching over to the complete operating menu (see "General settings information").

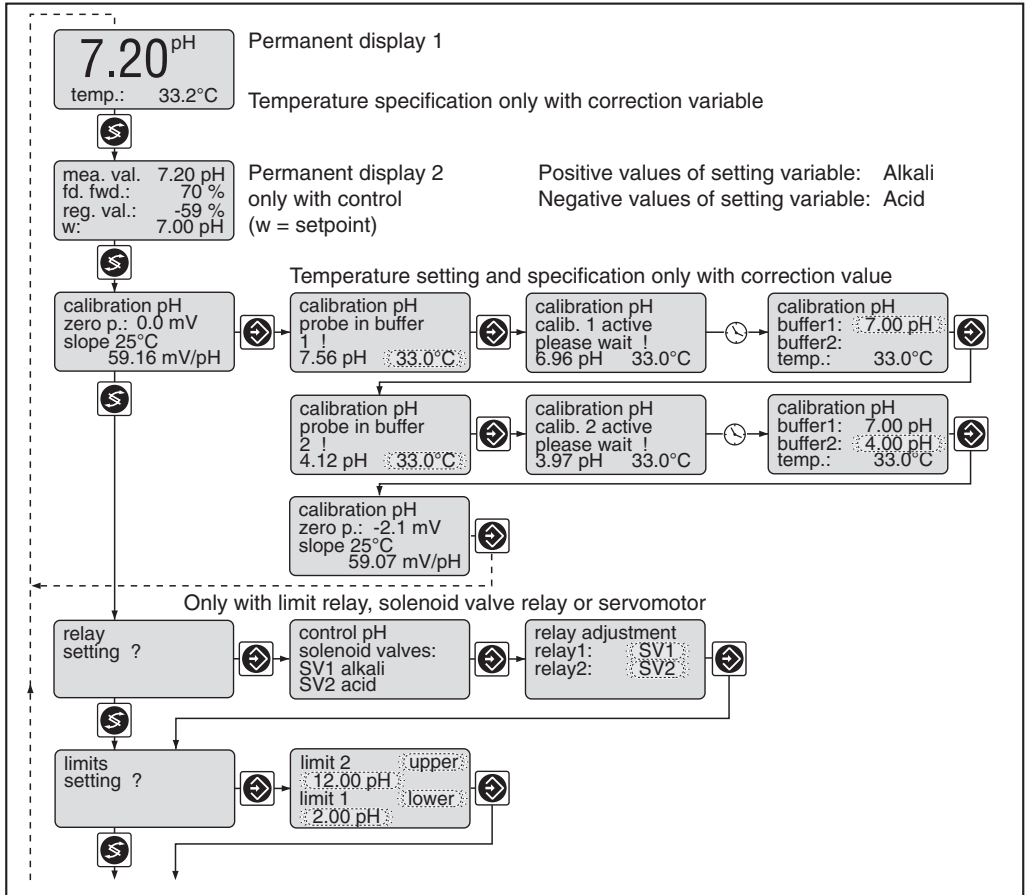

Reduced Operating Menu / Description

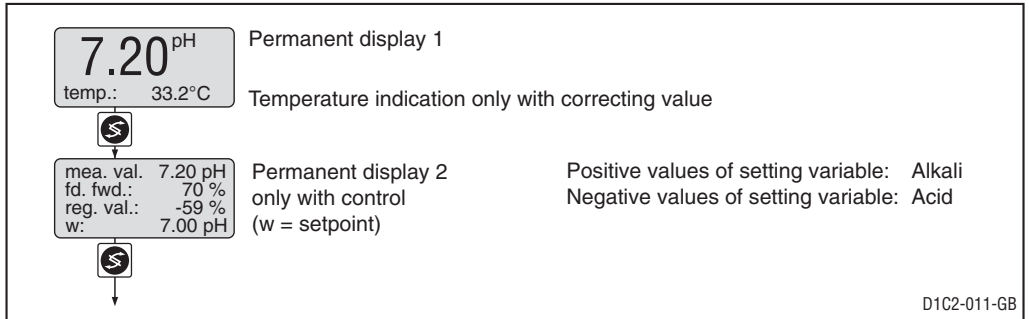
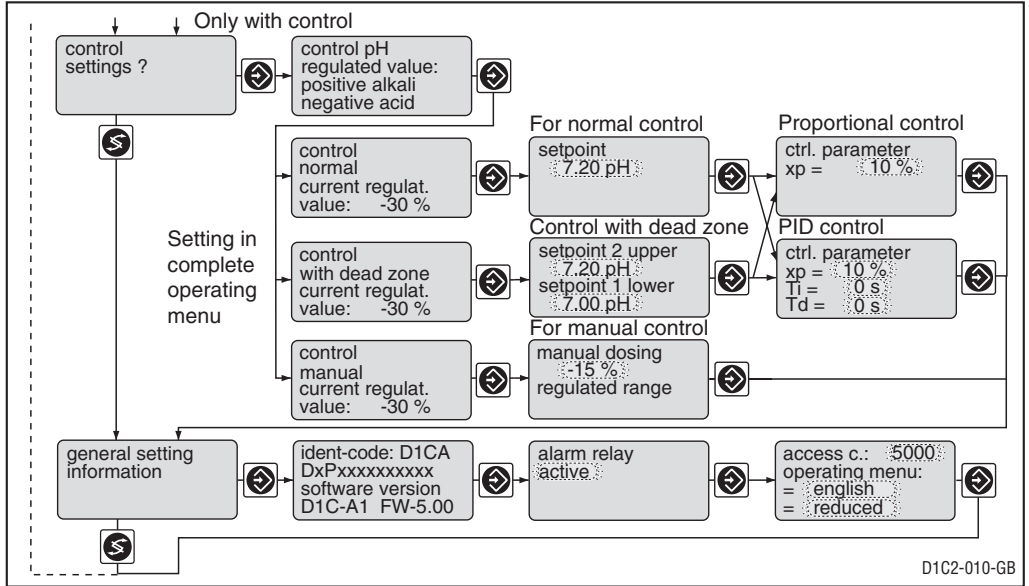

Error Messages

Error messages and information are indicated on the bottom line in the permanent display 1. Errors to be acknowledged (acknowledgement switches off the alarm relay) are indicated by the "E". Errors/notes which still apply after acknowledgement are indicated alternately. During correction variable processing (temperature for correction of pH-value), the value is indicated in the same line as the error/note. Faults which are rectified of their own accord due to changed operating situations are removed from the permanent display without the need for acknowledgement.

Reduced Operating Menu / Description

Calibrating the pH probe

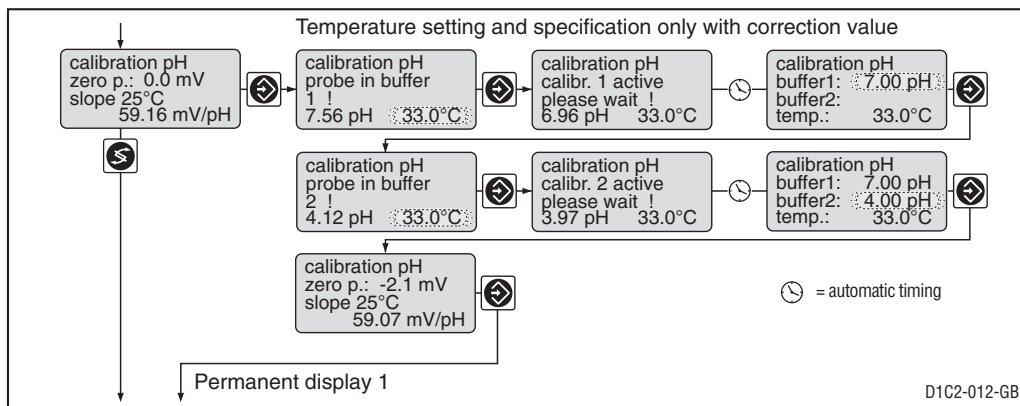

	Initial value	Possible values			Remarks
		Increment	Lower value	Upper value	
Calibration temperature	Measured temperature value	0.1 °C	0 °C	100 °C	
Buffer values	Rounded-off whole number measured value	0.01 pH	-2 pH	16 pH	Error messages when both buffers too close (<2 pH-values)

Error message	Condition	Effect
Buffer distance too small	$\Delta\text{Buffer} < 2 \text{ pH}$	During calibration procedure: Recalibrate buffer 2!
pH zero point low	$< -60 \text{ mV}$	Return to permanent display: Basic metering load Warning, old zero point and slope retained
pH zero point high	$> +60 \text{ mV}$	
pH slope low	$< 40 \text{ mV/pH}$	
pH slop high	$> 65 \text{ mV/pH}$	
Measured value pH unsteady		
Measured value °C unsteady		

During calibration the DULCOMETER® D1C sets the adjustment outputs to "0". Exception: if a basic load or manual variable has been set, these are maintained during calibration. The output signals mA (measured value or adjustment value) are frozen.

The recommended buffer value is the measured value rounded-off to the nearest whole number or the last recorded buffer value. Buffer values are adjustable (using arrow keys!).

With successful calibration, all fault finding relating to the measured values is re-started. The DULCOMETER® D1C stores the data established for zero point and slope.

Reduced Operating Menu / Description

Limits

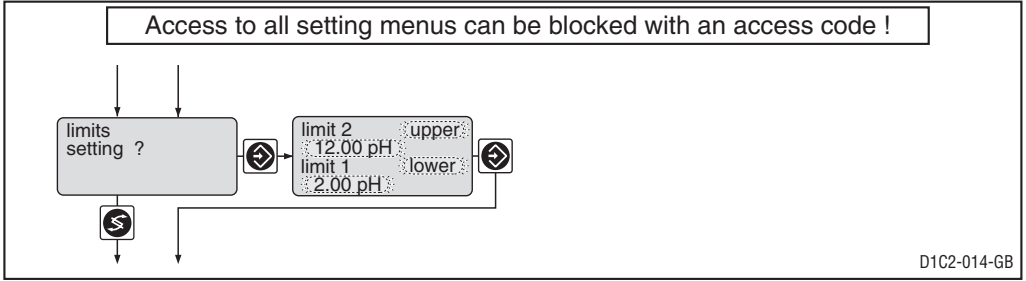

	Initial value	Possible values			Remarks
		Increment	Lower value	Upper value	
Type of limit transgression	Limit 1: lower Limit 2: upper	lower off*			Limit transgression for exceeding or dropping below limit *only with limit value relay
Limit value	Limit 1: pH 2 Limit 2: pH 12	pH 0.01 pH 0.01	pH -2 pH -2	pH 16 pH 16	

“Limit value 1, lower” means that the value has dropped below the lower limit.

“Limit value 2, upper” means that the value has exceeded the upper limit.

The DULCOMETER® D1C has the capacity to define a “hysteresis limit value” (see only complete operating menu).

The “hysteresis” works towards eliminating the limit value transgression, i.e. if the “limit value 1 upper” of pH 7.5 has exceeded a pre-set hysteresis limit value of pH 0.20, the criterion for a limit value shortfall of pH 7.3 is not applicable (see diagram below).

The characteristics of an hysteresis for a “limit value, lower” work in a similar way (here, the hysteresis value is added to the limit value). In this way, there is no need for an external self-locking relay. The control characteristics are not affected.

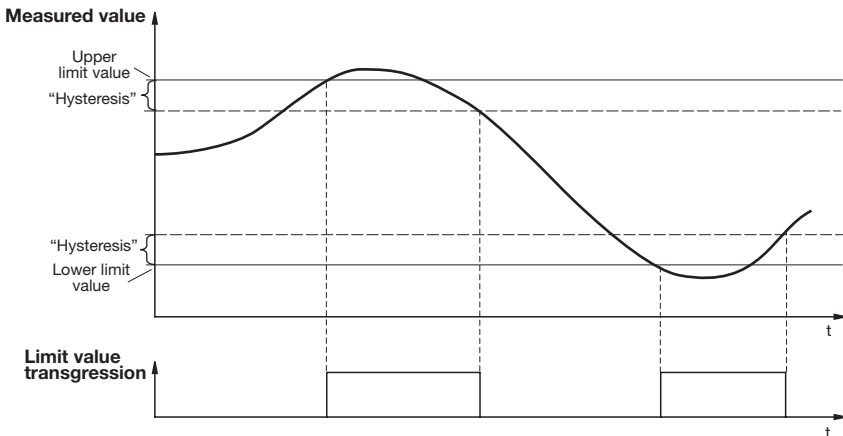

Reduced Operating Menu / Description

If limit value relays are present and are defined as such (see “relay setting?”), in the event of a limit value transgression they also function as alarm relays and the direction of the limit value transgression will be displayed by the symbol \uparrow or \downarrow .

For the limit value relays different make delays “ Δt on” and different break delays “ Δt off” can be set for limit value 1 and limit value 2. These prevent the limit value relays switching back and forth, if the limit value is only momentarily exceeded (damping function).

If no limit value relays are present, limit values can still be defined (as described above). The DULCOMETER® D1C can then display all the reactions to limit value transgression as described above.

Control

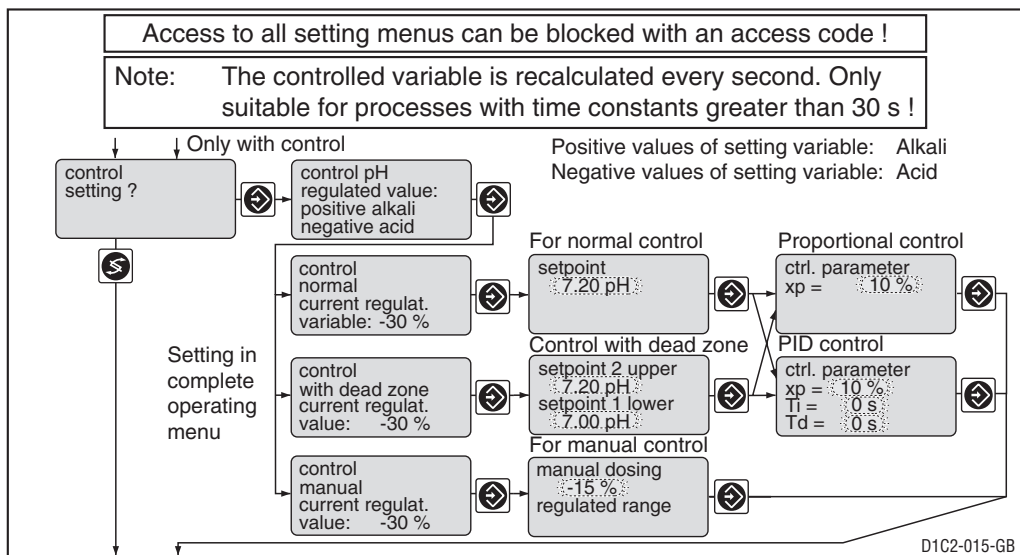

	Initial value	Possible values			Remarks
		Increment	Lower value	Upper value	
Setpoint	pH 7	pH 0.01	pH 0	pH 14	2 setpoints necessary for control with dead zone. Setpoint 1 > setpoint 2
Control parameter xp	10 %	1 %	1 %	500 %	xp referred to pH 14
Control parameter Ti	off	1 s	1 s	9999 s	Function off = 0 s
Control parameter Td	off	1 s	1 s	2500 s	Function off = 0 s
Manual metering	0 %	1 %	-100 %	+100 %	

The DULCOMETER® D1C controller can be set up as a P-, PI- or PID-controller. This depends on the system design (see Identity Code) and the control parameter setting.

The control variables are calculated once per second.

These controllers cannot be installed in control circuits, which require a fast cut-out response to control discrepancies (less than approx. 30 seconds).

It is possible to take into account cycle times by activating solenoid valves (pulse-length), and running times by activating stroke adjustment motors (3-point).

Reduced Operating Menu / Description

The control function (control variable output) can be disabled via the pause control input.
The calculation of the control variable re-commences at the end of the pause and after the expiry of the time delay period t_d .

Abbreviations for control variables:

- x: Control variable, actual value (e.g. pH-value)
- K_{PR} : Proportional coefficient
- x_p : $100 \% / K_{PR}$ (inverse proportional coefficient)
- X_{max} : Maximum measuring range of the controller (e.g. pH 14)
- y: Control output (e.g. stroke frequency to the metering pump)
- Y_h : Adjusting range (e.g. 180 strokes/min.)
- y_p : output of P-controller [e.g. %]
- w: Set point (e.g. pH 7.2)
- e: Control difference, $e = w - x$
- x_w : Control deviation, $x_w = x - w$
- T_i : Integration time of I-controller [s]
- T_d : Differential time of D-controller [s]

Control equations:

$$x_p = \frac{100 \%}{K_{PR}} \quad x_p = 100 \% * \frac{e}{Y_h}$$

This formula helps you to find out the x_p at which control difference the control output is 100 %.

Control equation of P-controller:

$$y_p = 100 \% * \frac{Y_h * (w - x)}{X_{max} * x_p}$$

Example for Y_p :

$x_p = 10 \%$, control deviation 1,4 pH
(10 % of max. measuring range)

$$y_p = 100 \% * \frac{180 \text{ strokes/min} * (\text{pH } 7 - \text{pH } 5.6)}{10 \% * \text{pH } 14}$$

= 180 strokes/min.

Control equations of PID-controller:

$$y = \underbrace{y_p}_{\text{P-control}} + \underbrace{\frac{1}{T_i} \int y_p dt}_{\text{I-control}} + \underbrace{T_d \frac{dy_p}{dt}}_{\text{D-control}}$$

Reduced Operating Menu / Description

Standard

A measured value is compared with a setpoint. In the case of a standard difference (difference between setpoint minus actual value) a control variable is determined which counteracts the standard difference.

Types of controller are as follows:

P-controller: found in applications in integrated control systems (e.g. batch neutralisation).

PI-controller : can be used in non-integrated control systems (e.g. continuous neutralisation)

PID-controller : found in applications, in which peaks occur and which must be switched off.

With dead zone

With a dead zone control (neutral zone control) two setpoints must be given. If the measured value falls within the dead zone, no control variable is output.

Setpoint 2 must be greater than setpoint 1!

Manual



IMPORTANT

The controller does not automatically exit this mode of operation.

The manual operating mode may be used for commissioning and test purposes only.

No control.

A control variable is manually specified:

Control variable: 0...+100% (control output actively rises)

Control variable: -100...0% (control output actively falls)

This function acts as a check for servo components.

Additional basic load

A basic load is added to the current control variable.

With the additional basic load, for example, values can be kept constant.

$$Y_{\text{tot}} = Y_p + 15 \% \quad (\text{additional basic load} = 15 \%)$$

Example 1:

$$Y_{\text{tot}} = 85 \% + 15 \%$$

$$\underline{Y_{\text{tot}} = 100 \%}$$

Example 2:

$$Y_{\text{tot}} = -75 \% + 15 \%$$

$$\underline{Y_{\text{tot}} = -60 \%}$$

Reduced Operating Menu / Description

General Settings

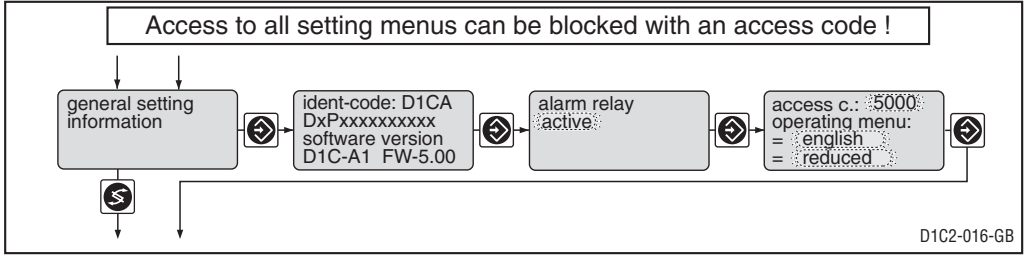

	Initial value	Possible values		Lower value	Upper value	Remarks
		Increment				
Alarm relay	active	active not active				
Access code	5000	1	1	9999		
Language	as per identity code	as per identity code				
Operating menu	reduced	reduced complete				

Access Code

Access to the setting menu can be prevented by setting up an access code. The DULCOMETER® D1C controller is supplied with the access code 5000 which permits free access to the setting menu. The calibration menu remains freely accessible even when access to the setting menu is blocked by the code.

7 Complete Operating Menu / Overview

All parameters of the controller can be set in the complete operating menu (access see previous page). The following overview shows the settings which can be selected:

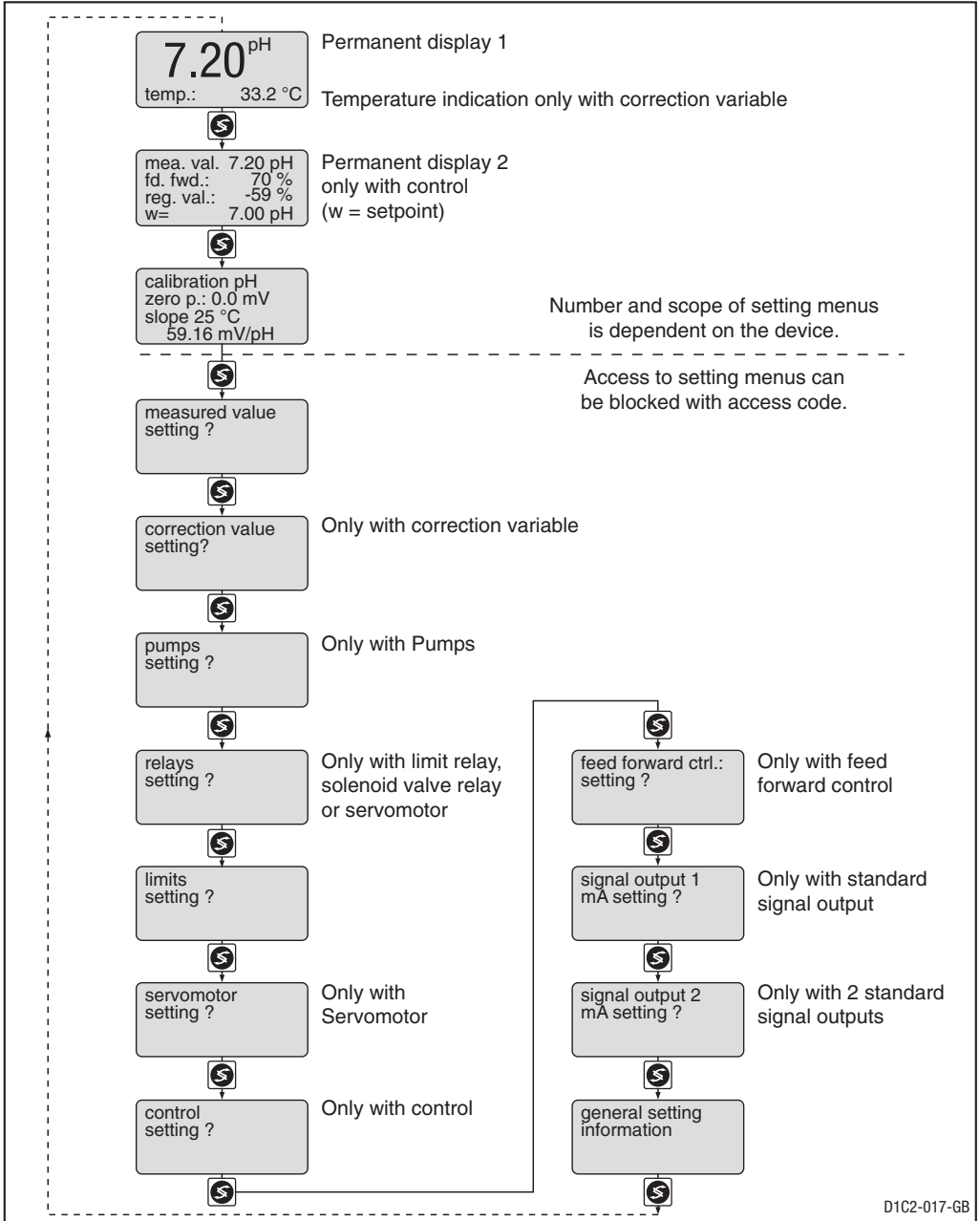

Complete Operating Menu / Description

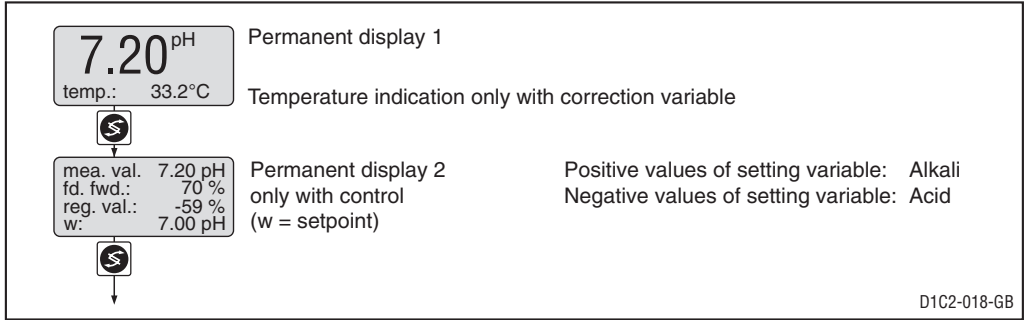

Error Messages

Error messages and information are indicated on the bottom line in the permanent display 1. Errors to be acknowledged (acknowledgement switches off the alarm relay) are indicated by the "E". Errors/notes which still apply after acknowledgement are indicated alternately. During correction variable processing (temperature for correction of pH-value), the value is indicated in the same line as the error/note. Faults which are rectified of their own accord due to changed operating situations are removed from the permanent display without the need for acknowledgement.

Calibrating the pH probe

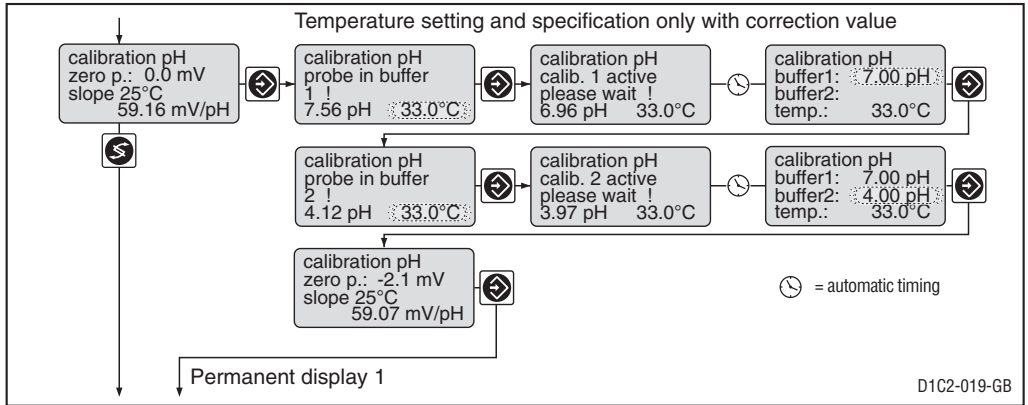

	Initial value	Possible values			Remarks
		Increment	Lower value	Upper value	
Calibration temperature	Measured temperature value	0.1 °C	0 °C	100 °C	
Buffer values	Rounded-off whole number measured value	0.01 pH	-2 pH	16 pH	Error messages when both buffers too close (<2 pH-values)

Complete Operating Menu / Description

Error message	Condition	Effect
Buffer distance too small	$\Delta\text{Buffer} < 2 \text{ pH}$	During calibration procedure: Recalibrate buffer 2!
pH zero point low	$< -60 \text{ mV}$	Return to permanent display: Basic metering load
pH zero point high	$> +60 \text{ mV}$	"
pH slope low	$< 40 \text{ mV/pH}$	"
pH slop high	$> 65 \text{ mV/pH}$	"
Measured value pH unsteady		"
Measured value °C unsteady		"

During calibration the D1C sets the adjustment outputs to "0". Exception: if a basic load or manual variable has been set, these are maintained during calibration. The output signals mA (measured value or adjustment value) are frozen.

The recommended buffer value is the measured value rounded-off to the nearest whole number or the last recorded buffer value. Buffer values are adjustable (using arrow keys!).

With successful calibration, all fault finding relating to the measured values is re-started. The DULCOMETER® D1C stores the data established for zero point and slope.

Measured Value

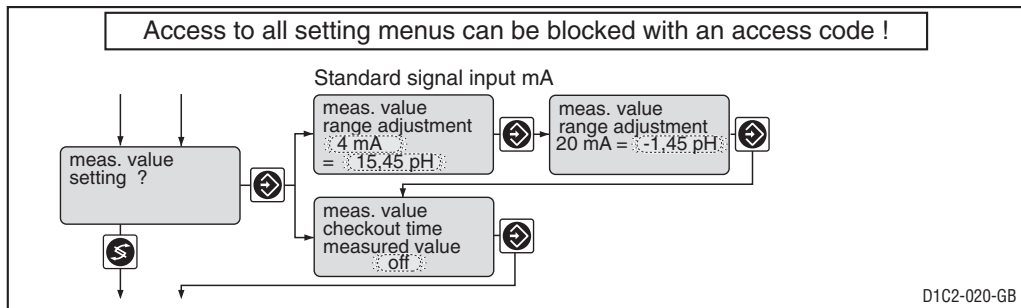

IMPORTANT

When changing the range adjustment, the adjustments in all menus have to be checked!

	Initial value	Possible values			Remarks
		Increment	Lower value	Upper value	
Standard signal input lower signal limit	4 mA	0 mA 4 mA			
Corresponding pH value	15,45 pH ... -1,45 pH	0,01 pH	19 pH	-5 pH	
Checkout time	off	1 s	1 s	9999 s	Constant measurement signal results in message and alarm. Function off = 0 s

Complete Operating Menu / Description

In place of a DULCOTEST® transducer 4-20 mA pH V1, an on site measuring transducer DULCOMETER® DMTa, measured variables pH or an external device can also be connected to a D1CaxxP1xx...
 You should take care to ensure that you differentiate between the reference ranges:

DULCOTEST® transducer pH V1:	4 mA \triangle pH 15,45	20 mA \triangle pH -1,45
DULCOMETER® DMTa:	4 mA \triangle pH 2	20 mA \triangle pH 12
External equipment:	4 mA \triangle pH 2	20 mA \triangle pH 12

Control time measured value

IMPORTANT
 **This function may not be activated in those applications where it can be assumed that the measured value does not change.**

This function checks whether the measured value from the probe (on the measured value input) changes within the “Control time measured value”. It is assumed that the probe is sound.
 If the measured value does not change during this control time, the DULCOMETER® D1C sets the control variables to “0” and the alarm relay opens. A message appears in the LCD-display, e.g. “pH probe check”.

Correction Variable

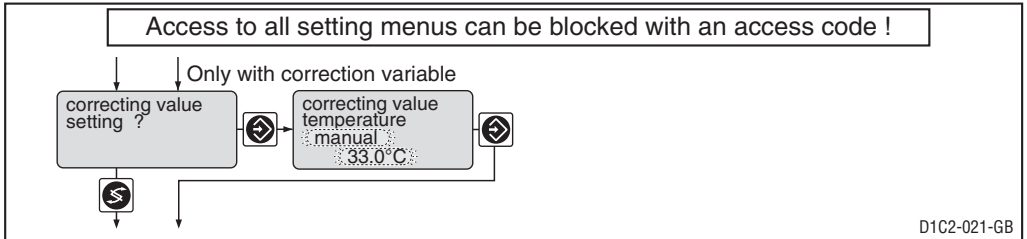

	Initial value	Possible values			Remarks
		Increment	Lower value	Upper value	
Type of temperature compensation	as per identity code	Manual Automatic off			Changeover only if specified in identity code = automatic
Manual temperature compensation	25 °C	0.1 °C	0 °C	100 °C	

Pumps

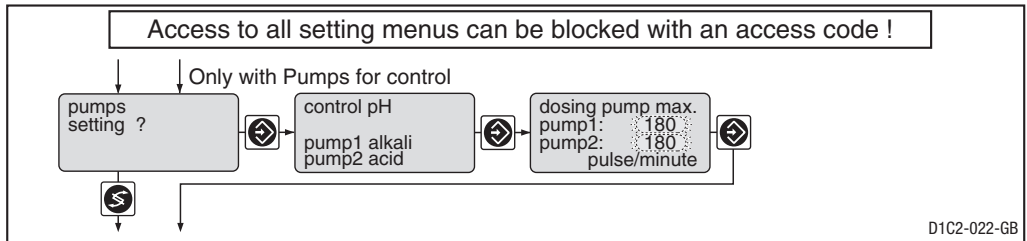

	Initial value	Possible values			Remarks
		Increment	Lower value	Upper value	
Max. stroke/minute of pumps 1 and 2	180	1	1	500	off = 0 strokes/min

Complete Operating Menu / Description

Relay for power control

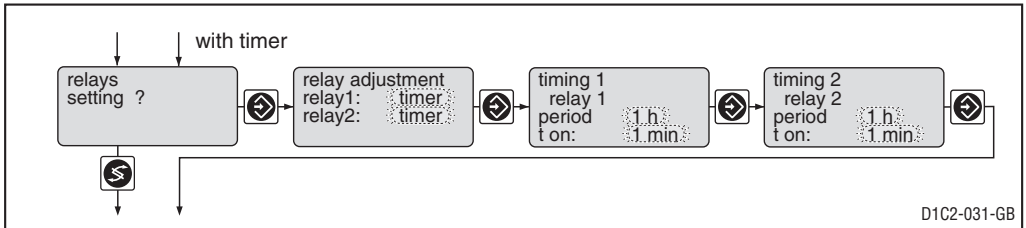
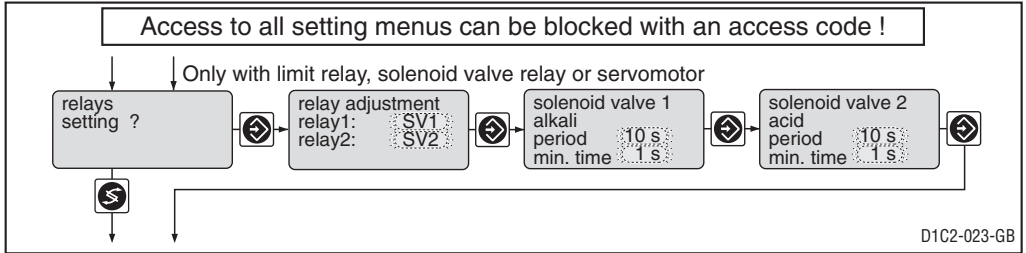

	Initial value	Possible values			Remarks
		Increment	Lower value	Upper value	
Relay adjustment	as per identity code	Solenoid valve Limit value* Actuator Servomotor Timer 1, 2 off			*For "limit value", the relays remain active, even in the event of a fault. only with servomotor
Period (Cycle)	10 s	1 s	10 s	9999 s	for solenoid valve
min. time	1 s	1 s	1 s	period/2	for solenoid valve Set here the smallest permitted operating factor of the connected device.
Period (Cycle)	off	1 h	1 h/off	240 h	for timer
t on	1 min	1 min	1 min	60 min	for timer

NOTE

Limit value relays can also be defined so that they react similarly to a servo component. E.g. if a limit value relay has responded, it opens at the closed contact interval or for a longer time delay t_q (if $t_q > 0$ min is set in "General Setting").

Complete Operating Menu / Description

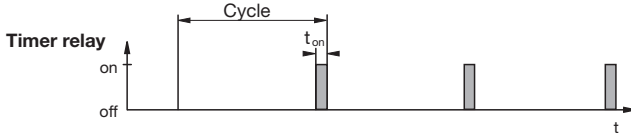

IMPORTANT

The timer will be reset if there is a drop in the power supply.

At the end of the (timer) cycle time the DULCOMETER® D1C closes the assigned relay for the duration of “t on” (timer). “Pause” interrupts the timer.

When the clock is shown in the LC display the timer can be reset to the start of the cycle at precisely this point using the enter button.

The % figure in the LC display indicates the progress of the current cycle.

Timer relays may be used, e.g. for shock metering or sensor cleaning.

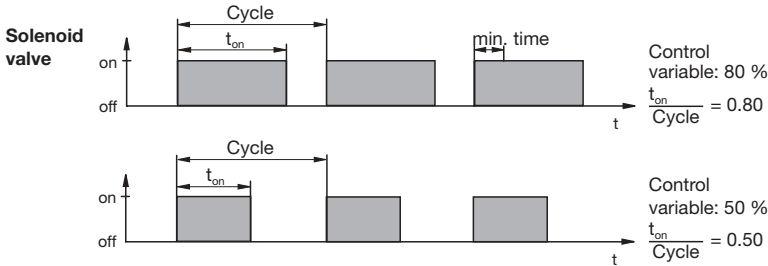

The switching time of the DULCOMETER® D1C (solenoid valve) depends on the control variable and the “min. time” (smallest permitted operating factor of the connected device).

The control variable determines the ratio $t_{on}/cycle$ and thus the switching times (see fig. above).

The “min. time” influences the switching times in two situations:

a) theoretical switching time < min. time:

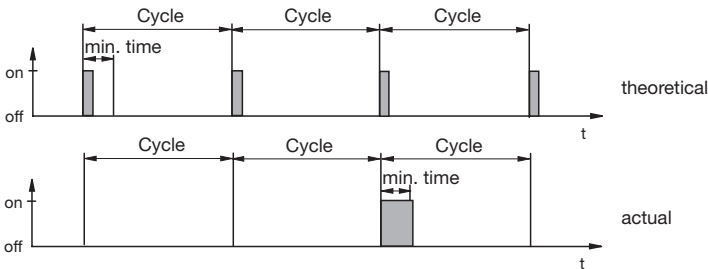

The DULCOMETER® D1C does not switch for a certain number of cycles until the sum of the theoretical switching times exceeds the “min. time”. Then the DULCOMETER® D1C switches for the duration of this total time.

b) theoretical switching time > (cycle - min. time) and calculated switching time < cycle

Complete Operating Menu / Description

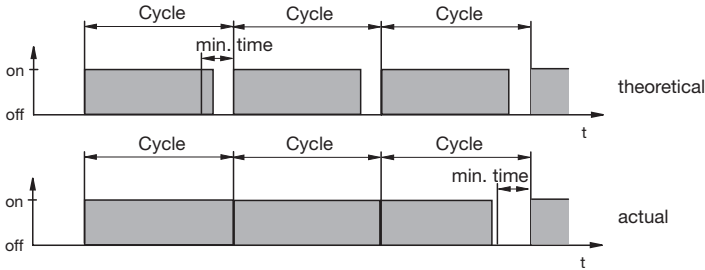

The DULCOMETER® D1C does not deactivate for a certain number of cycles until the differences between cycle and theoretical switching time exceed the “min. time”.

Limits

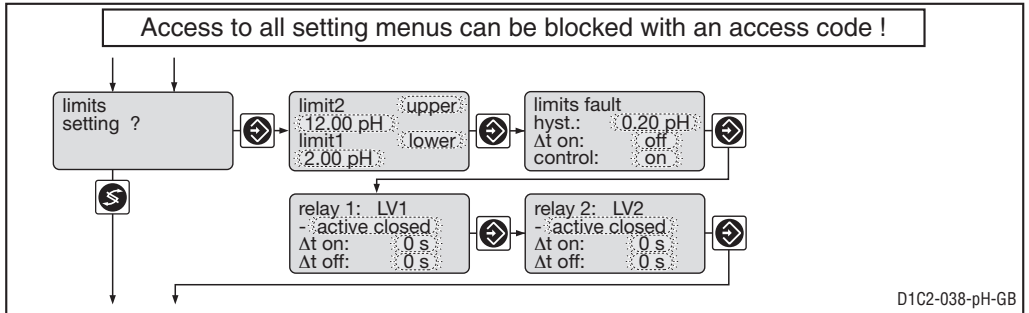

	Initial value	Possible values			Remarks
		Increment	Lower value	Upper value	
Type of limit transgression Limit 1: Limit 2:	lower upper	upper lower off*			Limit transgression when exceeding or dropping below value *only with limit value relay
Limit value Limit 1: Limit 2:	pH 2 pH 12	pH 0.01 pH 0.01	pH -2 pH -2	pH 16 pH 16	
Hysteresis limits	pH 0.2	pH 0.01	pH 0.02	pH 14	Effective in direction of cancelling limit transgression
Checkout time limits Δt on	off	1 s	1 s	9999 s	Results in message and alarm. off = 0 s: Function switched off, no message, no alarm
Control	on	on off			
Switching direction Limit 1; Limit 2	active closed	active closed active opened			Acts as N/O Acts as N/C
Switch-on delay Δt on	0 s	1 s	0 s	9999 s	
Switch-off delay Δt off	0 s	1 s	0 s	9999 s	

Complete Operating Menu / Description

“Limit value 1, lower ” means that the value has dropped below the lower limit.

“Limit value 2, upper” means that the value has exceeded the upper limit.

The DULCOMETER® D1C has the capacity to define a “hysteresis limit value”.

The “hysteresis” works towards eliminating the limit value transgression, i.e. if the “limit value 1 upper” of pH 7.5 has exceeded a pre-set hysteresis limit value of pH 0.20, the criterion for a limit value shortfall of pH 7.3 is not applicable (see diagram below).

The characteristics of an hysteresis for a “limit value, lower” work in a similar way (here, the hysteresis value is added to the limit value). In this way, there is no need for an external self-locking relay. The control characteristics are not affected.

If the limit is exceeded for longer than the “Delay time - limit values” an error message is given, which must be acknowledged, and the alarm relay circuit is broken. If “Controller” is also set to “off” the control process stops.

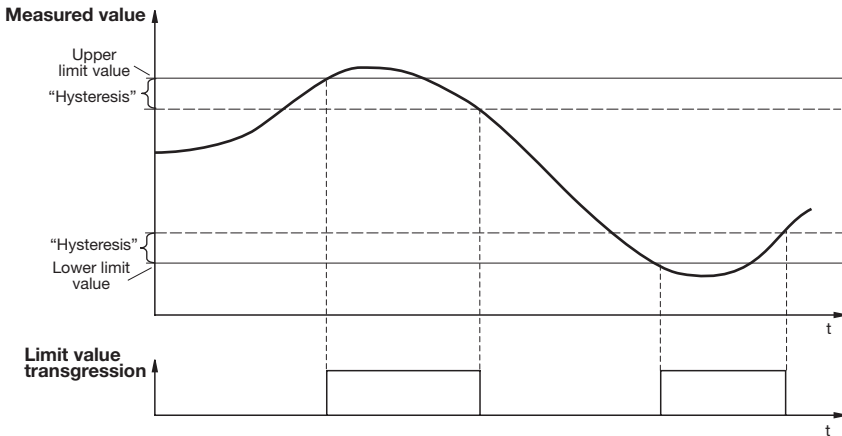

If limit value relays are present and are defined as such (see “relay settings?”), in the event of a limit value transgression they also function as alarm relays and the direction of the limit value transgression will be displayed by the symbol \uparrow or \downarrow .

For the limit value relays different make delays “ Δt on” and different break delays “ Δt off” can be set for limit value 1 and limit value 2. These prevent the limit value relays switching back and forth if the limit value is only momentarily exceeded (damping function).

If no limit value relays are present, limit values can still be defined (as described above). The DULCOMETER® D1C can then display all the reactions to limit value transgression as described above.

Limit value relay as actuator:

If the limit value relays are defined as actuators, they react in the same way as control outputs.

e.g.: in case of an active pause or alarm, the activated limit value relay drops off.

Complete Operating Menu / Description

Servomotor



IMPORTANT

- For a precise performance, the operating time of the stroke adjustment motor being used should not fall below 25 seconds for 0...100% of the operating range and should not exceed 180 s.
- Activation of a stroke adjustment motor must be carried out with the same degree of care as for the calibration of a sensor probe!

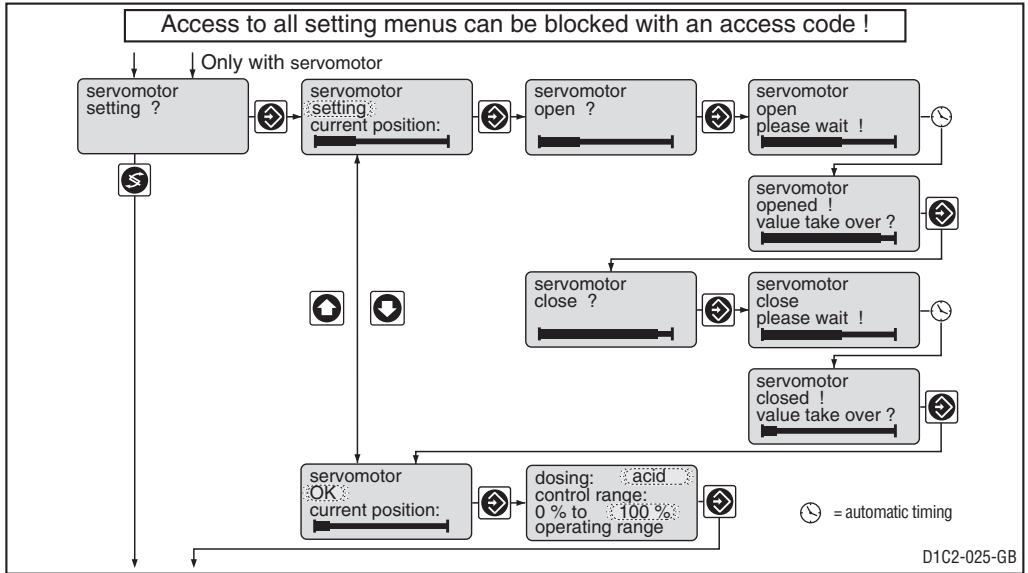

	Initial value	Possible values			Remarks
		Increment	Lower value	Upper value	
Servomotor	Setting	Setting OK off			
Control direction	Acid	Acid Alkali			
Control range	100 %	1 %	10 %	100 %	in % of operating range

NOTE

- If the broad bar is to the far right, the stroke adjustment motor is fully open.
- The continuous display shows the degree (in %) to which it is open (the greater the percentage, the more open the stroke adjustment motor).

The **operating range** is determined by the total resistance range of the potentiometer response signal. Maximum limits are set on the actual range used by fixing the **control range**.

Complete Operating Menu / Description

Control

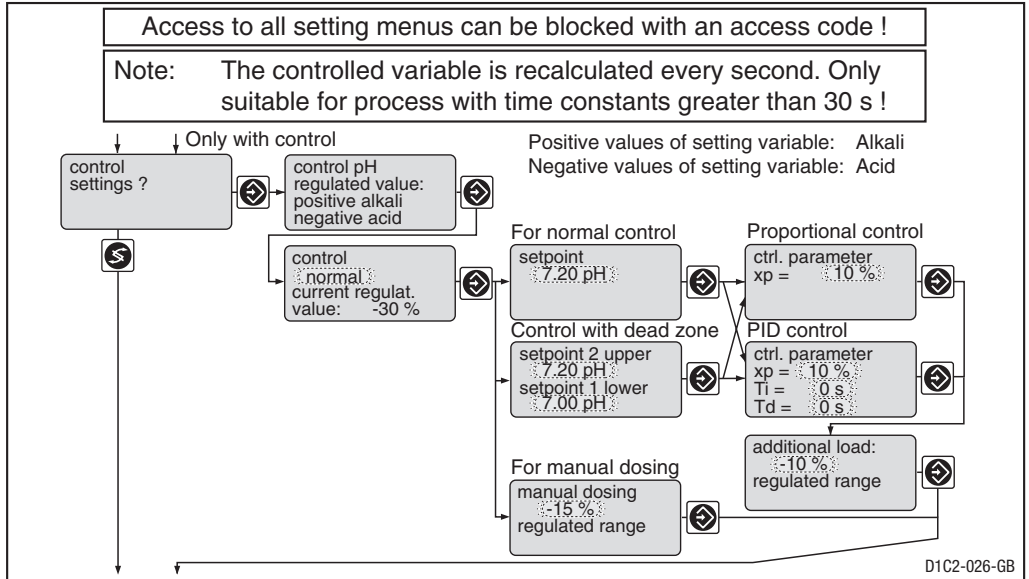

	Initial value	Possible values			Remarks
		Increment	Lower value	Upper value	
Control	normal	normal with dead zone manual			When controlling with dead zone, the feed forward control is not used for measured values within the dead zone.
Setpoint	pH 7	pH 0.01	pH 0	pH 14	2 setpoints necessary for control with dead zone. Setpoint 2 > setpoint 1
Control parameter xp	10 %	1 %	1 %	500 %	xp referred to pH 14
Control parameter Ti	off	1 s	1 s	9999 s	Function off = 0 s
Control parameter Td	off	1 s	1 s	2500 s	Function off = 0 s
Additional load	0 %	1 %	-100 %	+100 %	
Manual metering	0 %	1 %	-100 %	+100 %	

The DULCOMETER® D1C controller can be set up as a P-, PI- or PID-controller. This depends on the system design (see Identity Code) and the control parameter setting.

The control variables are calculated once per second.

These controllers cannot be installed in control circuits, which require a fast cut-out response to control discrepancies (less than approx. 30 seconds).

It is possible to take into account cycle times by activating solenoid valves (pulse-length), and running times by activating stroke adjustment motors (3-point).

The control function (control variable output) can be disabled via the pause control input.

The calculation of the control variable re-commences at the end of the pause and after the expiry of the time delay period t_d .

Complete Operating Menu / Description

Abbreviations for control variables:

- x: Control variable, actual value (e.g. pH-value)
- K_{PR} : Proportional coefficient
- x_p : 100 %/ K_{PR} (inverse proportional coefficient)
- X_{max} : Maximum measuring range of the controller (e.g. pH 14)
- y: Control output (e.g. stroke frequency to the metering pump)
- Y_h : Adjusting range (e.g. 180 strokes/min.)
- y_p : output of P-controller [e.g. %]
- w: Set point (e.g. pH 7.2)
- e: Control difference, $e = w - x$
- x_w : Control deviation, $x_w = x - w$
- T_i : Integration time of I-controller [s]
- T_d : Differential time of D-controller [s]

Control equations

$$x_p = \frac{100 \%}{K_{PR}} \quad x_p = 100 \% * \frac{e}{Y_h}$$

This formula helps you to find out the x_p at which control difference the control output is 100 %.

Control equation of P-controller:

$$y_p = 100 \% * \frac{Y_h * (w - x)}{X_{max} * x_p}$$

Example for Y_p :

$x_p = 10 \%$, control deviation 1,4 pH
(10 % of max. measuring range)

$$y_p = 100 \% * \frac{180 \text{ strokes/min} * (\text{pH } 7 - \text{pH } 5.6)}{10 \% * \text{pH } 14}$$

= 180 strokes/min.

Control equations of PID-controller:

$$y = \underbrace{y_p}_{\text{P-control}} + \underbrace{\frac{1}{T_i} \int y_p dt}_{\text{I-control}} + \underbrace{T_d \frac{dy_p}{dt}}_{\text{D-control}}$$

Complete Operating Menu / Description

Standard

A measured value is compared with a setpoint. In the case of a standard difference (difference between setpoint minus actual value) a control variable is determined which counteracts the standard difference.

Types of controller are as follows:

P-controller: found in applications in integrated control systems (e.g. batch neutralisation).

PI-controller: can be used in non-integrated control systems (e.g. continuous neutralisation)

PID-controller: found in applications in which peaks occur and which must be switched off.

With dead zone

With a dead zone control (neutral zone control) two setpoints must be given. If the measured value falls within the dead zone, no control variable is output.

Setpoint 2 must be greater than setpoint 1!

Manual



IMPORTANT

The controller does not automatically exit this mode of operation.

The manual operating mode may be used for commissioning and test purposes only.

No control.

A control variable is manually specified:

Control variable: 0...+100% (control output actively rises)

Control variable: -100...0% (control output actively falls)

This function acts as a check for servo components.

Additional basic load

A basic load is added to the current control variable.

With the additional basic load, for example, values can be kept constant.

$$Y_{\text{tot}} = Y_p + 15 \% \quad (\text{additional basic load} = 15 \%)$$

Example 1:

$$Y_{\text{tot}} = 85 \% + 15 \%$$

$$\underline{Y_{\text{tot}} = 100 \%}$$

Example 2:

$$Y_{\text{tot}} = -75 \% + 15 \%$$

$$\underline{Y_{\text{tot}} = -60 \%}$$

Complete Operating Menu / Description

Feed forward control

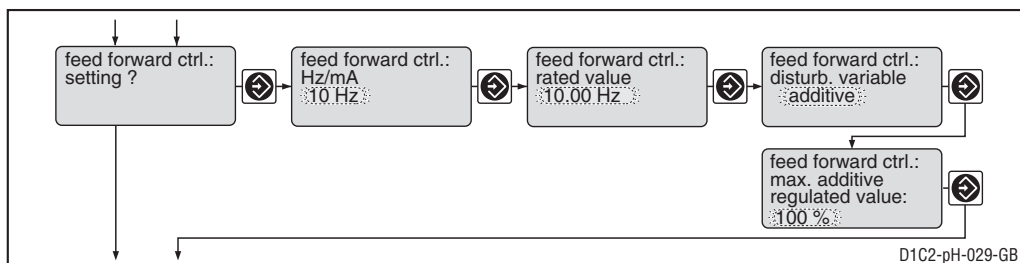

	Initial value	Possible values			Remarks
		Increment	Lower value	Upper value	
Feed forward control (Flow)	as per identity code	None 10 Hz 500 Hz			Signal processing: Signal <0,02 Hz = No flow Signal <0,2 Hz = No flow Signal <0,2 mA = No flow Signal <4,2 mA = No flow Depended on signal type. Maximum limitation of range used.
	Standard signal 4–20 mA	0...20 mA 4...20 mA			
Feed forward control rated value	10 Hz 500 Hz 20 mA	0.01 Hz 1 Hz 0.1 mA	0.1 Hz 5 Hz 0.4 mA	10 Hz 500 Hz 20 mA	
Feed forward control effect	multiplicative	multiplicative additive			
Max. add. regulated value	100 %	1 %	-500 %	+500 %	only with add. feed forward control

The DULCOMETER® D1C controller can, for example, process a signal from a flow measurement as a feed forward signal. This feed forward signal impacts on the control variable, calculated by the controller, which is dependent on this external signal.

Depending on the type of impact on the control variable, there can be:

- multiple feed forward signals (impact proportional to flow)
- additional feed forward signals (impact dependent on feed forward signals)

This feed forward signal can exist as a 0/4 ... 20 mA-signal or as a digital contact signal with maximum frequencies of up to 10 Hz or up to 500 Hz (depending on identity code and settings).

During “commissioning”, the zero point-signal of the flow meter must be checked without flow (must be ≥ 0).

Complete Operating Menu / Description

Multiple feed forward signal

This type of feed forward signal processing is used, e.g. in continuous neutralisation.

The control variable determined by the controller is multiplied by a factor of F. The factor lies within the range $0 \leq F \leq 1$ ($0 \cong 0 \%$, $1 \cong 100 \%$). The control variable can therefore amount to a maximum 100 %.

$$\text{Control variable for control element [\%]} = \frac{\text{Measured control variable [\%]} * \text{current feed forward signal [mA]}}{\text{Set feed forward signal [mA]}}$$

A “current feed forward signal” greater than or equal to the “fixed feed forward signal” does not affect the control variable (see example 2 and 3 in the table).

Examples:

Description	Unit	1.	2.	3.	4.
Measured control variable	%	50	50	50	0
Current feed forward signal (for 0-20mA)	mA	5	10	20	15
Set feed forward signal	mA	10	10	10	10
Factor F	-	0,5 (50 %)	1 (100 %)	1 (100 %)	1 (100 %)
Final control variable	%	25	50	50	0

Legend:

The measured control variable is the control variable which the controller would output without a feed forward signal.

The set feed forward signal limits the range used.

Example: a flow meter is installed, which can measure a maximum flow of $Q = 250 \text{ m}^3/\text{h}$. The analogue output of the flow meter issues a signal corresponding to $4 \text{ mA} = 0 \text{ m}^3/\text{h}$, $20 \text{ mA} = 250 \text{ m}^3/\text{h}$. However, the maximum flow achievable in the application is only $125 \text{ m}^3/\text{h}$. If the flow meter’s standard output signal is not adjusted to the range of 4...20 mA of the D1C (is possible with most flow meters), the standard signal of $125 \text{ m}^3/\text{h}$ only amounts to 12 mA. This value is then fed into the Menu “Set feed forward signal?” under “Set feed forward signal”.

The feed forward signal is the prevailing analogue current running through the flow meter. The final control variable is transferred to the servo component.

 **IMPORTANT**
The multiplicative disturbance signal is not designed for the control variable to be permanently switched off!
You should plan to disconnect using the Pause function.

Additional feed forward signal

The additional feed forward signal lock is suitable for dosing applications, whose dosing quantity depends primarily on the feed forward signal (e.g. flow) and only needs slight correction afterwards. This type of feed forward signal processing is used, e.g. in the chlorination of water with almost constant chlorine consumption capacity.

Complete Operating Menu / Description

One of the basic dosages dependent on the feed forward signal is added to or subtracted from the “measured control variable” previously determined by the controller. The control variable can amount to a maximum of 100 %.

Control variable for the servo component [%] =

$$\text{Measured control variable [\%]} + \left(\frac{\text{max. additive control variable [\%]} * \text{actual current feed forward signal [mA]}}{\text{Fixed feed forward signal [mA]}} \right)$$

Exemples:

Description	Unit	1.	2.	3.	4.	5.	6.
Measured control variable	%	40	90	50	50	50	0
Current feed forward signal (for 0-20 mA)	mA	5	5	2	10	20	5
Set feed forward signal	mA	10	10	10	10	0	10
Max. add. control variable	%	100	-100	200	200	200	100
Final control variable	%	90	40	90	100	50	50

Legend:

The maximum additional feed forward signal indicates which feed forward signal maximum should be added (where current feed forward signal = fixed feed forward signal).

For further legend see “Multiple feed forward signals”.



IMPORTANT

If no current feed forward signal is available (flow = 0) but there is a control variable established by the PID controller, the final control variable corresponds to the control variable established by the PID controller. If a current feed forward signal is present (flow > 0) and the control variable established by the PID controller is also “0”, then the final control variable corresponds to the 2nd part of the aforementioned formula:

$$\frac{\text{Max. additional current feed forward signal} * \text{actual current feed forward signal}}{\text{set feed forward signal}}$$

Complete Operating Menu / Description

Standard Signal Output 1

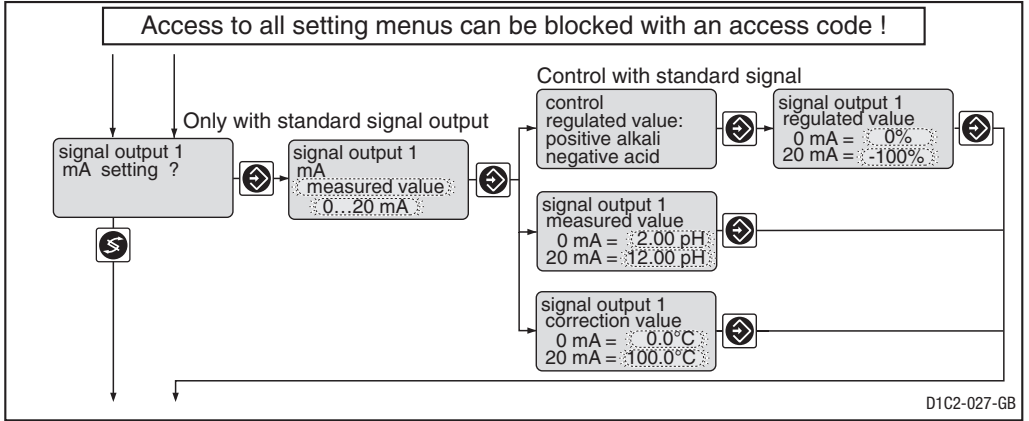

Standard Signal Output 2

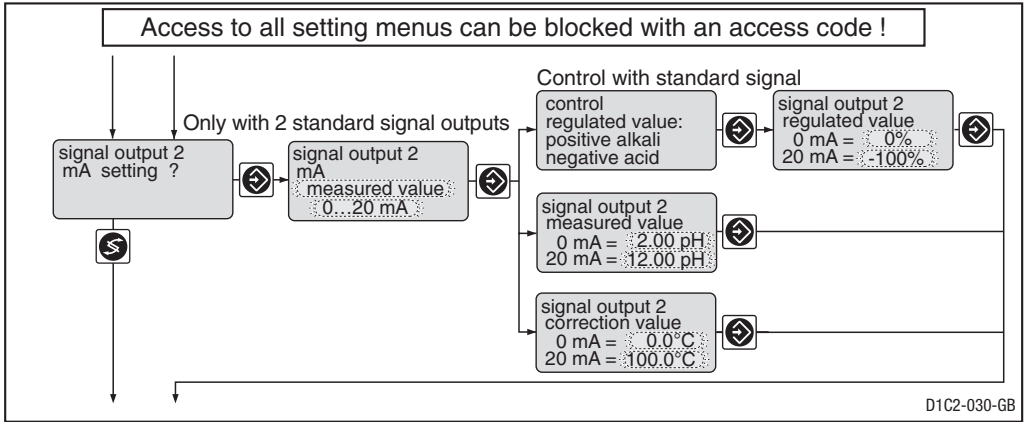

	Initial value	Possible values			Remarks
		Increment	Lower value	Upper value	
Variable allocation	as per identity code	Measured value Controlled variable Correction value			If control applicable only with correction variable
Output range	0...20 mA	0...20 mA 4...20 mA 3.6/4-20 mA			
Range measured value	pH 2...pH 12	pH 0,01	pH -2	pH 16	Minimum range pH 0.1
Range controlled variable	-100 %...0 %	1 %	-100 %	+100 %	Minimum range 1 %
Range correction value	0...100 °C	0.1 °C	0 °C	100 °C	Minimum range 1 °C

Complete Operating Menu / Description

General setting

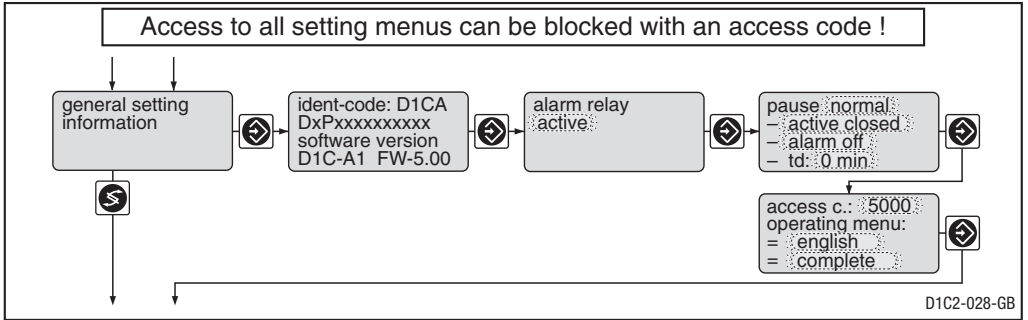

	Initial value	Possible values		Lower value	Upper value	Remarks
		Increment				
Alarm relay	active	active not active				
Pause	normal	normal Hold				
Control input pause	active closed	active closed active open				
Alarm Pause	alarm off	alarm off alarm on				Alarm relay can be activated through pause contact.
td	0 min	1 min	0 min	60 min		
Access code	5000	1	1	9999		
Language	as per identity code	as per identity code				
Operating menu	complete	reduced complete				

Complete Operating Menu / Description

Standard Pause

If the pause-switch is off, the DULCOMETER® D1C sets the operating outputs to “0” for as long as the pause-switch is off or for a set time-delay t_d (if t_d is set to > 0 min). Whilst the pause-switch is off, the D1C establishes the P-proportion in the background.

With PID-control (Identity code characteristics “control characteristic” = 2): the I-proportion is stored when the pause is switched off (I-proportion then usually only present if $T_n > 0$ has been selected in the “Control setting?” setting menu).

Exception: the standard signal outputs mA for the measured value or correction value are not affected by the pause.

After pause is activated the operating outputs remain at “0” for the length of the time-delay t_d . The time-delay t_d must be set up in such a way that, in this time e.g. sample water (process-specific current concentration) flows to the sensor.

With PID-control (Identity code characteristics “control characteristic” = 2): The control variable output resulting from the pause and the expiry of the time-delay t_d is reconciled jointly with the current P-component and (if T_n is set > 0) with the stored I-component.

Pause Hold

If the pause-switch is off, the DULCOMETER® D1C freezes the operating output at the most recent value for as long as the pause-switch is off or for a set time-delay t_d (if t_d is set to > 0 min). Whilst the pause-switch is off, the D1C establishes the P-proportion in the background.

With PID-control (Identity code characteristics “control characteristic” = 2):

Even the mA standard signal outputs for measured value or correction value are frozen.

After pause is activated the operating outputs remain frozen for the length of the time delay t_d . The time delay t_d must be set up in such a way that, in this time e.g. sample water (process-specific current concentration) flows to the sensor.

With PID-control (Identity code characteristics “control characteristic” = 2): The control variable output resulting from the pause and the expiry of the time-delay t_d is reconciled jointly with the current P-proportion and (if T_n is set > 0) with the newly established I-proportion.

Access Code

Access to set up menus can be restricted by setting up access codes. The D1C controller is supplied with the access code 5000, which permits free access to set up menus. Even with restrictions using access codes, the calibration menu remains freely accessible.

8 Faults / Notes / Troubleshooting

Fault	Fault text	Symbol	Effect On metering	Effect On Control	Alarm with ack- nowledgement	Remarks	Remedy
Measured value Checkout time measured value exceeded	Check pH probe	☹	Basic load	Stop	Yes	Function can be switched off	Check function of probe, extend check time
Signal exceeded/drops below value	Check pH input	☹	Basic load	Stop	Yes	Signal <3.0 mA ±0.2 mA or >23 mA ±0.2 mA	Check probe, transducer and cable connection
Calibration with error	pH calibration defect	☹	Basic load	Stop	No	Metering continues in case of error with unsteady measured values	Check probe, replace if necessary, recalibrate if necessary
Correction variable Signal exceeded/drops below value	Temp. Input ↕	☹	Basic load	Stop	Yes	PT100-Signal >138.5 Ω Signal <3.0 ±0.2 mA or >23 ±0.2 mA Value last valid is used	Check probe, transducer and cable connection
Feed forward control Signal exceeded/drops below value	Check feed forward input	☹			Yes	Signal <4.0 mA ± 0.2 mA or >23 mA ± 0.2 mA Value last valid is used	Check probe, transducer and cable connection
Limit transgression Control "on" Control "off"	pH limit 1 pH limit 2	☹ ☹	Stop or Basic load	Stop	Yes Yes	Function can be switched off	Define cause, reset values if necessary
Servomotor Electronics error	Position not reached Servomotor defective System error	☹ ○	Stop	Stop	Yes Yes	Servomotor closes Elektronik data defective	Check servomotor Call in service

Error Messages

Error messages and information are indicated on the bottom line in the permanent display 1. Errors to be acknowledged (acknowledgement switches off the alarm relay) are indicated by the "☹". Errors/notes which still apply after acknowledgement are indicated alternately. During correction variable processing (temperature for correction of pH-value), the value is indicated in the same line as the error/note. Faults which are rectified of their own accord due to changed operating situations are removed from the permanent display without the need for acknowledgement.

Faults / Notes / Troubleshooting

Operation	Note text	Symbol	Effect on metering	Effect on control	Alarm with acknowledgement	Remarks	Remedy
Pause contact	Pause	EO	Stop	Stop	No/Yes*	No further fault check	-
	Pause/hold	E		PI-part frozen			
Stop button	Stop	EO	Stop	Stop	No	Relay drops out	-
During calibration			Basic load	Stop	No	No error processing of measured variable	-
	Buffer spacing too small	E					Recalibrate
Probe zero point too low Probe zero point too high Probe slope too low Probe slope too high	Buffer distance too small! Δ buffer >2 pH!						
	pH zero point low						
	pH zero point high						
	pH slope low						
Probe slope too high	pH slope high		Basic load	Stop	No		Check probe, replace if necessary
	Measured value unsteady						
During servomotor setting Position feed back wrong Upper position <40 % max. value Lower position >30 % range	Direction check						Check connection of relay, potentiometer
	Final value small						Adjust the operation region of the servomotor correctly
	Final value big					Without correct adjustment the last valid values are still used	

*dependent on whether "Alarm on" or "Alarm off" is set in "General settings"
