



Operating Instructions

DULCOMETER® D1C

Part 2: Adjustment and Operation, Measured Variable Temperature

D1C2-Temp.-001-GB

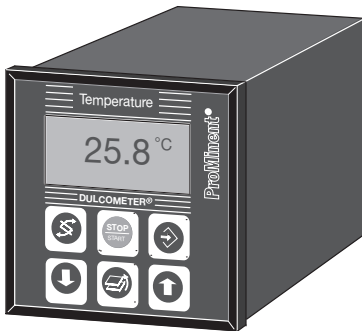

Type D

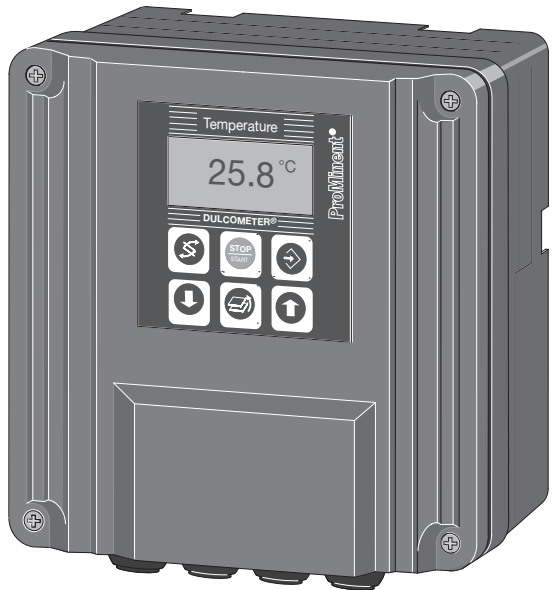

Type W

D1C A _____

Please enter the identity code of your device here!

**Please completely read through the operating instructions! · Do not discard!
The warranty shall be invalidated by damage caused by operating errors!**

1 Device Identification / Identity Code

D1C A		DULCOMETER® Controller Series D1C / Version A	
		Type of mounting	
D		Control panel installation 96 x 96 mm	
W		Wall mounting	
		Operating voltage	
0		230 V 50/60 Hz	
1		115 V 50/60 Hz	
2		200 V 50/60 Hz (only with control panel installation)	
3		100 V 50/60 Hz (only with control panel installation)	
4		24 V AC/DC	
		Measured variable	
T		Temperature (0-100 °C; 32-212 °F)	
		Connection of measured variable	
1		Terminal, standard signal 0/4-20 mA	
5		Terminal mV	
		Correction variable	
0		None	
		Feed forward control	
0		None	
1		As standard signal 0/4-20 mA	
2		As frequency 0-500 Hz	
3		As frequency 0-10 Hz	
		Control input	
0		None	
1		Pause	
		Signal output	
0		None	
1		Standard signal 0/4-20 mA measured value	
2		Standard signal 0/4-20 mA control variable	
3		Standard signal 0/4-20 mA correction variable	
4		2 standard signal 0/4-20 mA outputs, free programmable	
		Power control	
G		Alarm and 2 limit value/timer relays	
M		Alarm and 2 solenoid valve relays	
R		Alarm relay and servomotor with feedback	
		Pump control	
0		None	
2		Two pumps	
		Control characteristic	
0		None	
1		Proportional control	
2		PID control	
		Log output	
0		None	
		Language	
D		German	
E		English	
F		French	
I		Italian	
N		Dutch	
S		Spanish	
P		Polish	
A		Swedish	
U		Hungarian	
G		Czech	
T		Thai	
K		Korean	
C		Chinese	

D1C A

Please enter the identity code of your device here!

2 General User Information

	Page
1 Device Identification / Identity Code	2
2 General User Information	3
3 Device Overview / Controls	4
4 Functional Description	5
5 Display Symbols	6
6 Operation diagram	7
7 Restricted Operating Menu	8
General Layout	8
Description	9
8 Complete Operating Menu	12
Overview	12
Description	13
9 Faults / Notes / Troubleshooting	24

General User Information

These operating instructions describe the technical data and function of the series DULCOMETER® D1C controller, provide detailed safety information and are divided into clear steps.



IMPORTANT



- *Please observe the parts of these operating instructions applicable to your particular version! This is indicated in the Section “Device Identification / Identity Code”.*
- *Correct measuring and metering is only possible in the case of impeccable operation of the sensor. The sensor has to be calibrated / checked regularly!*

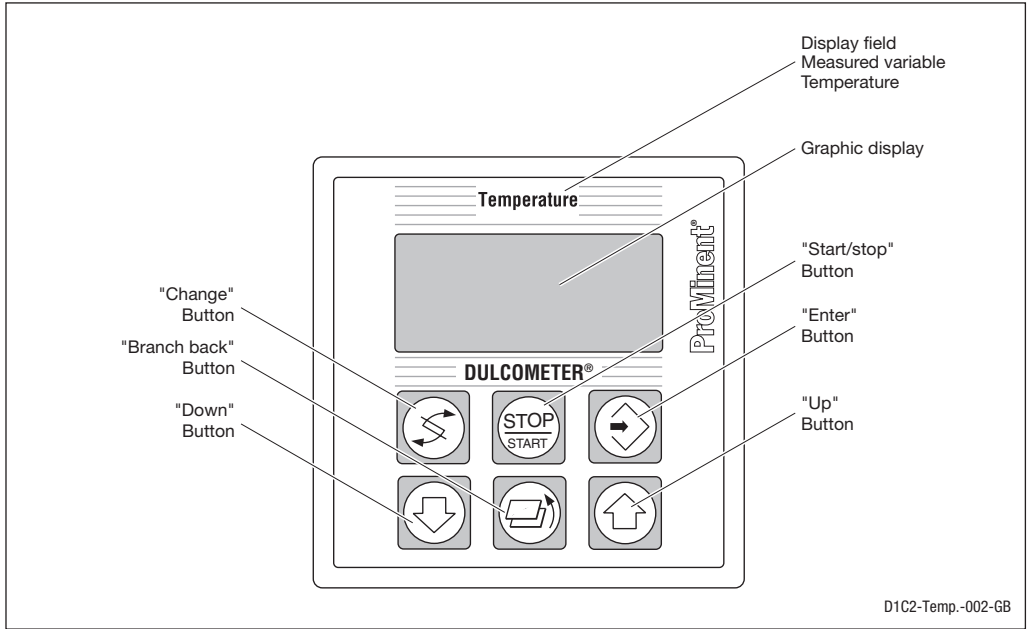

NOTE

A form “Documentation of controller settings type D1C” is available under www.prominent.com/documentation_D1C for the purpose of documenting the controller settings.

3 Device Overview / Controls



	<p>CHANGE button</p> <p>To change over within a menu level and to change from one variable to another within a menu point.</p>
	<p>START/STOP button</p> <p>Start/stop of control and metering function.</p>
	<p>ENTER button</p> <p>To accept, confirm or save a displayed value or status. For alarm acknowledgement.</p>

	<p>UP button</p> <p>To increase a displayed numerical value and to change variables (flashing display)</p>
	<p>BRANCH BACK button</p> <p>Back to permanent display or to start of relevant setting menu.</p>
	<p>DOWN button</p> <p>To decrease a displayed numerical value and to change variables (flashing display).</p>

4 Functional Description

NOTE

Please refer to the description of the complete operating menu in Section 8 for a detailed description of the individual characteristics of the DULCOMETER® D1C controller!

4.1 Operating Menu

The DULCOMETER® D1C controller permits settings to be made in two different menus. All values are preset and can be changed in the **complete operating menu**.

The controller is delivered with a **restricted operating menu** so that the D1C controller can be used effectively in many applications from the very onset. If adaptations prove to be necessary, all relevant parameters can then be accessed by switching over to the complete operating menu (see "General settings").

4.2 Access Code

Access to the setting menu can be prevented by setting up an access code. The D1C controller is supplied with the access code 5000 which permits free access to the setting menu. The calibration menu remains freely accessible even if access to the setting menu is blocked by the code.

4.3 Control

The D1C can operate as a proportional controller or as a PID controller - depending on the device version (see identity code) and the setting.

The controlled variable is recalculated once a second. Control procedures which require rapid correction of setpoint deviations (less than approx. 30 seconds) cannot be processed with this controller. The cycle times must be taken into consideration when activating solenoid valves (pulse length) in the same way as their running times when activating servomotors (3-point).

Via the control input pause, the control function (selection of controlled variable) can be switched off. The calculation of the controlled variable starts again after cessation of "pause".

4.4 Feed Forward Control

The D1C controller can process a signal of a feed forward control. Depending on the device version (see identity code) and the setting, this signal can be obtained in any form of a 0–20 mA or 4–20 mA signal or as a digital contact signal with the maximum frequencies 10 Hz or 500 Hz.

This signal can be used, for example, for flow-proportional metering (multiplicative effect) or feed forward-dependent basic load metering (additive effect). The result of control variable calculation from the proportional or PID control is multiplied by or added to the feed forward signal. A multiplicative feed forward variable at the level of the set rated value carries over the calculated control variable unchanged into the controlled variable:

$$\text{Controlled variable} = \text{Feed forward variable/rated value} \times \text{calculated control variable}$$

During start-up, the zero point has to be checked. The multiplicative feed forward control is not designed for switching off permanently the actuating variable (signal ≈ 0).

An additive feed forward variable at the level of the rated value results in maximum controlled variable:























$$\text{Controlled variable (max. 100 \%)} = \text{Feed forward variable/rated value} \times \text{max. controlled variable} + \text{calculated control variable}$$

4.5 Error Messages

Error messages and information are indicated on the bottom line in the permanent display 1. Errors to be acknowledged (acknowledgement switches off the alarm relay) are indicated by the "E". Errors/notes which still apply after acknowledgement are indicated alternately. During correction variable processing (temperature for correction of fluoride-value), the value is indicated in the same line as the error/note. Faults which are rectified of their own accord due to changed operating situations are removed from the permanent display without the need for acknowledgement.

5 Display Symbols

The display of the DULCOMETER® D1C controller uses the following symbols:

Description	Comment	Symbol
Limit value transgression Relay 1, upper	Symbol left	
Relay 1, lower	Symbol left	
Relay 2, upper	Symbol right	
Relay 2, lower	Symbol right	
Metering pump 1 (heat) Control off	Symbol left	
Control on	Symbol left	
Metering pump 2 (cool) Control off	Symbol right	
Control on	Symbol right	
Solenoid valve 1 (heat) Control off	Symbol left	
Control on	Symbol left	
Solenoid valve 2 (cool) Control off	Symbol right	
Control on	Symbol right	
Servomotor Control, open relay		 
Control, close relay		 
Without control		 
Position feedback	The bar increases from left to right during opening	
Stop button pressed		
Manual metering		
Fault		

6 Operation diagram

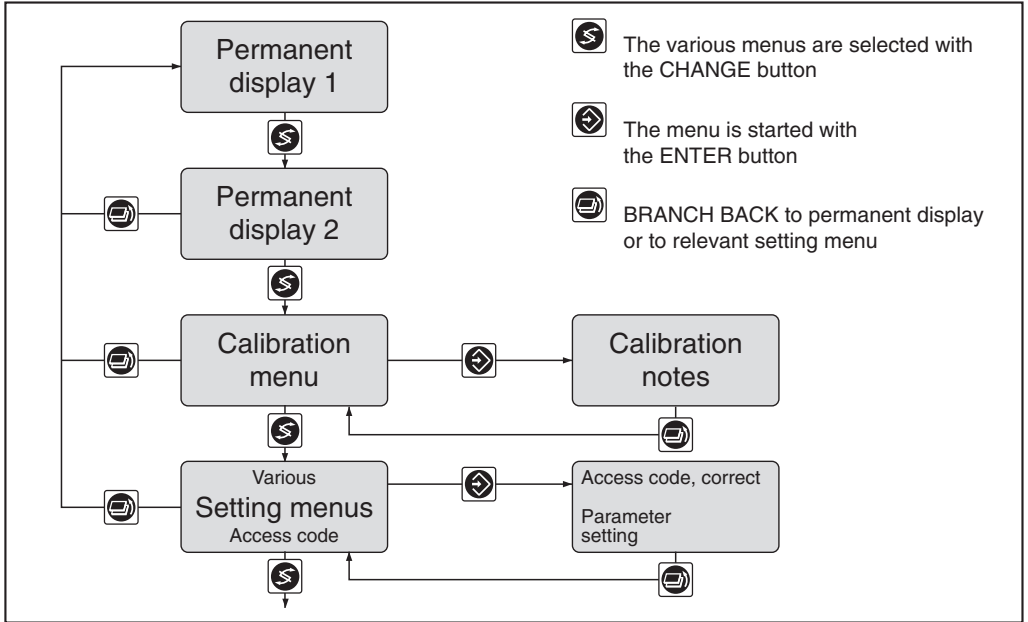

NOTE

Access to the setting menus can be barred with the access code!

The number and scope of setting menus depends on the device version!

If the access code is selected correctly in a setting menu, the following setting menus are also accessible!

If within a period of 10 minutes no button is pushed, the unit automatically branches back from the calibrating menu or a setting menu to the permanent display 1.

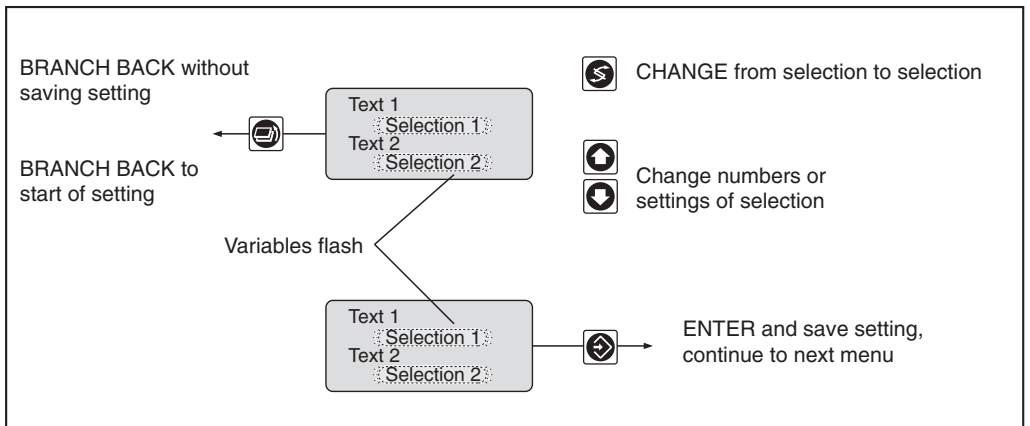

7 Restricted Operating Menu / General Layout

The restricted operating menu permits simple operation of the most important parameters. The following overview shows the settings which can be selected:

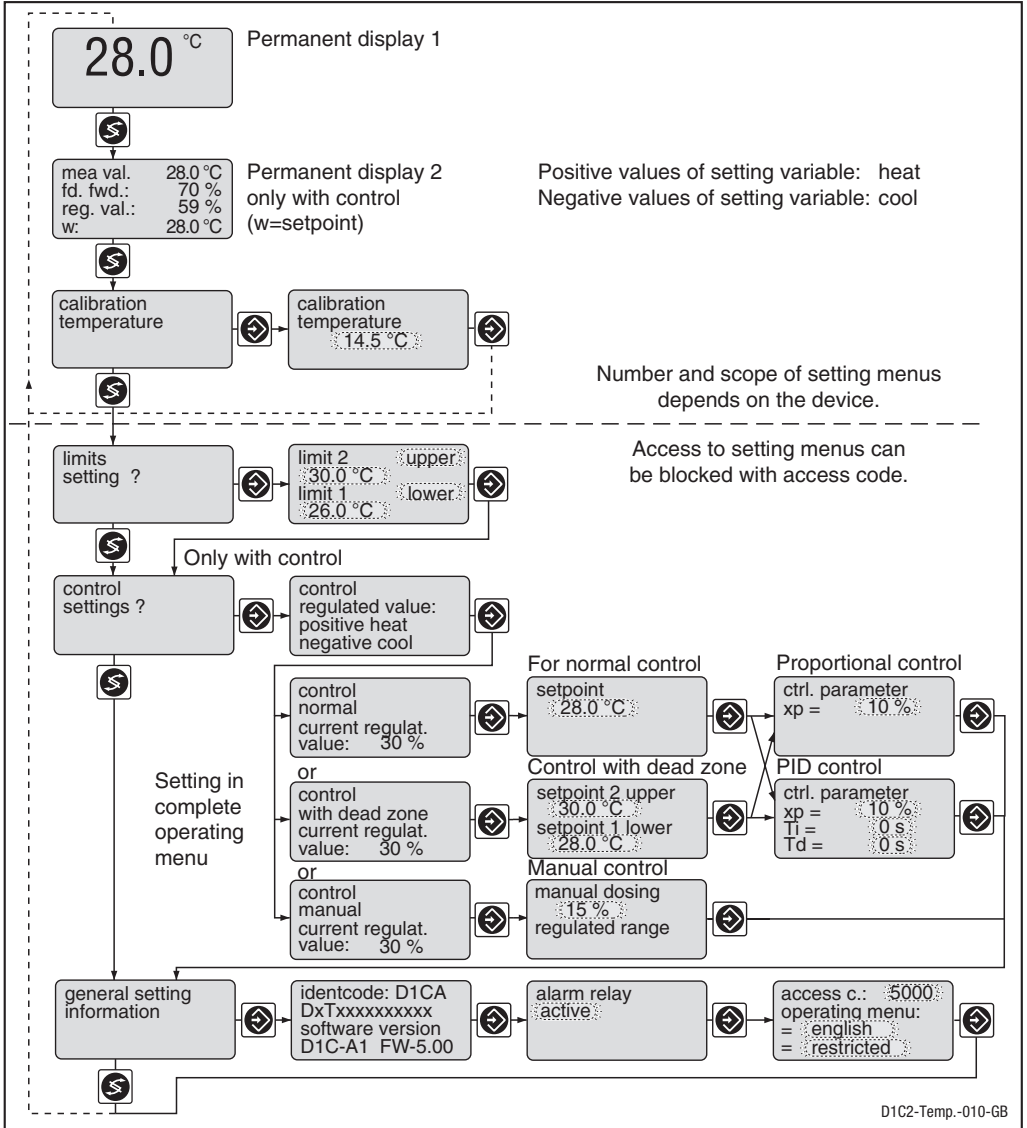

Restricted Operating Menu / Description

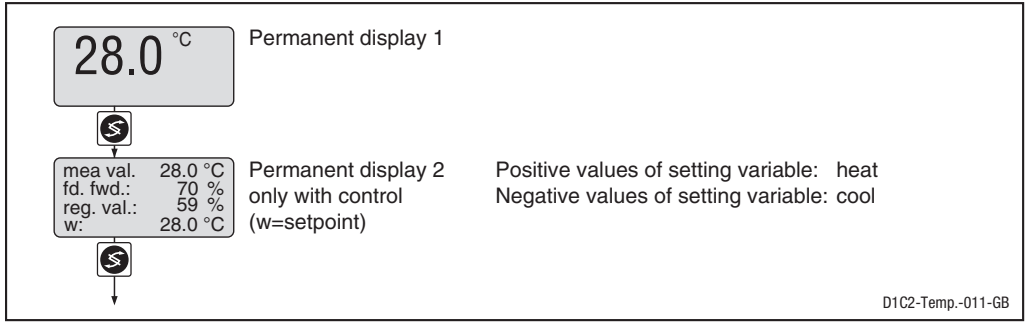

Calibrating the Pt100

During calibration, the control function persists. The standard signal of the output (measured value) remains unchanged. The measured value registered during the start of the calibration is proposed as value; this value is adjustable.



IMPORTANT

A change of the measuring unit (see page 14) must be done before calibration!

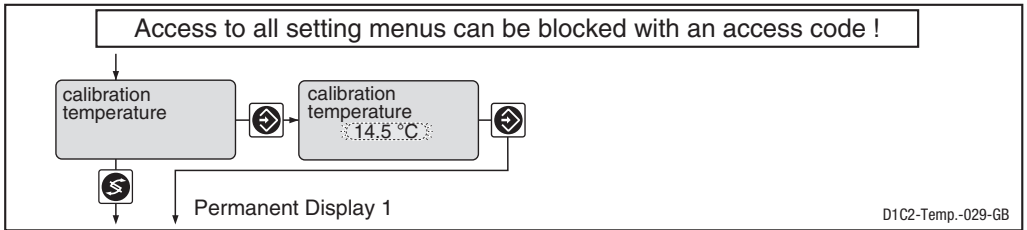

	Initial value	Possible values			Remarks
		Increment	Lower value	Upper value	
Measured value		0.1 °C 0.1 °F	-5 °C 23 °F	105 °C 221 °F	

Restricted Operating Menu / Description

Limit values

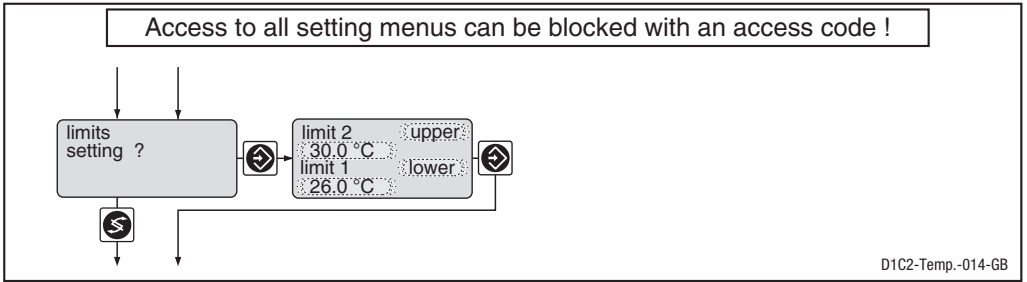

	Initial value	Possible values		Remarks	
		Increment	Lower value		Upper value
Type of limit transgression	Limit 1: lower Limit 2: upper	upper lower off*		Limit transgression for exceeding or dropping below limit *only with limit value relay	
Limit value	Limit 1: 26.0 °C	0.1 °C	-5 °C	105 °C	Measuring unit °C
	Limit 2: 30.0 °C	0.1 °C	-5 °C	105 °C	
	Limit 1: 78.8 °F	0.1 °F	23 °F	221 °F	Measuring unit °F
	Limit 2: 86 °F	0.1 °F	23 °F	221 °F	

Control

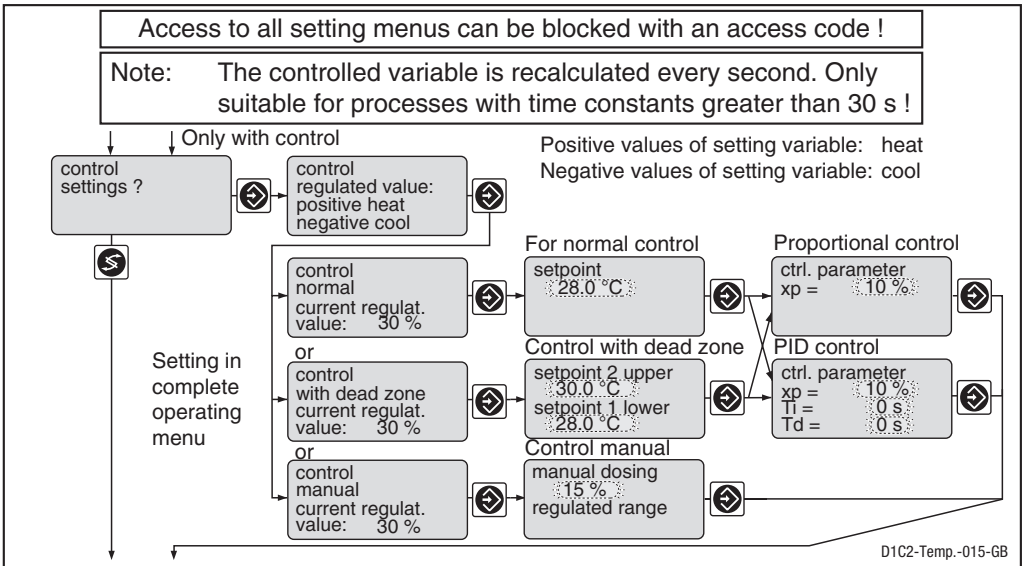

Restricted Operating Menu / Description

	Initial value	Possible values			Remarks
		Increment	Lower value	Upper value	
Setpoint	28.0 °C 82.4 °F	0.1 °C 0.1 °F	-5.0 °C 23 °F	105 °C 221 °F	Measuring unit: °Celsius Measuring unit: °Fahrenheit 2 setpoints necessary for control with dead zone. Setpoint 2 > setpoint 1
Control parameter xp	10 %	1 %	1 %	500 %	xp referred to measuring range
Control parameter Ti	off	1 s	1 s	9999 s	Function off = 0 s
Control parameter Td	off	1 s	1 s	2500 s	Function off = 0 s
Manual metering	0 %	1 %	-100 %	+100 %	

Abbreviation for control variables:

x_p = 100 %/Kp (inverse proportional coefficient)

T_i = I controller integration time [s]

T_d = D controller differential time [s]

General settings

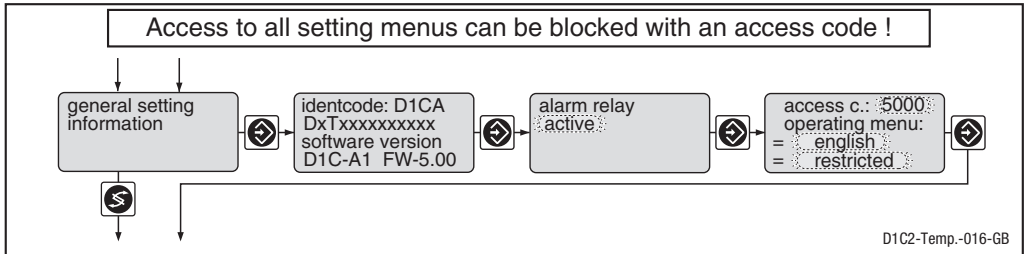

	Initial value	Possible values			Remarks
		Increment	Lower value	Upper value	
Alarm relay	active	active not active			
Access code	5000	1	1	9999	
Language	as per identity code	as per identity code			
Operating menu	restricted	restricted complete			

Access Code

Access to the setting menu can be prevented by setting up an access code. The DULCOMETER® D1C controller is supplied with the access code 5000 which permits free access to the setting menu. The calibration menu remains freely accessible even when access to the setting menu is blocked by the code.

8 Complete Operating Menu / Overview

All parameters of the controller can be set in the complete operating menu (access see previous page). The following overview shows the settings which can be selected:

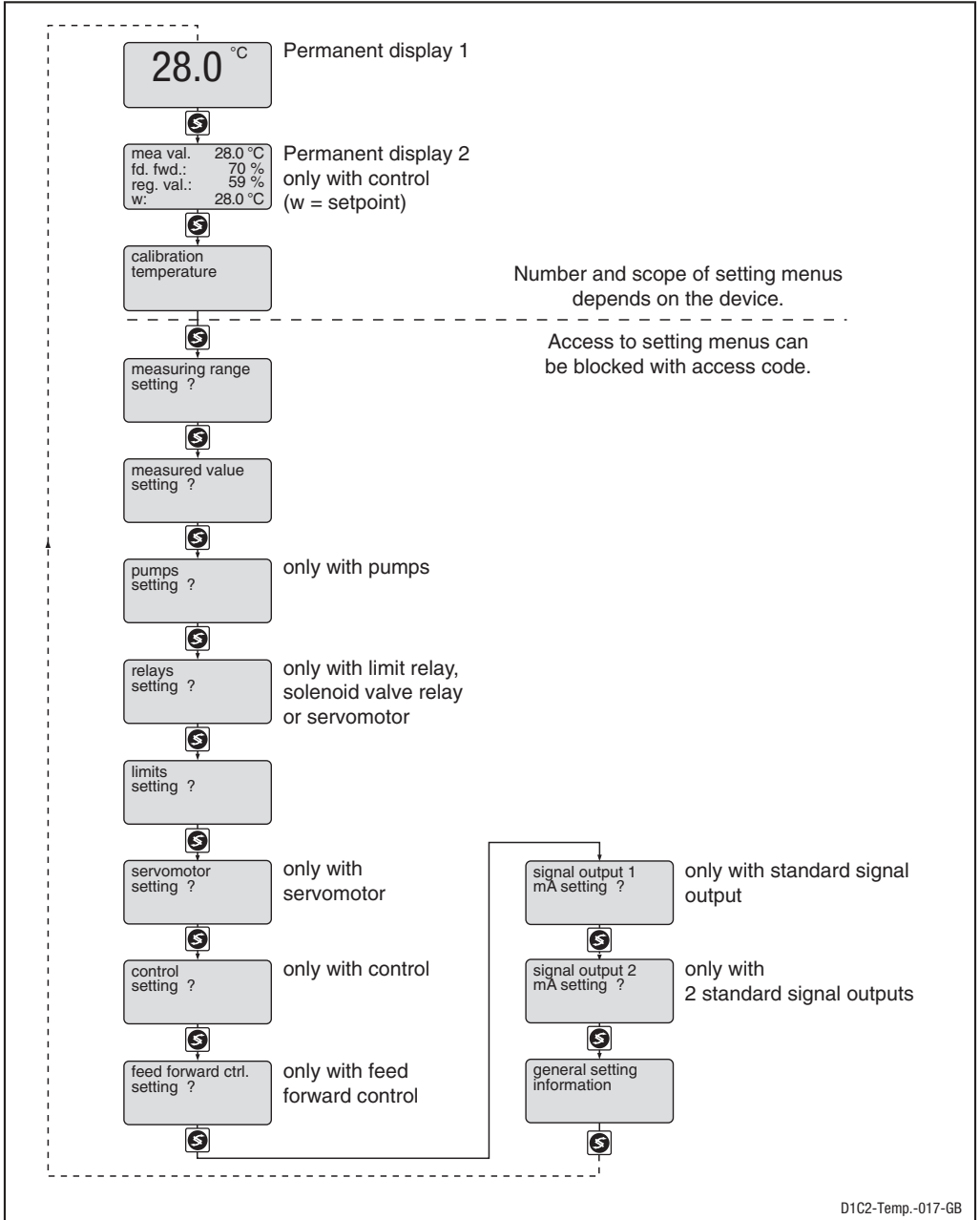

Complete Operating Menu / Description

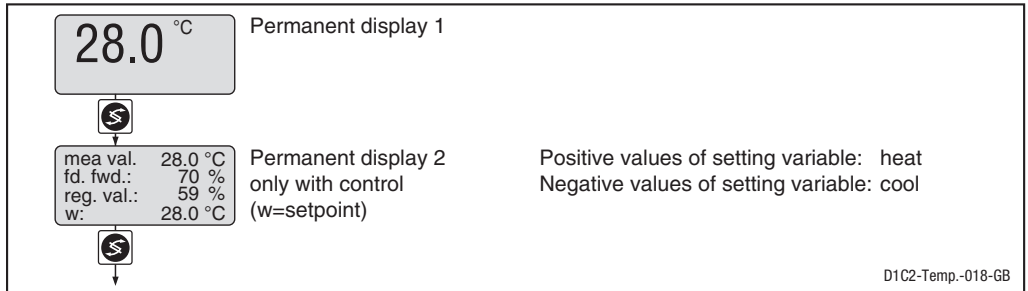

Calibrating the Pt 100 (two-point calibration)

During calibration, metering is reduced to the set basic load. The standard signal of the output (measured value) is reduced to 0 mA or 4 mA. As value the measured value is proposed; this value is adjustable.

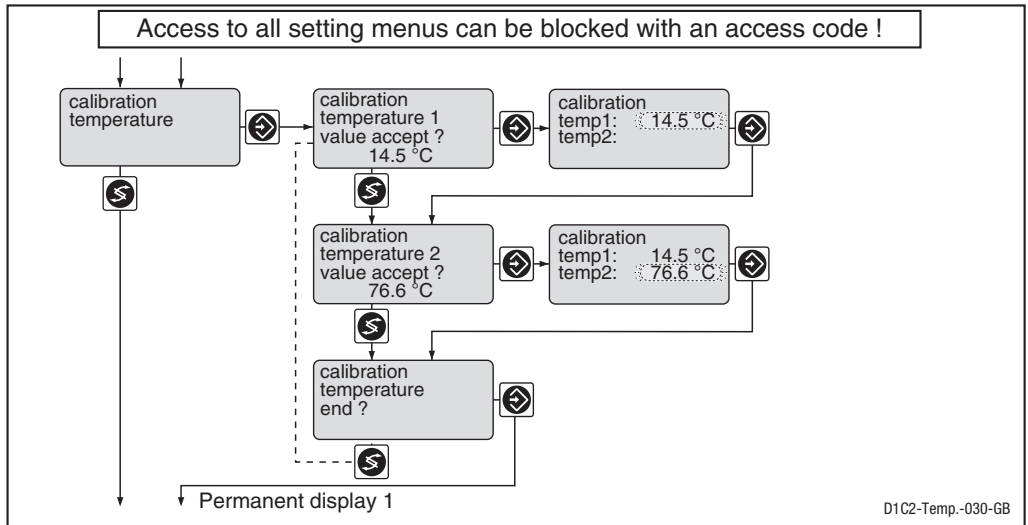

	Initial value	Possible values			Remarks
		Increment	Lower value	Upper value	
	Measured value	0.1 °C 0.1 °F	-5 °C 23 °F	105 °C 221 °F	

Error message	Condition	Effect
Temperatur distance too small	Δ temperature > 5.0 °C Δ temperature > 9.0 °F	Measured value deleted Repeat calibration of measuring point

Complete Operating Menu / Description

Measured variable

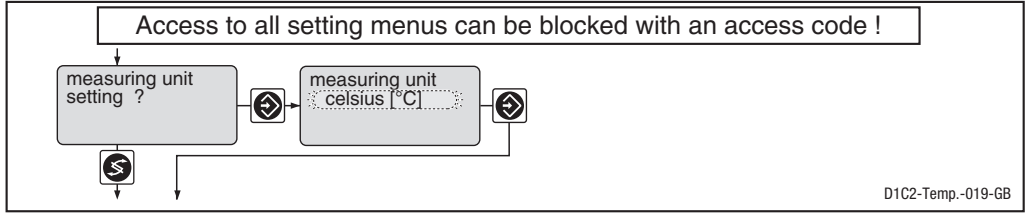

IMPORTANT

When changing the measuring unit adjustment, the adjustments in all menus have to be checked!

	Initial value	Possible values			Remarks
		Increment	Lower value	Upper value	
Measuring unit	Celsius (°C)	Celsius (°C) Fahrenheit (°F)			

Measured value

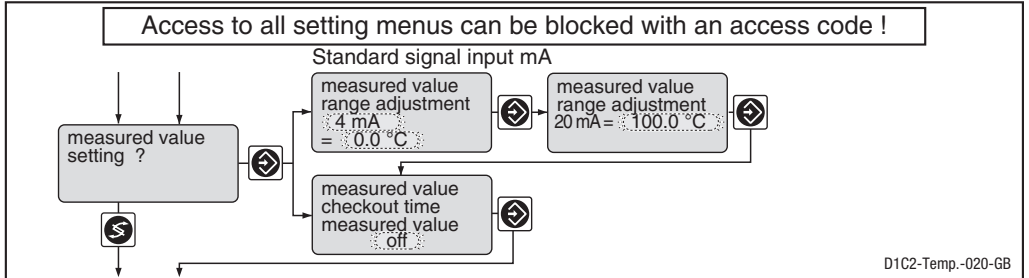

IMPORTANT

When changing the range adjustment, the temperature sensor must be newly calibrated and the adjustments in all menus have to be checked!

	Initial value	Possible values			Remarks
		Increment	Lower value	Upper value	
Standard signal input lower signal limit	4 mA	0 mA 4 mA			
Allocated measuring range upper	0-100 °C 32-212 °F	0.1 °C 0.1 °F	-5 °C 23 °F	105 °C 221 °F	
Checkout time	off	1 s	1 s	9999 s	Constant measurement signal results in message and alarm. Function off = 0 s

Complete Operating Menu / Description

Measured value checkout time



IMPORTANT

This function may not be activated for applications in which it can be assumed that the measured value will not change.

This function tests whether the measured value changes from that of the sensor (at the measured value input) within the “Measured value checkout time”. It is assumed that it will do so for an intact sensor. If the measuring value does not change during this checkout time, the DULCOMETER® D1C sets the control variable to “0” and the alarm relay drops out. The LCD display shows e.g. the message “check Te-sensor”.

Pumps

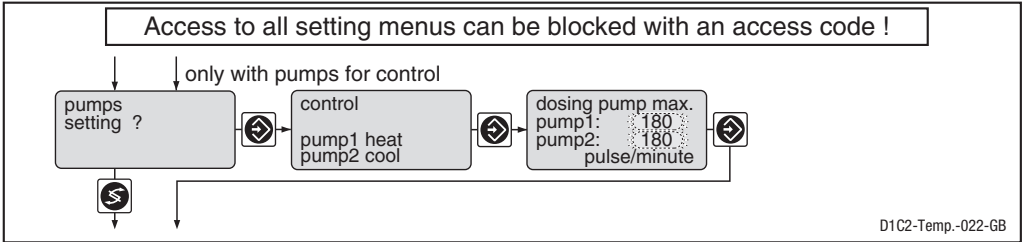

	Initial value	Possible values			Remarks
		Increment	Lower value	Upper value	
Max. stroke/minute of pumps 1 and 2	180	1	1	500	off = 0 stroke/min

Relay for power control

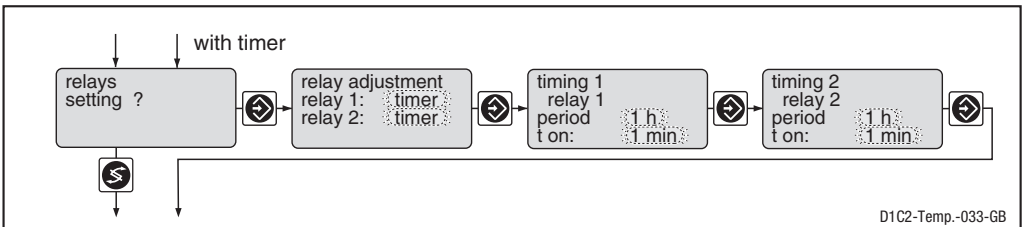
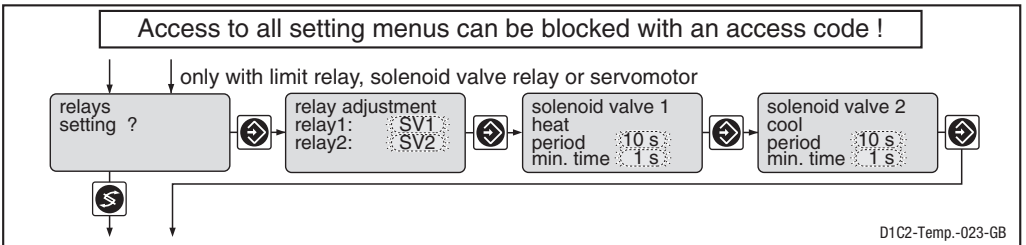

Complete Operating Menu / Description

	Initial value	Possible values			Remarks
		Increment	Lower value	Upper value	
Relay adjustment	as per identity code				
Relay 1		Solenoid valve 1 Limit value 1* Actuator 1 Timer 1 Servomotor off			* In the case of "Limit value" - relays remain active even in the event of an error. only with servomotor
Relay 2		Solenoid valve 2 Limit value 2* Actuator 2 Timer 2 off			
Period	10 s	1 s	10 s	9999 s	for solenoid valve
min. time	1 s	1 s	1 s	period/2	for solenoid valve Set here the smallest permitted operating factor of the connected device.
Period	off	1 h	1 h/off	240 h	for timer
t on	1 min	1 min	1 min	60 min	for timer

NOTE

The limit value relay can be defined in such a way as to respond as a control element, i.e. if a limit value relay closes a circuit, it opens when a pause contact is activated and/or for a subsequent delay period t_d (if t_d is set to > 0 min in "General settings").

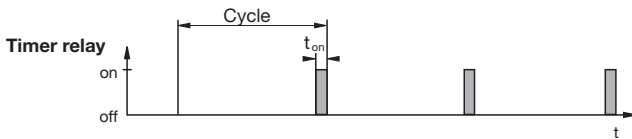

IMPORTANT

The timer will reset in the event of a power failure.

At the end of the (timer) cycle time the DULCOMETER® D1C closes the assigned relay for the duration of "t on" (timer). "Pause" interrupts the timer.

When the clock is shown in the LC display the timer can be reset to the start of the cycle at precisely this point using the enter button.

The % figure in the LC display indicates the progress of the current cycle.

Timer relays may be used, e.g. for shock metering or sensor cleaning.

Complete Operating Menu / Description

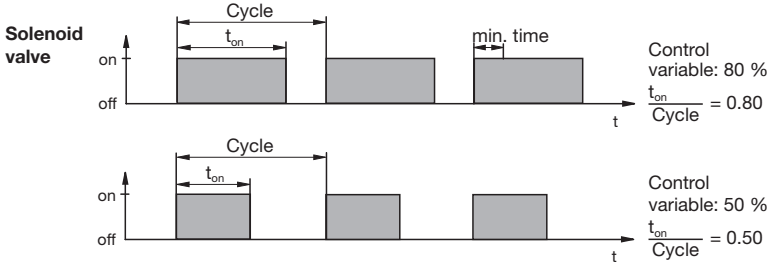

The switching time of the DULCOMETER® D1C (solenoid valve) depends on the control variable and the “min. time” (smallest permitted operating factor of the connected device). The control variable determines the ratio $t_{on}/cycle$ and thus the switching times (see fig. above). The “min. time” influences the switching times in two situations:

a) theoretical switching time < min. time:

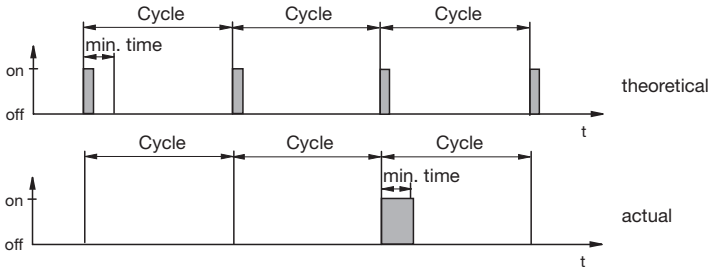

The DULCOMETER® D1C does not switch for a certain number of cycles until the sum of the theoretical switching times exceeds the “min. time”. Then the DULCOMETER® D1C switches for the duration of this total time.

b) theoretical switching time > (cycle - min. time) and calculated switching time < cycle

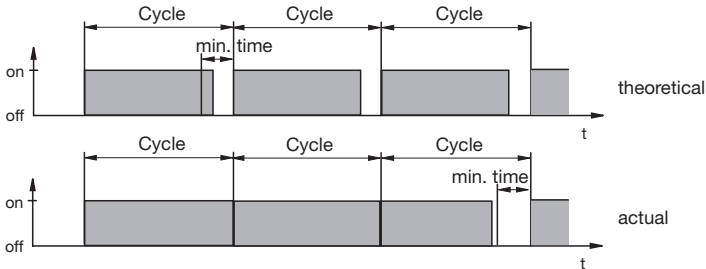

The DULCOMETER® D1C does not deactivate for a certain number of cycles until the differences between cycle and theoretical switching time exceeds the “min. time”.

Complete Operating Menu / Description

Limit values

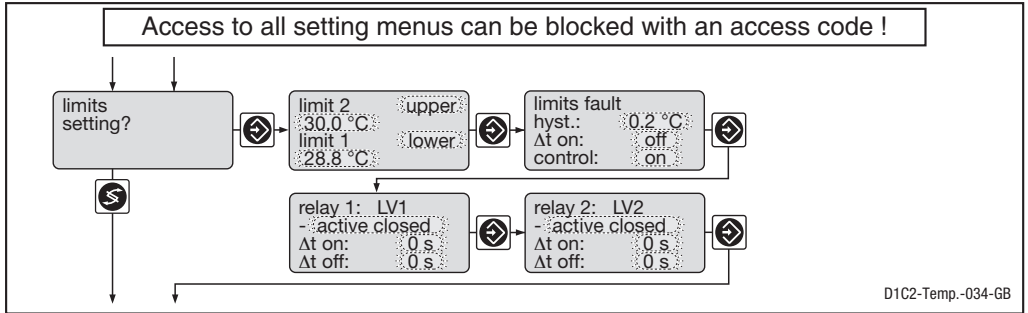

	Initial value	Possible values			Remarks
		Increment	Lower value	Upper value	
Type of limit transgression	Limit 1: lower Limit 2: upper	upper lower off*			Limit transgression when exceeding or dropping below value *only with limit value relay Measuring unit °Celsius
Limit value	Limit 1: 28.0 °C Limit 2: 30.0 °C	0.1 °C 0.1 °C	-5 °C -5 °C	105 °C 105 °C	
Limit value	Limit 1: 78.8 °F Limit 2: 86 °F	0.1 °F 0.1 °F	23 °F 23 °F	221 °F 221 °F	Measuring unit °Fahrenheit
Hysteresis limits	0.2 °C 0.4 °F	0.1 °C 0.1 °F	0 °C 0 °F	105 °C 221 °F	Effective in direction of cancelling limit transgression.
Checkout time limits Δt on	off	1 s	1 s	9999 s	Results in message and alarm. off = 1 s: Function switched off, no message, no alarm
Control	on	on off			
Switching direction					
Limit value 1	active closed	active closed			Acts as N/O
Limit value 2		active open			Acts as N/C
Switch-on delay Δt on	0 s	1 s	0 s	9999 s	
Switch-off delay Δt off	0 s	1 s	0 s	9999 s	

Complete Operating Menu / Description

Servomotor

The **operating range** is defined by the total resistance range of the feedback potentiometer. The maximum limit of the range actually used is set by defining the **control range**.



IMPORTANT

- To ensure correct operation, the activation time of the servomotor used should not be less than 25 seconds for the control range from 0...100 %!
- Activation of the servomotor must be carried out with the same meticulous care as taken when calibrating a measuring sensor.

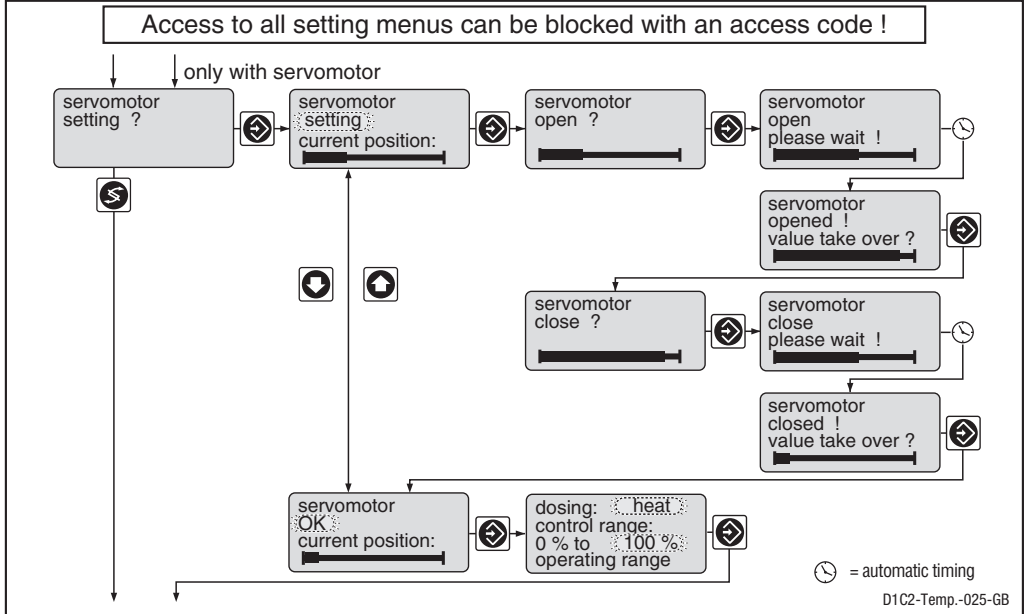

	Initial value	Possible values			Remarks
		Increment	Lower value	Upper value	
Servomotor	setting	setting ok off			
Control direction	heat	heat cool			
Control range	100 %	1 %	10 %	100 %	in % of operating range

NOTE

- When the wide bar is as right as it will go, the stroke adjustment motor is fully open.
- The permanent display shows to what degree the motor has opened in % (the greater the percentage, the farther open the servomotor.)

Complete Operating Menu / Description

Control

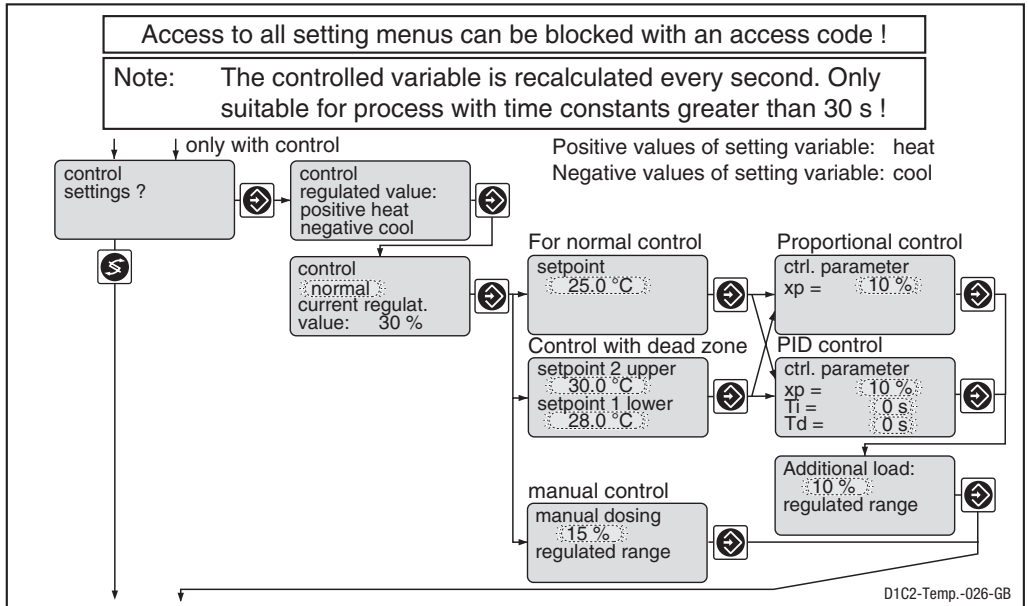

	Initial value	Possible values			Remarks
		Increment	Lower value	Upper value	
Control	normal	normal with dead zone manual			When controlling with dead zone, the feed forward control is not used for measured values within the dead zone.
Setpoint	28 °C 82,4 °F	0.1 °C 0.1 °F	-5 °C 23 °F	105 °C 221 °F	2 setpoints necessary for control with dead zone. Setpoint 1 > setpoint 2
Control parameter xp	10 %	1 %	1 %	500 %	xp referred to measuring range
Control parameter Ti	off	1 s	1 s	9999 s	Function off = 0 s
Control parameter Td	off	1 s	1 s	2500 s	Function off = 0 s
Additive basic load	0 %	1 %	-100 %	+100 %	
Manual metering	0 %	1 %	-100 %	+100 %	

Abbreviation for control variables:

x_p = 100 %/Kp (inverse proportional coefficient)

T_i = I controller integration time [s]

T_d = D controller differential time [s]

Complete Operating Menu / Description

Feed forward control

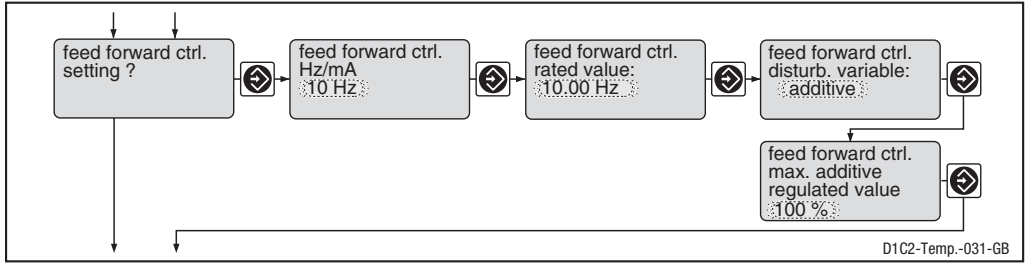

	Initial value	Possible values			Remarks
		Increment	Lower value	Upper value	
Feed forward control (Flow)	as per identity code at standard signal: 4–20 mA	None 10 Hz 500 Hz 0...20 mA 4...20 mA			Signal processing: Signal <0,02 Hz = No flow Signal <0,2 Hz = No flow Signal <0,2 mA = No flow Signal <4,2 mA = No flow
Feed forward control rated value	10 Hz 500 Hz 20 mA	0.01 Hz 1 Hz 0.1 mA	0.1 Hz 5 Hz 0/4 mA	10 Hz 500 Hz 20 mA	Depends on signal type. Maximum limitation of range used.
Feed forward control Disturbance effect	multiplicative	multiplicative			
Max. additive regulated variable	100 %	1 %	-500 %	+500 %	Only with additive feed forward control.

Standard signal output 1

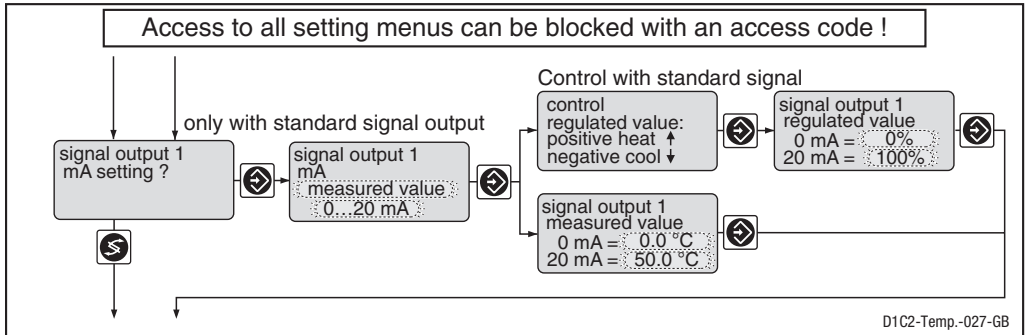

Complete Operating Menu / Description

Standard signal output 2

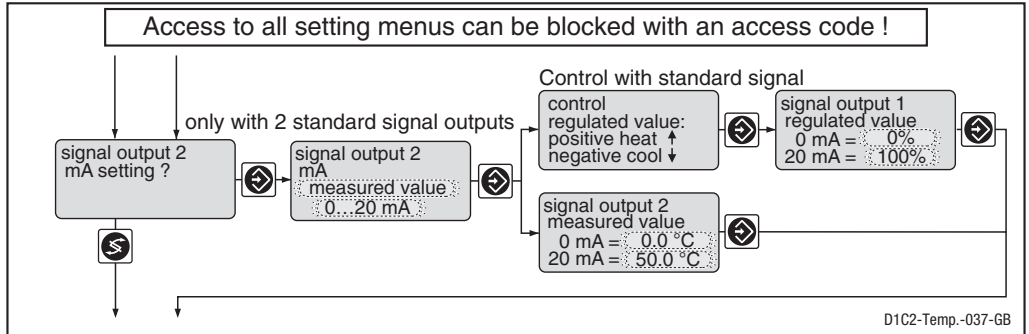

	Initial value	Possible values			Remarks
		Increment	Lower value	Upper value	
Variable allocation	as per identity code	Measured value Regulated variable			If control applicable
Output range	0...20 mA	0...20 mA 4...20 mA 3.6/4-20 mA			
Range measured value	0-50 °C 32-122 °F	0.1 °C 0.1 °F	-5 °C 23 °F	105 °C 221 °F	Reduction to 3.6 mA when alarm relay switches (not limit value violation)
Range controlled variable	0%...+100 %	1 %	-100 %	+100 %	Minimum range 0.1 % of measured value Minimum range 1 %

General setting

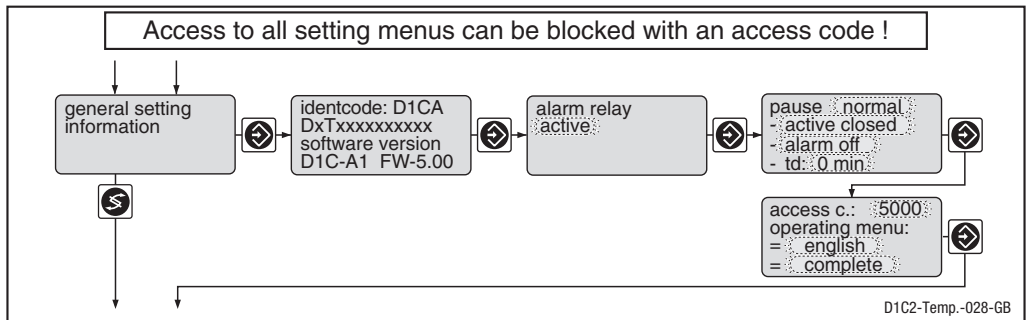

Complete Operating Menu / Description

	Initial value	Possible values		Upper value	Remarks
		Increment	Lower value		
Alarm relay	active	active not active			Acts as N/O Acts as N/C Alarm relay can be activated through pause contact.
Pause	normal	normal hold			
Control input pause	active closed	active closed active open			
Alarm Pause	alarm off	alarm off alarm on			
td	0 min	1 min	0 min	60 min	
Access code	5000	1	1	9999	
Language	as per identity code	as per identity code			
Operating menu	complete	restricted complete			

Normal pause

If the pause switch is off, the DULCOMETER® D1C sets the operating outputs to “0” for as long as the pause switch is off or for a set time delay t_d (if t_d is set to > 0 min). Whilst the pause switch is off, the D1C establishes the P-proportion in the background.

With PID-control (identity code characteristics “control characteristic” = 2): the I-proportion is stored when the pause is switched off (I-proportion then usually only present if $Ti > 0$ has been selected in the “Control setting?” setting menu).

Exception: the standard signal outputs mA for the measured value or correction value are not affected by the pause.

After pause is activated, the operating outputs remain at “0” for the length of the time delay t_d . The time delay t_d must be set up in such a way that in this time e.g. sample water (process-specific current concentration) flows to the sensor.

With PID-control (identity code characteristics “control characteristic” = 2): The control variable output resulting from the pause and the expiry of the time delay t_d is reconciled jointly with the current P-component and (if Ti is set > 0) with the stored I-component.

Pause hold

If the pause switch is off, the DULCOMETER® D1C freezes the operating output at the most recent value for as long as the pause switch is off or for a set time delay t_d (if t_d is set to > 0 min). Whilst the pause switch is off, the D1C establishes the P-proportion in the background.

With PID-control (identity code characteristics “control characteristic” = 2):

Even the mA standard signal outputs for measured value or correction value are frozen.

After pause is activated, the operating outputs remain frozen for the length of the time delay t_d . The time delay t_d must be set up in such a way that in this time e.g. sample water (process-specific current concentration) flows to the sensor.

With PID-control (identity code characteristics “control characteristic” = 2): The control variable output resulting from the pause and the expiry of the time delay t_d is reconciled jointly with the current P-proportion and (if Ti is set > 0) with the newly established I-proportion.

Access Code

Access to the setting menu can be prevented by setting up an access code. The DULCOMETER® D1C controller is supplied with the access code 5000 which permits free access to the setting menu. The calibration menu remains freely accessible even when access to the setting menu is blocked by the code.

9 Faults / Notes / Troubleshooting

Fault	Fault text	Symbol	Effect On metering	Effect On Control	Alarm with acknowledgement	Remarks	Remedy
Measured variable exceeded Checkout time measured value exceeded	<i>Check Te-sensor</i>	☒	Basic load	Stop	Yes	Function detachable	Check function of sensor
Signal exceeded/drops below value	<i>Temp. Input ↕</i>	☒	Basic load	Stop	Yes	Signal < 3.8 ±0.2mA or >23 ±0.2 mA	Check sensor, transducer and cable connection
Feed forward control mA - Signal drops below value multiplicative additive	<i>feedfwd input <4 mA</i>	☒	stops continue continue	continue continue continue	Yes	Signal < 3.8 mA ±0.2 mA or >23 ±0.2 mA Value last valid is used	Check sensor, transducer and cable connection
- Signal exceeded	<i>feedfwd input >23 mA</i>	☒	continue	continue	Yes	Function detachable	Define cause, reset values if necessary
Limit transgression after checkout time limit values Control "on" Control "off"	<i>Te -limit 1 Te -limit 2</i>	☒ ☒	Stop or Basic load	Stop	Yes Yes		
Servomotor Position not reached	<i>Servomot. defect.</i>	☒			Yes	Servomotor closes	Check servomotor
Electronics error	<i>System defect.</i>	☒	Stop	Stop	Yes	Electronic data defective	Call in service

Operation	Note text	Symbol	Effect		Alarm with acknowledgement	Remarks	Remedy
			on metering	on control			
Pause contact	<i>Pause</i>	☒	Stop	Stop	No/Yes*	No further fault check	-
	<i>Pause/Hold</i>	☒		PI-compo- nent frozen			
Stop button	<i>Stop</i>	☒	Stop	Stop	No	Relay drops out	-
During servomotor setting Position feed back wrong Upper position <40 % max. value Lower position >30 % range	<i>Direction check Final value too small/ Final value too big</i>	☒				Without correct adjustment the last valid values are still used	Check connection of relay and potentiometer. Adjust the operation range of the servomotor correctly.

*depending on whether "Alarm on" or "Alarm off" set in "General settings"