

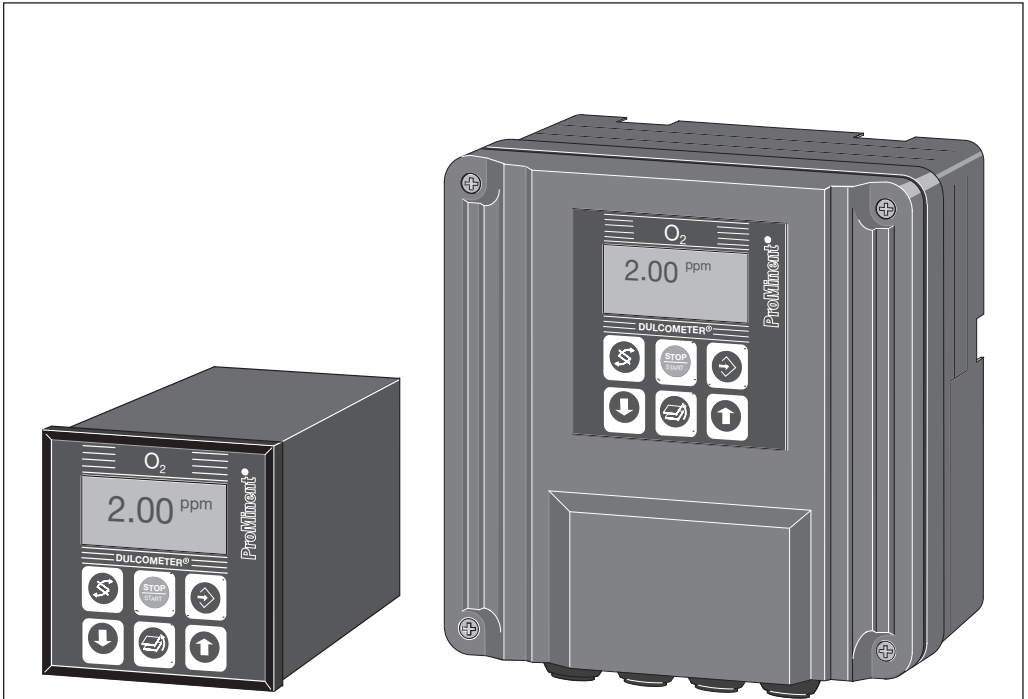

Operating Instructions

DULCOMETER® D1C

Part 2: Adjustment and Operation,
Measured Variable Oxygen



Type D

Type W

D1C A _____

Please enter the identity code of your device here!

**Please completely read through operating instructions! · Do not discard!
The operator shall be liable for any damages caused
by installation or operating errors.**

1 Device Identification / Identity Code

D1C A	DULCOMETER® Controller Series D1C / Version A
	Type of mounting
D	Control panel installation 96 x 96 mm
W	Wall mounting
	Operating voltage
0	230 V 50/60 Hz
1	115 V 50/60 Hz
2	200 V 50/60 Hz (only with control panel installation)
3	100 V 50/60 Hz (only with control panel installation)
4	24 V AC/DC
	Measured variable
X	Oxygen
	Connection of measured variable
1	Terminal, standard signal 0/4–20 mA
	Correction variable
0	None
	Feed forward control
0	None
1	As standard signal 0/4-20 mA
2	As frequency 0-500 Hz
3	As frequency 0-10 Hz
	Control input
0	None
1	Pause
	Signal output
0	None
1	standard signal 0/4-20 mA measured value
2	standard signal 0/4-20 mA control variable
4	2 standard signal 0/4-20 mA outputs, free programmable
	Power control
G	Alarm and 2 limit value/timer relays
M	Alarm and 2 solenoid valve relays
R	Alarm relay and servomotor with feedback
	Pump control
0	None
2	Two pumps
	Control characteristic
0	None
1	Proportional control
2	PID control
	Log output
0	None
	Language
D	German
E	English
F	French
I	Italian
N	Dutch
S	Spanish
P	Polish
A	Swedish
G	Czech
H	Hungarian

D1C A _ _ _ _ _ _ _ _ _ _ _ _ _ _ _ _ _ _ _ _ _ _

Please enter the identity code of your device here!

2 General User Information

	Page
1 Device Identification / Identity Code	2
2 General User Information	3
3 Device Overview / Controls	4
4 Functional Description	5
5 Display Symbols	6
6 Operation	7
7 Restricted Operating Menu	8
Layout	8
Description	9
8 Complete Operating Menu	12
Overview	12
Description	13
9 Fault / Remarks / Troubleshooting	27

General User Information

These operating instructions describe the technical data and function of DULCOMETER® D1C controller, provide detailed safety information and are divided into clear steps.



IMPORTANT

- ***Please observe the parts of these operating instructions applicable to your particular version! This is indicated in the Section “Device Identification / Identity Code”!***
- ***Correct measuring and dosing is only possible in the case of impeccable operation of the probe. The probe has to be calibrated / checked regularly!***

NOTE

A form “Documentation of controller settings Type D1C” is available under www.prominent.com/documentation_D1C for the purpose of documenting the controller settings.

3 Device Overview / Controls

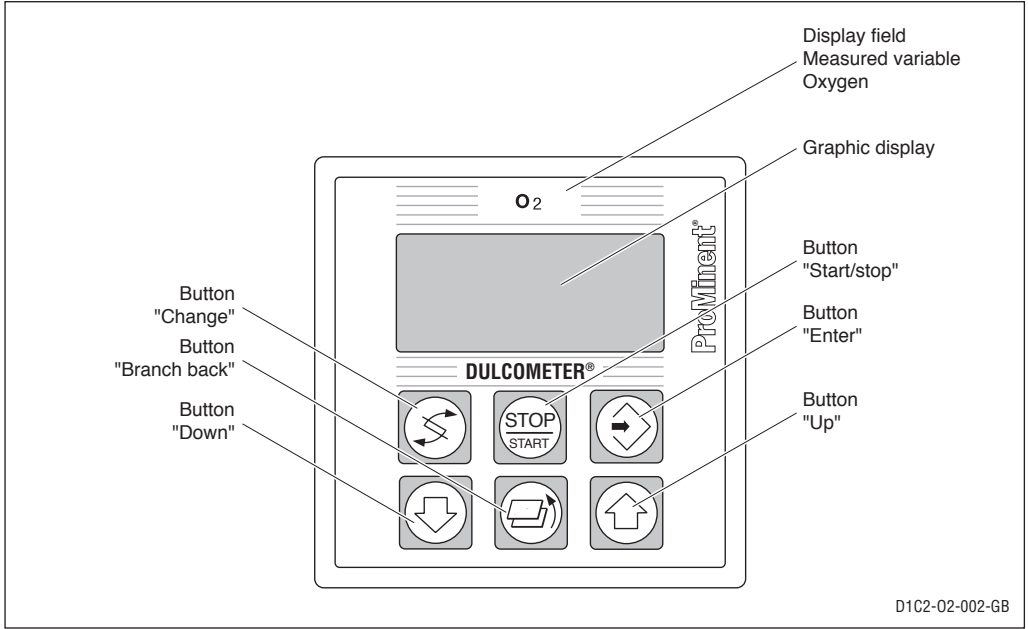

D1C2-02-002-GB

	<p>CHANGE button</p> <p>To change over within a menu level and to change from one variable to another within a menu point.</p>
	<p>START/STOP button</p> <p>Start/stop of control and metering function.</p>
	<p>ENTER button</p> <p>To accept, confirm or save a displayed value or status. For alarm acknowledgement.</p>

	<p>UP button</p> <p>To increase a displayed numerical value and to change variables (flashing display)</p>
	<p>BRANCH BACK button</p> <p>Back to permanent display or to start of relevant setting menu.</p>
	<p>DOWN button</p> <p>To decrease a displayed numerical value and to change variables (flashing display).</p>

4 Functional Description

NOTE

Please refer to the description of the complete operating menu in chapter 8 for a detailed description of the individual characteristics of the DULCOMETER® D1C controller!

4.1 Operating Menu

The DULCOMETER® D1C controller permits settings to be made in two different menus. All values are preset and can be changed in the **complete operating menu**.

The controller is delivered with a **restricted operating menu** so that the D1C controller can be used effectively in many applications from the very onset. If adaptations prove to be necessary, all relevant parameters can then be accessed by switching over to the complete operating menu (see "General settings").

4.2 Access Code

Access to the setting menu can be prevented by setting up an access code. The DULCOMETER® D1C controller is supplied with the access code 5000 which permits free access to the setting menu. The calibration menu remains freely accessible even when access to the setting menu is blocked by the code.

4.3 Control

The D1C can operate as a proportional controller or as a PID controller - dependent on the device version (see identity code) and the setting.

The controlled variable is recalculated once a second. Control procedures which require rapid correction of setpoint deviations (less than approx. 30 seconds) cannot be processed with this controller. The cycle times must be taken into consideration when activating solenoid valves (pulse length) in the same way as their running times when activating servomotors (3-point).

Via the control input pause, the control function (selection of controlled variable) can be switched off. The calculation of the controlled variable starts again after cessation of "pause".

4.4 Feed Forward Control

The D1C controller can process a signal of a feed forward control. Depending on the device version (see identity code) and the setting, this signal can be obtained in any form of a 0–20 mA or 4–20 mA signal or as a digital contact signal with the maximum frequencies 10 Hz or 500 Hz.

This signal can be used, for example, for flow-proportional metering (multiplicative effect) or feed forward-dependent basic load metering (additive effect). The result of control variable calculation from the proportional or PID control is multiplied by or added to the feed forward signal. A multiplicative feed forward variable at the level of the set rated value carries over the calculated control variable unchanged into the controlled variable:

$$\text{Controlled variable} = \text{Feed forward variable} / \text{rated value} \times \text{calculated control variable}$$

During start-up, the zero point has to be checked. The multiplicative feed forward control is not designed for switching off permanently the actuating variable (signal \approx 0).

An additive feed forward variable at the level of the rated value results in maximum controlled variable:























$$\text{Controlled variable (max. 100 \%)} = \text{Feed forward variable} / \text{rated value} \times \text{max. controlled variable} + \text{calculated control variable.}$$

4.5 Error Messages

Error messages and information are indicated on the bottom line in the permanent display 1. Errors to be acknowledged (acknowledgement switches off the alarm relay) are indicated by the "E". Errors/notes which still apply after acknowledgement are indicated alternately. During correction variable processing (temperature for correction of pH-value), the value is indicated in the same line as the error/note. Faults which are rectified of their own accord due to changed operating situations are removed from the permanent display without the need for acknowledgement.

5 Display Symbols

The display of the DULCOMETER® D1C controller uses the following symbols:

Description	Comment	Symbol
Limit value transgression Relay 1, upper	Symbol left	
Relay 1, lower	Symbol left	
Relay 2, upper	Symbol right	
Relay 2, lower	Symbol right	
Metering pump 1 (Oxygen) Control off	Symbol left	
Control on	Symbol left	
Metering pump 2 (De-O ₂) Control off	Symbol right	
Control on	Symbol right	
Solenoid valve 1 (Oxygen) Control off	Symbol left	
Control on	Symbol left	
Solenoid valve 2 (De-O ₂) Control off	Symbol right	
Control on	Symbol right	
Servomotor Control, open relay		 
Control, close relay		 
Without control		 
Position feedback	The bar increases from left to right during opening.	
Stop button pressed		
Manual metering		
Fault		

6 Operation

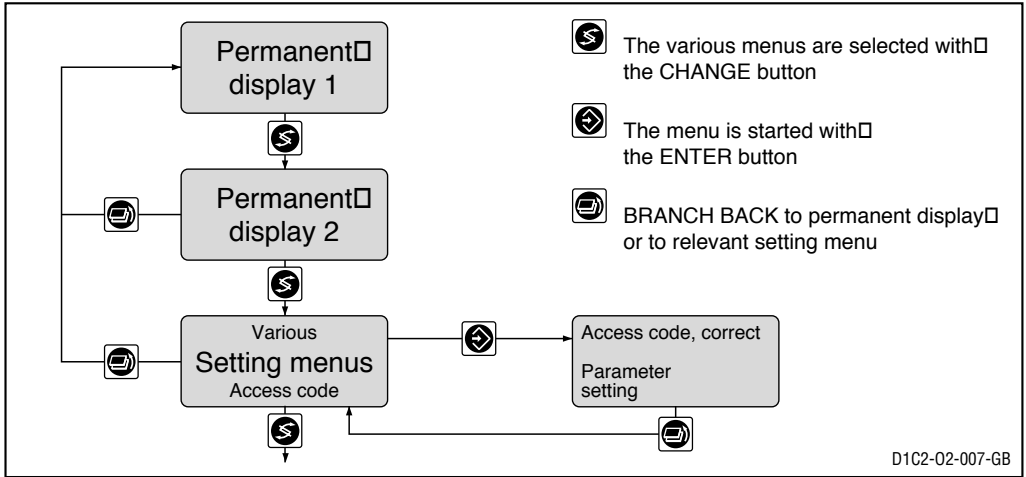

NOTE

Access to the setting menu can be barred with the access code!

The number and scope of setting menu is dependent on the device version!

If the access code is selected correctly in a setting menu, then the following setting menus are also accessible!

If within a period of 10 minutes no button is pushed, the unit automatically branches back from the calibrating menu or a setting menu to the permanent display 1.

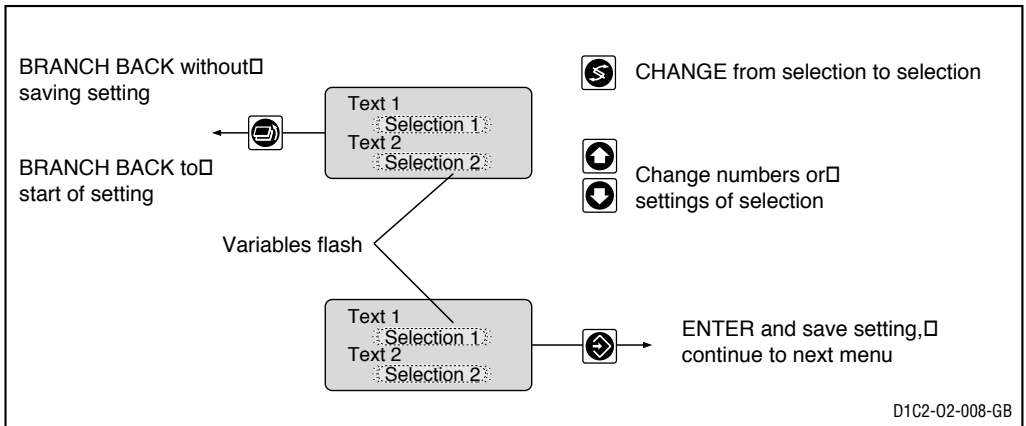

7 Restricted Operating Menu / Layout

The restricted operating menu permits simple operation of the most important parameters. The following overview shows the settings which can be selected:

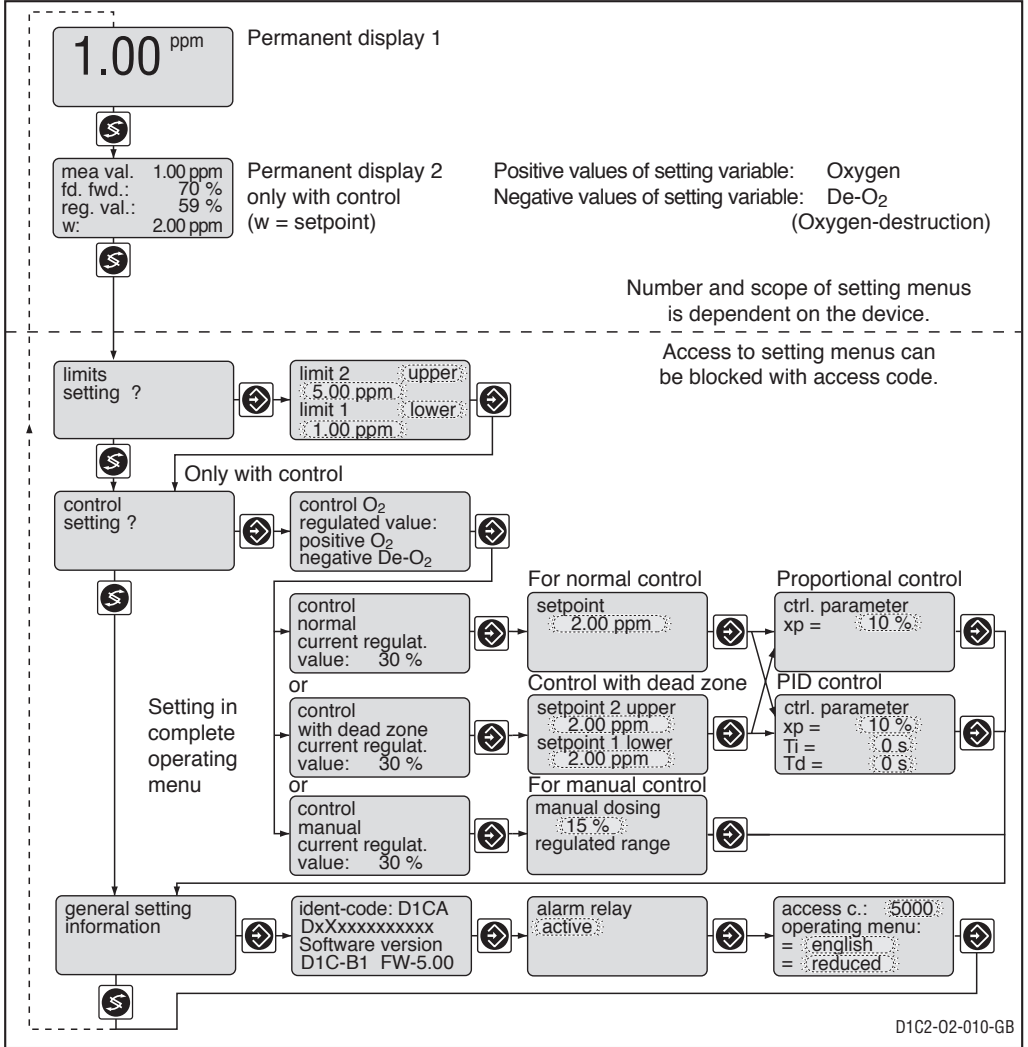

Restricted Operating Menu / Description

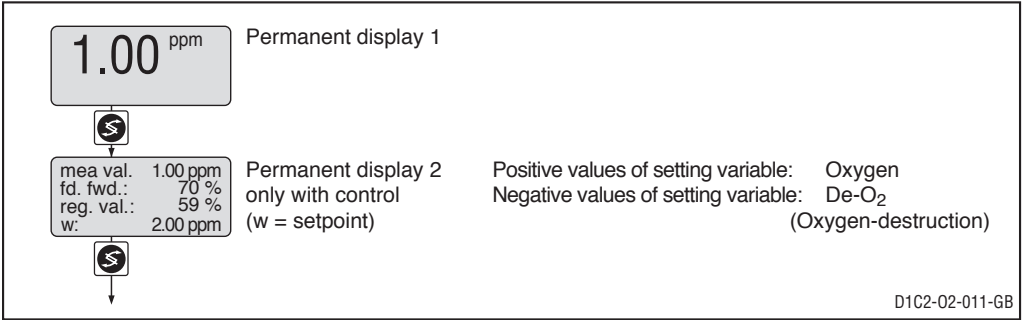

Limits

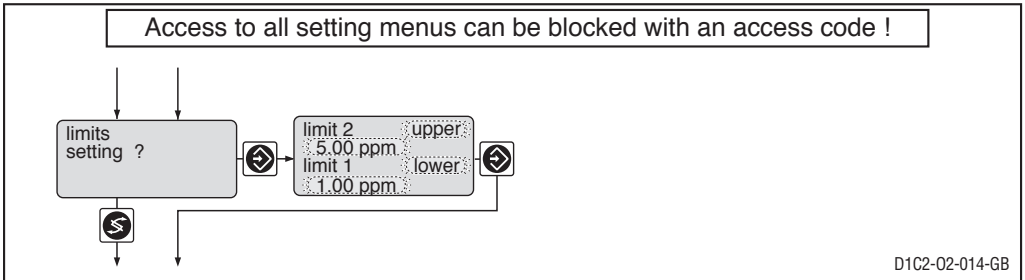

		Initial value	Possible Values			Remarks
			Increment	Lower value	Upper value	
Type of limit Transgression	Limit 1:	lower	upper			Limit transgression when exceeding or dropping below value *see "measuring range setting" (complete operating menu)
	Limit 2:	upper	off*			
Limit value	Limit 1	1.00 ppm	0.01 ppm	-1.00 ppm	11.00 ppm	
	Limit 2	5.00 ppm	0.01 ppm	-1.00 ppm	11.00 ppm	
	Limit 1	2.00 ppm	0.01 ppm	-2.00 ppm	22.00 ppm	
	Limit 2	10.00 ppm	0.01 ppm	-2.00 ppm	22.00 ppm	
	Limit 1	5.00 ppm	0.01 ppm	-5.00 ppm	55.00 ppm	
	Limit 2	25.00 ppm	0.01 ppm	-5.00 ppm	55.00 ppm	
	Limit 1	70.0 %	0.1 %	-10.0 %	110.0 %	
	Limit 2	90.0 %	0.1 %	-10.0 %	110.0 %	
	Limit 1	140.0 %	0.1 %	-20.0 %	220.0 %	
	Limit 2	180.0 %	0.1 %	-20.0 %	220.0 %	
	Limit 1	350.0 %	0.1 %	-50.0 %	550.0 %	
	Limit 2	450.0 %	0.1 %	-50.0 %	550.0 %	

Restricted Operating Menu / Description

Control

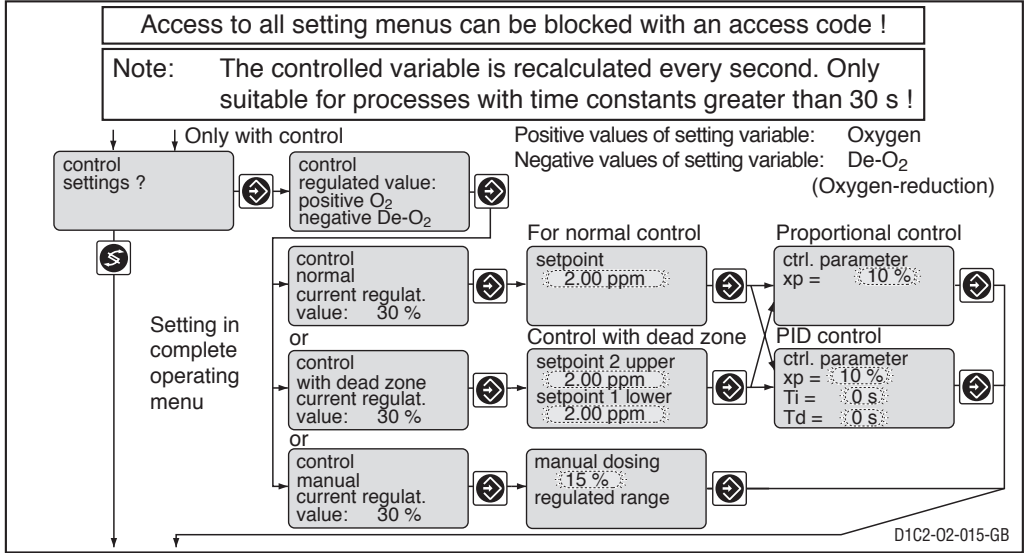

	Possible Values				Remarks
	Initial value	Increment	Lower value	Upper value	
Setpoint	2.00 ppm	0.01 ppm	-0.50 ppm	10.50 ppm	see adjustments of measuring range (Complete operating menu)
	4.00 ppm	0.01 ppm	-1.00 ppm	21.00 ppm	
	10.00 ppm	0.01 ppm	-2.50 ppm	52.50 ppm	
	80.0 %	0.1 %	-5.0 %	105.0 %	
	160.0 %	0.1 %	-10.0 %	210.0 %	
Control parameter xp	400.0 %	0.1 %	-25.0 %	525.0 %	xp referred to measuring range
	10 %	1 %	1 %	500 %	
Control parameter Ti	off	1 s	1 s	9999 s	Function off = 0 s
Control parameter Td	off	1 s	1 s	2500 s	Function off = 0 s
Manual metering	0 %	1 %	-100 %	+100 %	

Abbreviations for control variables:

x_p : 100 %/Kp (inverse proportional coefficient)

T_i : Integration time of I-controller [s]

T_d : Differential time of D-controller [s]

Restricted Operating Menu / Description

General Settings

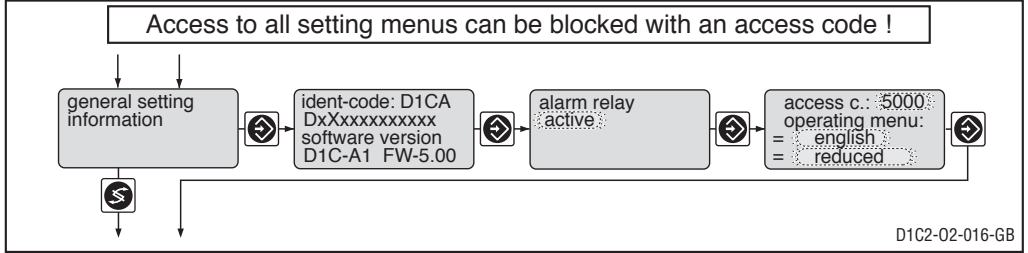

	Initial value	Possible Values		Remarks
		Increment	Lower value	
Alarm relay	active	active not active		
Access code	5000	1	1	9999
Language	as per identity code	as per identity code		
Operating menu	restricted	restricted complete		

Access Code

Access to the setting menu can be prevented by setting up an access code. The DULCOMETER® D1C controller is supplied with the access code 5000 which permits free access to the setting menu. The calibration menu remains freely accessible even when access to the setting menu is blocked by the code.

8 Complete Operating Menu / Overview

All parameters of the controller can be set in the complete operating menu (access see previous page). The following overview shows the settings which can be selected:

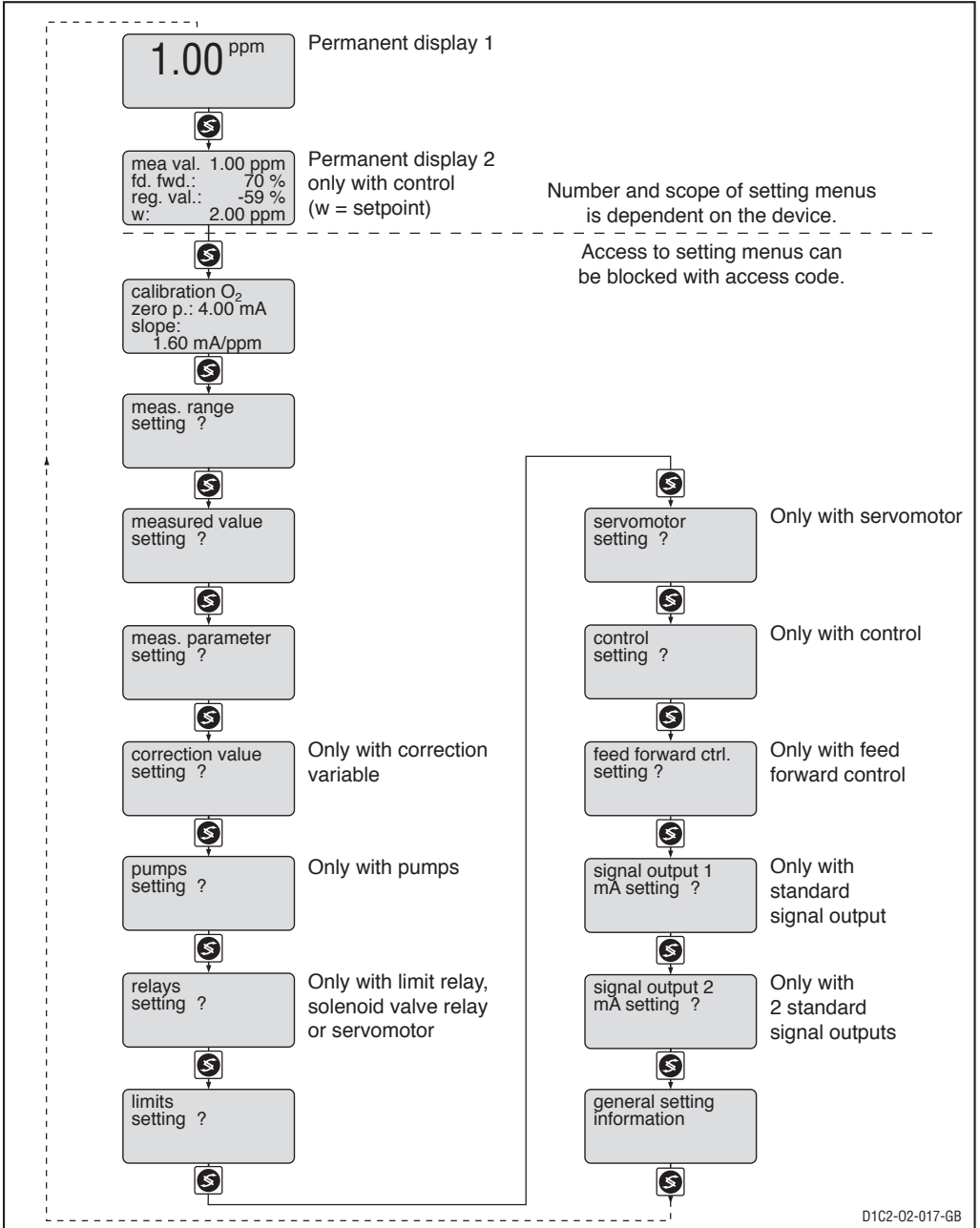

Complete Operating Menu / Description

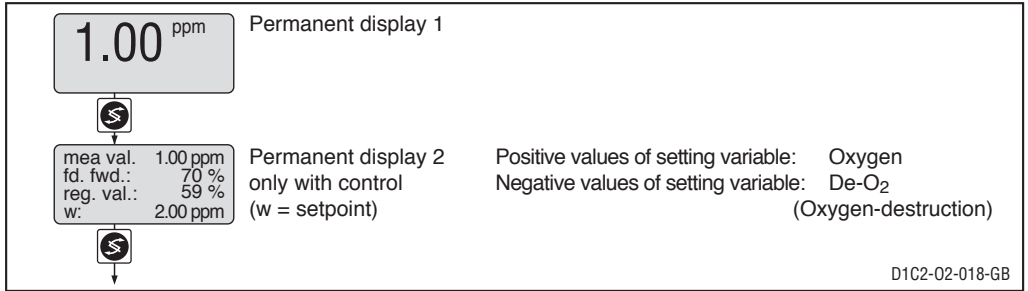

Calibrating the probe for dissolved oxygen

Before the “Calibration O₂, automatic” function can be carried out you need to enter the parameters for correcting the measured value (see complete operating menu, “Measurement parameters”). After carrying out this function, hold the sensor upward for at least 5 min.

The “Calibration O₂”, “O₂ value” function allows you to enter the measured value from a reference value.

The control must be switched off by pressure stop key while calibrating in air (“Calibration O₂, automatic”). The standard signal from the output (measured value) is 4.0 mA.

If calibrating with the aid of a reference value (“Calibration O₂, O₂ value”) the controller function is active. The standard signal from the output (measured value) is unchanged throughout.

Calibration is only possible with this function if the input reference value is $\geq 2\%$ of the measurement range. If calibration is successful, all error investigations relating to the measured value are restarted

Minor stable deviations from the sensor zero point at 4.00 mA can be compensated (go to “Calibration O₂, zero point”, “value take over” and press the Enter button. To reject the value, press the Branch Back button.)



IMPORTANT

The probe measurement range must comply with the set measurement range (factory setting: 0-2 ppm). The measurement range should be reset before calibration (see page 14).

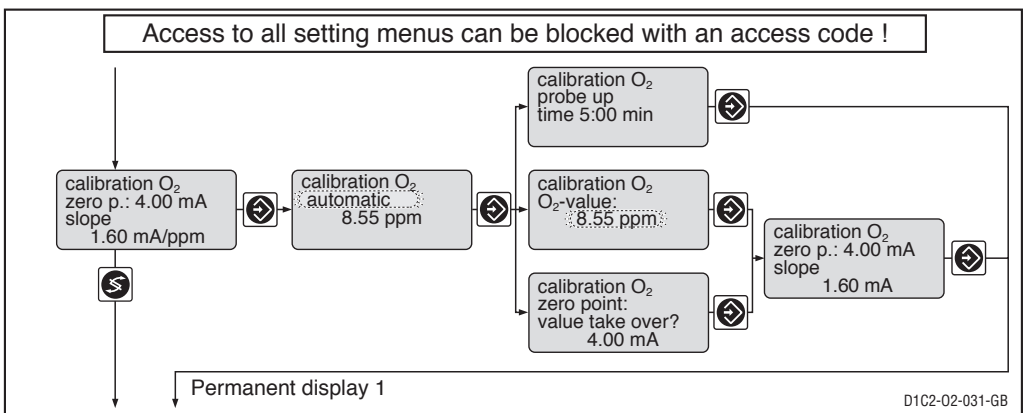

Complete Operating Menu / Description

Measuring Range

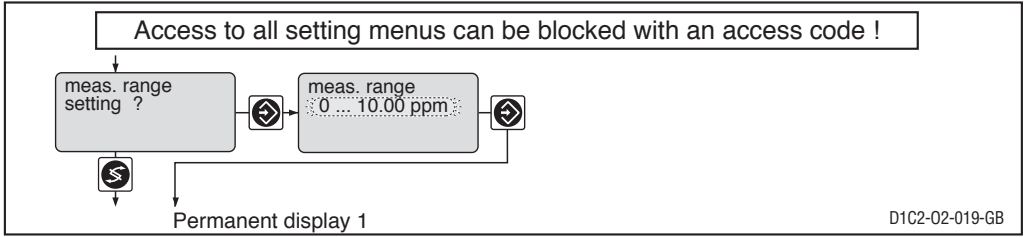

IMPORTANT

When changing the measuring range, setpoints and limit values are switched over to their respective initial values. The settings must be checked in all menus.

	Initial value	Possible Values			Remarks
		Increment	Lower value	Upper value	
Measuring range	0...10.00 ppm	0...10.00 ppm 0...20.00 ppm 0...50.00 ppm 0...100 % 0...200 % 0...500 %			Setpoints and limit values are switched over to their respective initial values.

Measured Value

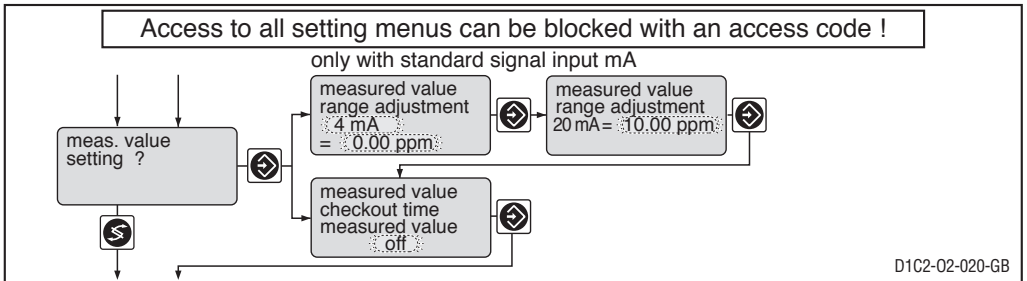

IMPORTANT

When changing the range adjustment, the adjustments in all menus have to be checked!

Measured value control period



IMPORTANT

This function may not be activated for applications in which it can be assumed that the measured value will not change.

This function tests whether the measured value changes from that of the probe (at the measured value input) within the “Measured value control period”. It is assumed that it will do so for an intact probe. If the measured value does not change within this control period the DULCOMETER® D1C sets the control value to “0” and the alarm relay circuit is opened. The LCD displays the message, e.g. “Check O₂ probe”.

Complete Operating Menu / Description

	Initial value	Possible Values			Remarks
		Increment	Lower value	Upper value	
Standard signal input lower signal limit	4 mA	0 mA 4 mA			
Allocated measuring range	0...10.00 ppm 0...20.00 ppm 0...50.00 ppm 0...100 % 0...200 % 0...500 %	0.01 ppm 0.01 ppm 0.01 ppm 0.1 % 0.1 % 0.1 %	-1.00 ppm -2.00 ppm -5.00 ppm -10.0 % -20.0 % -50.0 %	11.00 ppm 22.00 ppm 55.00 ppm 110.0 % 220.0 % 550.0 %	
Checkout time	off	1 s	1 s	9999 s	Constant measurement signal results in message and alarm. Function off = 0 s

Measurement parameters

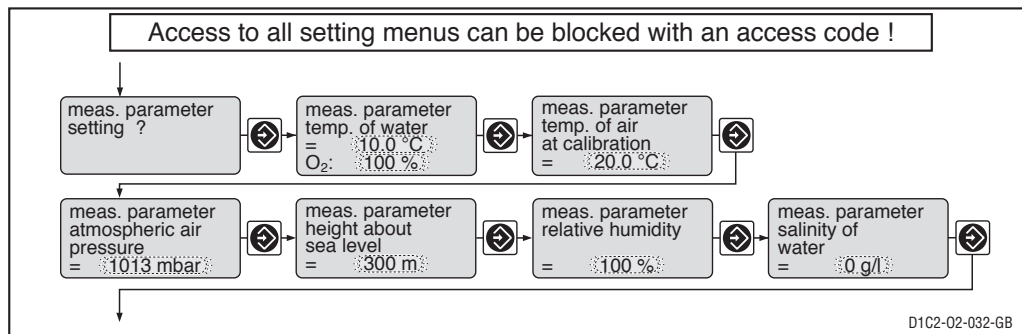

	Initial value	Possible Values			Remarks
		Increment	Lower value	Upper value	
Water temperature	10.0 °C	0.1 °C	0.0 °C	40.0 °C	
Air temperature at calibration	20.0 °C	0.1 °C	0.0 °C	0.0 °C	
Atmospheric air pressure	1013 mbar	1 mbar	300 mbar	1180 mbar	
Height above sea level	300 m	1 m	0 m	9999 m	
Relative humidity	100 %	1 %	0 %	100 %	
Salt content of water	0 g/l	1 g/l	0 g/l	50 g/l	

To retain the prevailing O₂-saturation, enter the actual water temperature in the “meas. parameter, temp. of water” menu option (arrow keys): the DUCLOMETER® D1C immediately calculates the relative O₂-saturation.

Complete Operating Menu / Description

To minimise the effect of the following parameters on the accuracy of the measured O₂-concentration values you can enter their actual values in the “measurement parameters setting?” menu during calibration and in the interim period:

- Local atmospheric pressure at the measuring point related to the height above sea level in mbar
- Height of measurement point above sea level in m
- Relative humidity of the atmosphere at the measuring point in %
- Water temperature in °C
- Air temperature at the measuring point in °C
- Water salt content in g/l

Variation of precision parameters by varying factory settings

Measurement parameter	Factory setting	Deviation	Influence (% of measured value in ppm)
Atmospheric pressure	1013 mbar	10 mbar	around 1 %
Height above sea level	300 m	100 m	around 1 %
Relative humidity	100 %	10 %	around 0.3 %
Salt content of sample water	0 g/l	1 g/l	around 1 %



IMPORTANT

- **At the measurement point measure the atmospheric pressure, the atmospheric humidity pressure, the air and water temperature using normal metering devices.**
- **Determine the actual atmospheric pressure value related to the sea level from an official meteorological station or a reliable homepage (look for height above sea level value) related to a point in the immediate vicinity (do not use a map, too imprecise). This value also to be entered on the pressure gauge.**
- **In high areas the height above sea level must be entered for accurate atmospheric pressure compensation.**
- **Determine the salt content either in the laboratory or by means of continuous conductivity metering using the corresponding conversion.**
- **In order to guarantee obtaining the most accurate possible O₂ values, even between calibration intervals, enter actual values into the DUCLOMETER® D1C if the set values of the maximum stated parameter are very different from the actual values.**

Correction value

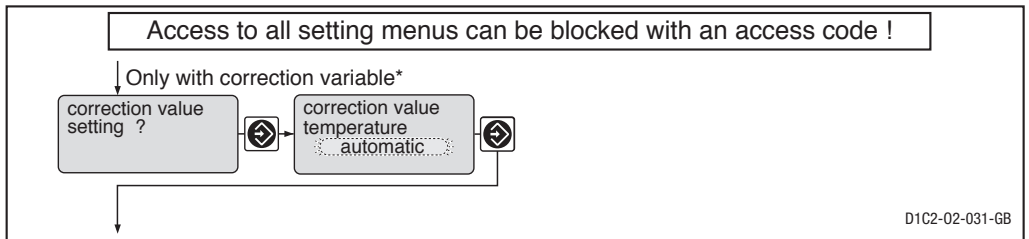

*In the setting menu “correction value” for this equipment enables you to display the temperature or to maintain an mA signal proportional to the temperature. No temperature adjustment is made to the measured variable!

Complete Operating Menu / Description

Pumps

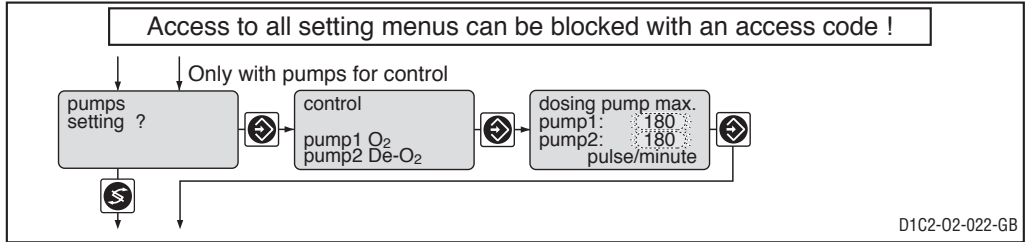

	Initial value	Possible Values			Remarks
		Increment	Lower value	Upper value	
Max. stroke/minute of pumps 1 and 2	180	1	1	500	off = 0 strokes/min

Relay for power control

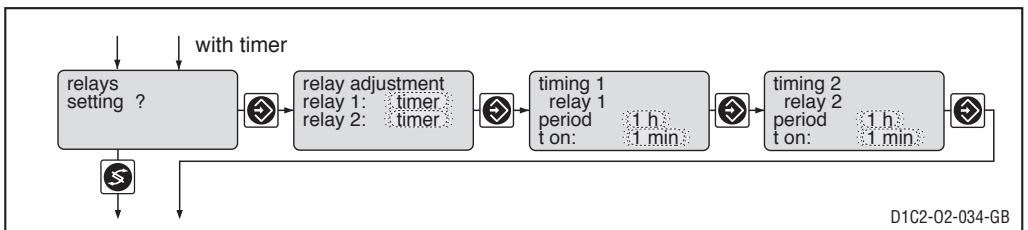
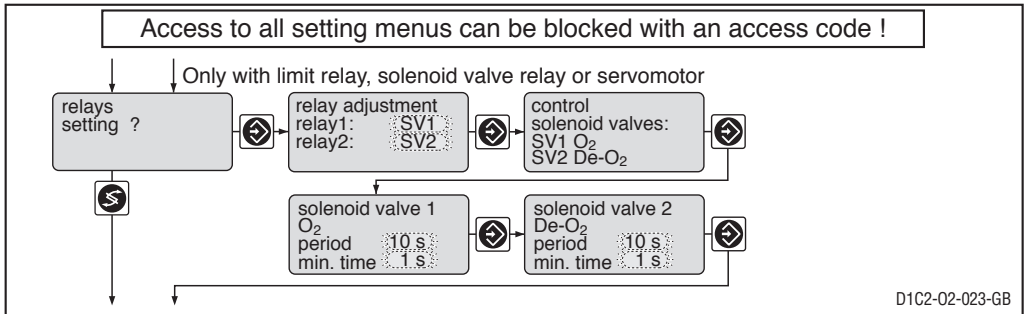

Complete Operating Menu / Description

	Initial value	Possible values			Remarks
		Increment	Lower value	Upper value	
Relay adjustment	as per identity code				
Relay 1		Solenoid valve 1 Limit value 1* Actuator 1 Timer 1 Servomotor off			*In the case of "Limit value" relays remain active even in the event of an error. Only with servomotor
Relay 2		Solenoid valve 2 Limit value 2* Actuator 2 Timer 2 off			
Period (Cycle)	10 s	1 s	10 s	9999 s	for solenoid valve
min. time	1 s	1 s	1 s	period/2	for solenoid valve
Period (Cycle)	off	1 h	1 h / off	240 h	for timer
t on	1 min	1 min	1 min	60 min	for timer

NOTE

The limit value relay can be defined in such a way as to respond as a control element, i.e. if a limit value relay closes a circuit, it opens when a pause contact is activated and/or for a subsequent delay period t_d (if t_d is set to > 0 min in "General settings").

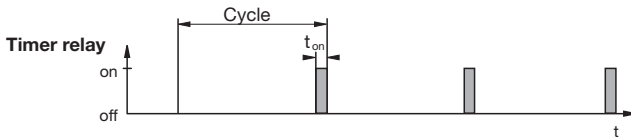

IMPORTANT

The timer will reset in the event of a power failure.

At the end of the (timer) cycle time the DULCOMETER® D1C closes the assigned relay for the duration of "t on" (timer). "Pause" interrupts the timer.

When the clock is shown in the LC display the timer can be reset to the start of the cycle at precisely this point using the enter button.

The % figure in the LC display indicates the progress of the current cycle.

Timer relays may be used, e.g. for shock metering or sensor cleaning.

Complete Operating Menu / Description

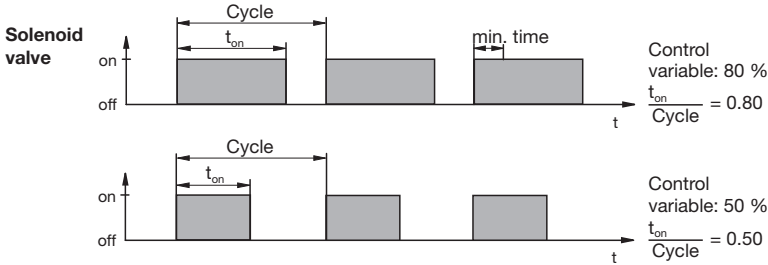

The switching time of the DULCOMETER® D1C (solenoid valve) depends on the actuating variable and the “min. time” (smallest permitted operating factor of the connected device). The actuating variable determines the ratio t_{on}/cycle and thus the switching times (see fig. above). The “min. time” influences the switching times in two situations:

a) theoretical switching time < min. time:

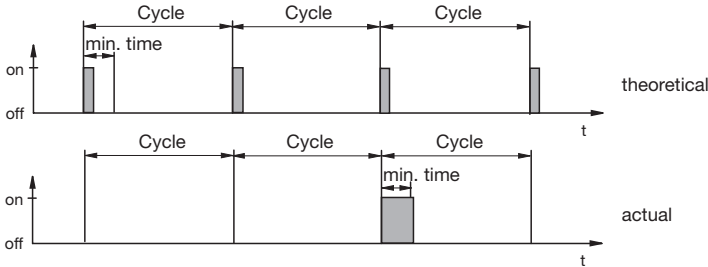

The DULCOMETER® D1C does not switch for a certain number of cycles until the sum of the theoretical switching times exceeds the “min. time”. Then the DULCOMETER® D1C switches for the duration of this total time.

b) theoretical switching time > (cycle - min. time) and calculated switching time < cycle

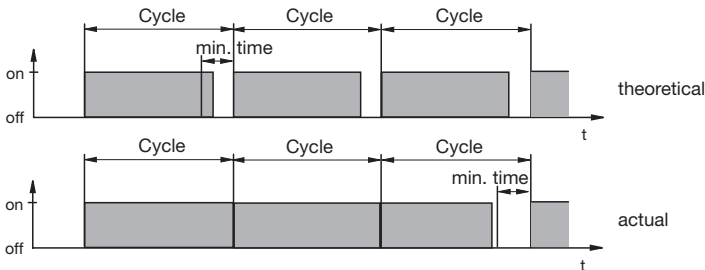

The DULCOMETER® D1C does not deactivate for a certain number of cycles until the differences between cycle and theoretical switching time exceed the “min. time”.

Complete Operating Menu / Description

Limit value

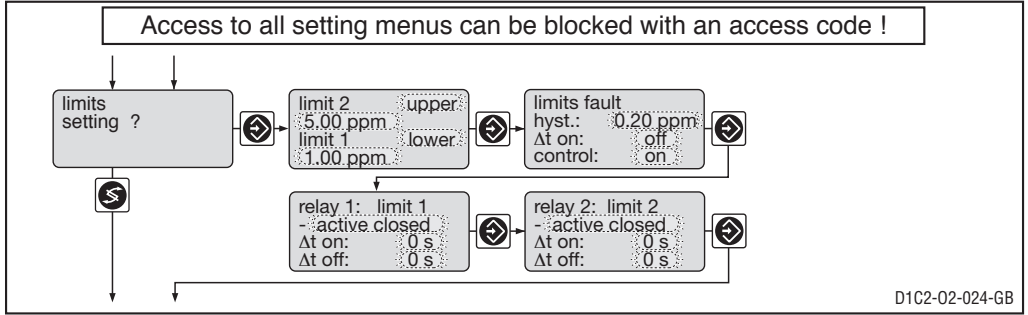

	Initial value	Possible Values			Remarks
		Increment	Lower value	Upper value	
Type of limit transgression	upper Limit 1: lower Limit 2: upper	lower off*			Limit transgression when exceeding or dropping below value *only with limit value relay
Limit value	Limit 1 1.00 ppm	0.01 ppm	-1.00 ppm	11.00 ppm	
	Limit 2 5.00 ppm	0.01 ppm	-1.00 ppm	11.00 ppm	
	Limit 1 2.00 ppm	0.01 ppm	-2.00 ppm	22.00 ppm	
	Limit 2 10.00 ppm	0.01 ppm	-2.00 ppm	22.00 ppm	
	Limit 1 5.00 ppm	0.01 ppm	-5.00 ppm	55.00 ppm	
	Limit 2 25.00 ppm	0.01 ppm	-5.00 ppm	55.00 ppm	
	Limit 1 70.0 %	0.1 %	-10.0 %	110.0 %	
	Limit 2 90.0 %	0.1 %	-10.0 %	110.0 %	
	Limit 1 140.0 %	0.1 %	-20.0 %	220.0 %	
	Limit 2 180.0 %	0.1 %	-20.0 %	220.0 %	
	Limit 1 350.0 %	0.1 %	-50.0 %	550.0 %	
	Limit 2 450.0 %	0.1 %	-50.0 %	550.0 %	
Hysteresis limits	0.20 ppm 0.40 ppm 1.00 ppm 2.0 % 4.0 % 10.0 %	0.01 ppm 0.01 ppm 0.01 ppm 0.1 % 0.1 % 0.1 %	0 ppm 0 ppm 0 ppm 0 % 0 % 0 %	11.00 ppm 22.00 ppm 55.00 ppm 110.0 % 220.0 % 550.0 %	
Delay time, error	off	1 s	1 s / off	9999 s	
Controller	on	on off			
Switch direction, limit value 1/2	Active closed	Active closed Active open			
Switch-on delay Δt on	0 s	1 s	0 s	9999 s	
Switch-off delay Δt off	0 s	1 s	0 s	9999 s	

Complete Operating Menu / Description

Servomotor



IMPORTANT

- Activation of the servomotor must be carried out with the same meticulous care as taken when calibrating a measuring probe.
- For correct function the setting duration of the employed stroke adjustment motor must be more than 25 seconds and less than 180 s for 0...100 % of the setting range. The operating range is defined by the total resistance range of the feedback potentiometer. The maximum limit of the range actually used is set by defining the control range.

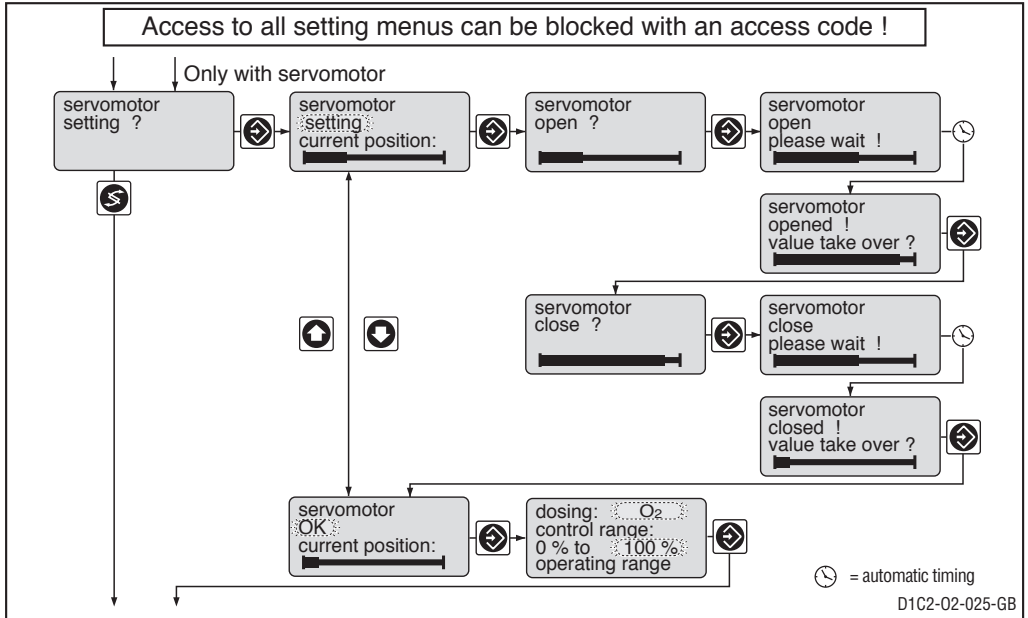

	Initial value	Possible Values			Remarks
		Increment	Lower value	Upper value	
Servomotor	Setting	Setting ok off			
Control direction	O ₂	O ₂ De-O ₂			
Control range	100 %	1 %	10 %	100 %	in % of operating range

NOTE

- When the wide bar is far right the stroke adjustment motor is fully open.
- The permanent display shows the opening amount in % (the greater the percentage the further open the motor).

Complete Operating Menu / Description

Control

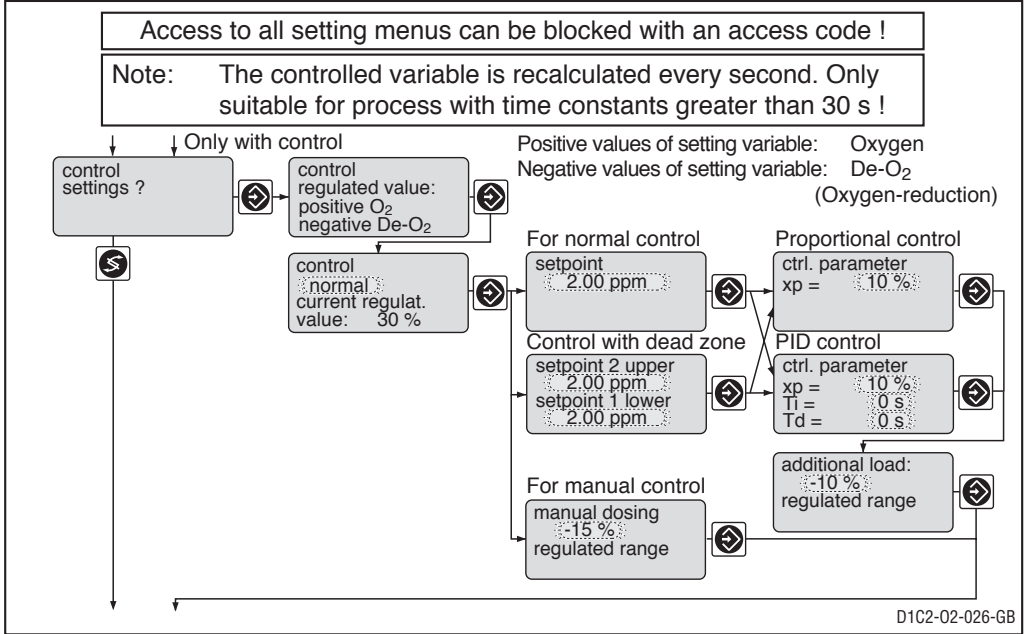

	Initial value	Possible Values			Remarks
		Increment	Lower value	Upper value	
Control	normal	normal with dead zone manual			When controlling with dead zone, the feed forward control is not used for measured values within the dead zone.
Setpoint	2.00 ppm	0.01 ppm	-0.50 ppm	10.50 ppm	2 setpoints necessary for control with dead zone. Setpoint 1 < setpoint 2
	4.00 ppm	0.01 ppm	-1.00 ppm	21.00 ppm	
	10.00 ppm	0.01 ppm	-2.50 ppm	52.50 ppm	
	80.0 %	0.1 %	-5.0 %	105.0 %	
	160.0 %	0.1 %	-10.0 %	210.0 %	
	400.0 %	0.1 %	-25.0 %	525.0 %	
Control parameter xp	10 %	1 %	1 %	500 %	xp referred to measuring range
Control parameter Ti	off	1 s	1 s	9999 s	Function off = 0 s
Control parameter Td	off	1 s	1 s	2500 s	Function off = 0 s
Additional load	0 %	1 %	-100 %	+100 %	
Manual metering	0 %	1 %	-100 %	+100 %	

Abbreviations for control variables:

x_p : 100 %/Kp (inverse proportional coefficient)

T_i : Integration time of I-controller [s]

T_d : Differential time of D-controller [s]

Complete Operating Menu / Description

Feed forward control

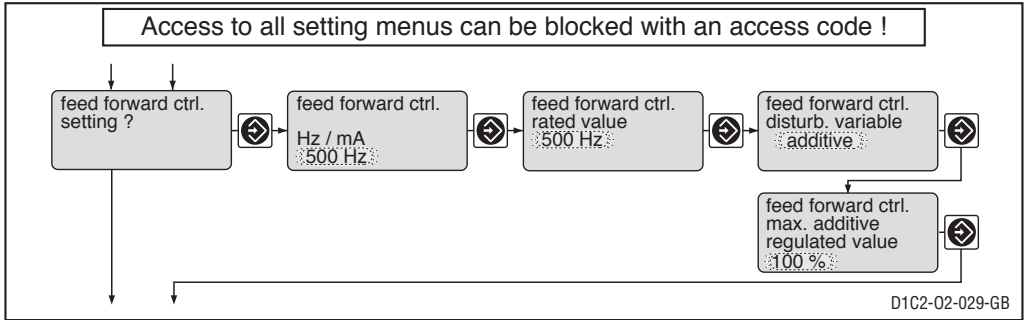

	Initial value	Possible Values			Remarks
		Increment	Lower value	Upper value	
Feed forward control (Flow)	as per identity code	None 10 Hz 500 Hz			Signal processing: Signal <0.02 Hz = No flow Signal <0.2 Hz = No flow Signal <0.2 mA = No flow Signal <4.2 mA = No flow
	Standard signal 4-20 mA	0...20 mA 4...20 mA			
Feed forward control rated value	10 Hz 500 Hz 20 mA	0.01 Hz 1 Hz 0.01 mA	0.1 Hz 5 Hz 0/4 mA	10 Hz 500 Hz 20 mA	Depended on signal type. Maximum limitation of range used.
Feed forward control effect	multiplicative	multiplicative additive			
Max. additive regulated value	100 %	1 %	-500 %	+500 %	only with additive feed forward control

Complete Operating Menu / Description

Standard Signal Output 1

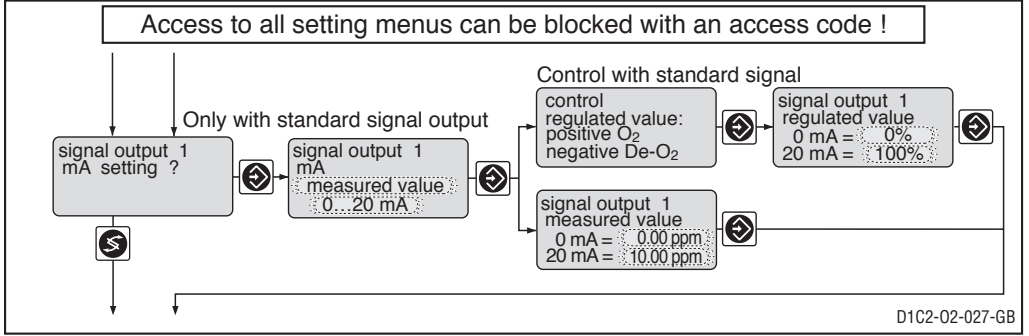

Standard Signal Output 2

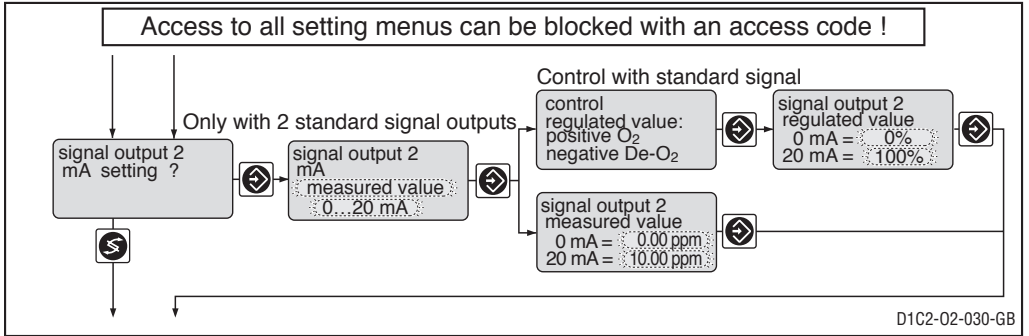

	Initial value	Possible Values			Remarks
		Increment	Lower value	Upper value	
Variable allocation	as per identity code	Measured value Controlled variable			If control applicable
Output range	0...20 mA	0...20 mA 4...20 mA 3.6/4-20 mA			
Range measured value	0...10.00 ppm	0.01 ppm	-1.00 ppm	11.00 ppm	Reduction to 3.6 mA when alarm relay switches (not limit value violation) Minimum range 1 % of measured value
	0...20.00 ppm	0.01 ppm	-2.00 ppm	22.00 ppm	
	0...50.00 ppm	0.01 ppm	-5.00 ppm	55.00 ppm	
	0...100 %	0.1 %	-10.0 %	110.0 %	
	0...200 %	0.1 %	-20.0 %	220.0 %	
Range controlled variable	0...500 %	0.1 %	-50.0 %	550.0 %	Minimum range 1 %
	0 %...+100 %	1 %	-100 %	+100 %	

Complete Operating Menu / Description

General Setting

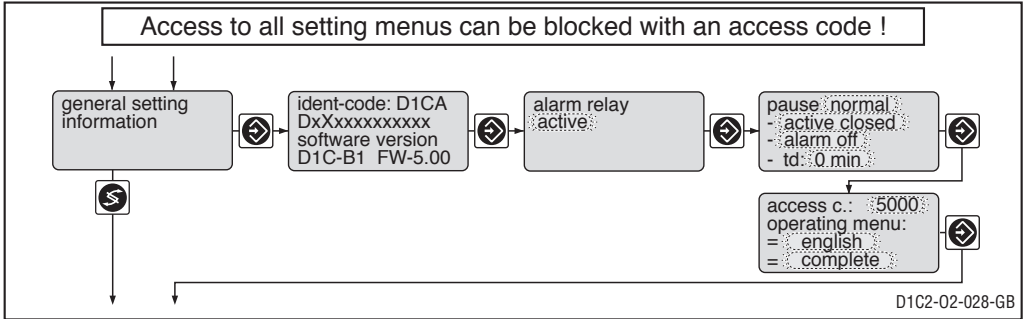

	Initial value	Possible Values			Remarks
		Increment	Lower value	Upper value	
Alarm relay	active	active not active			Alarm relay can be triggered by pause contact
Pause	normal	normal Hold			
Control input pause	active closed	active closed active open			
Alarm Pause	alarm off	alarm off alarm on			
td	0 min	1 min	0 min	60 min	
Access code	5000	1	1	9999	
Language	as per identity code	as per identity code			
Operating menu	complete	restricted complete			

Complete Operating Menu / Description

Standard Pause

If the pause-switch is off, the DULCOMETER® D1C sets the operating outputs to “0” for as long as the pause-switch is off or for a set time-delay t_d (if t_d is set to > 0 min). Whilst the pause-switch is off, the D1C establishes the P-proportion in the background.

With PID-control (Identity code characteristics “control characteristic” = 2): the I-proportion is stored when the pause is switched off (I-proportion then usually only present if $T_i > 0$ has been selected in the “Control setting?” setting menu).

Exception: the standard signal outputs mA for the measured value or correction value are not affected by the pause.

After pause is activated the operating outputs remain at “0” for the length of the time-delay t_d . The time-delay t_d must be set up in such a way that, in this time e.g. sample water (process-specific current concentration) flows to the sensor.

With PID-control (Identity code characteristics “control characteristic” = 2): The control variable output resulting from the pause and the expiry of the time-delay t_d is reconciled jointly with the current P-component and (if T_i is set > 0) with the stored I-component.

Pause Hold

If the pause-switch is off, the DULCOMETER® D1C freezes the operating output at the most recent value for as long as the pause-switch is off or for a set time-delay t_d (if t_d is set to > 0 min). Whilst the pause-switch is off, the D1C establishes the P-proportion in the background.

With PID-control (Identity code characteristics “control characteristic” = 2):

Even the mA standard signal outputs for measured value or correction value are frozen.

After pause is activated the operating outputs remain frozen for the length of the time delay t_d . The time delay t_d must be set up in such a way that, in this time e.g. sample water (process-specific current concentration) flows to the sensor.

With PID-control (Identity code characteristics “control characteristic” = 2): The control variable output resulting from the pause and the expiry of the time-delay t_d is reconciled jointly with the current P-proportion and (if T_i is set > 0) with the newly established I-proportion.

Access Code

Access to the setting menu can be prevented by setting up an access code. The DULCOMETER® D1C controller is supplied with the access code 5000 which permits free access to the setting menu. The calibration menu remains freely accessible even when access to the setting menu is blocked by the code.

9 Fault / Remarks / Troubleshooting

Fault	Fault text	Symbol	Effect on metering	Effect on control	Alarm with ack- nowledgement	Remarks	Remedy
Measured variable Checkout time measured value exceeded	Check O_2 probe	☹	Basic load	Stop	Yes	Function defeatable	Check function of probe
- Out of range signal - Undershooting signal*	O_2 -inp = 0 mA O_2 -inp ≤ 4 mA O_2 -inp > 22 mA	☹	Basic load Basic load**	Stop Stop**	Yes Yes**		Check probe, transducer and cable connection measuring range increase if required
- Excess signal			Basic load	Stop	Yes		
- Calibration error	O_2 -calib. defective		Basic load	Stop	No		
Correction variable Signal exceeded/drops below value	Check te-input	☹			yes	PT100-signal >138,5 Ω Signal <3,0 ±0,2 mA or >23 ±0,2 mA Value last valid is used	Check probe, transducer and cable connection
Feed forward control mA - Undershooting signal multiplicative additive	feedfwd. < 4 mA feedfwd. > 23 mA	☹ ☹	Stop		Yes Yes	Feed forward ctrl. = 0% Feed forward ctrl. = 100%	
Limit transgression after checkout time Control "on" Control "off"	O_2 -limit 1 O_2 -limit 2	☹ ☹	Stop or Basic load	Stop	Yes Yes	Function defeatable	Define cause, reset values if necessary
Servomotor Position not reached	Servomotor defective	☹			Yes	Servomotor closes	Check servomotor
Electronics error	System error	☹	Stop	Stop	Yes	Elektronik data defective	Call in service
Operation	Note text	Symbol	Effect on metering	Effect on control	Alarm with ack- nowledgement	Remarks	Remedy
Pause contact	Pause	☹	Stop	Stop	Yes/No***	No further fault check	-
	Pause/Hold	☹		PI proportion frozen			
Stop button	Stop	☹	Stop	Stop	Yes/No	Relay drops out	-
During servomotor setting Position feed back wrong Upper position <40 % max. value Lower position >30 % range	Direction check Final value small Final value big					Without correct adjustment the last valid values are still used	Check connection of relay, potentiometer Adjust the operation region of the servomotor correctly

* also in calibration of the DULCOTEST® sensor for released oxygen

** reactions first occur after 10 min. Until then error evaluation is suspended and the "measured variable" output is frozen.

*** depending on whether "Alarm on" or "Alarm off" set in "General settings"

