



Operating Instructions DULCOMETER® D1C

Part 2: Adjustment and Operation,
Measured Variable Ozone

D1C2-03-001-GB



Type D



Type W

D1C A

Please enter the identity code of your device here!

Please completely read through operating instructions! · Do not discard!
The operator shall be liable for any damage caused
by installation or operating errors!

1 Device Identification / Identity Code

D1C A	DULCOMETER® Controller Series D1C / Version A	
	Type of mounting	
D	Control panel installation 96 x 96 mm	
W	Wall mounting	
	Operating voltage	
0	230 V 50/60 Hz	
1	115 V 50/60 Hz	
2	200 V 50/60 Hz (only with panel installation)	
3	100 V 50/60 Hz (only with panel installation)	
4	24 V AC/DC	
	Measured variable	
Z	Ozone	
	Connection of measured variable	
1	Terminal, standard signal 0/4-20 mA	
	Correction variable	
0	None	
2	Temperature (PT100) via terminal	
3	Temperature via standard signal 0/4-20 mA	
	Feed forward control	
0	None	
1	via standard signal 0/4-20 mA	
2	via frequency 0-500 Hz	
3	via frequency 0-10 Hz	
	Control input	
0	None	
1	Pause	
	Signal output	
0	none	
1	Standard signal 0/4-20 mA measured value	
2	Standard signal 0/4-20 mA control variable	
3	Standard signal 0/4-20 mA correction variable	
4	2 standard signal 0/4-20 mA outputs, free programmable	
	Power control	
G	Alarm and 2 limit value/timer relays	
M	Alarm and 2 solenoid valve relays	
R	Alarm relay and servomotor with feedback	
	Pump control	
0	None	
2	Two pumps	
	Control characteristic	
0	None	
1	Proportional control	
2	PID control	
	Log output	
0	None	
	Language	
D	German	
E	English	
F	French	
I	Italian	
N	Dutch	
S	Spanish	
P	Polish	
A	Swedish	
U	Hungarian	
G	Czech	
D1C A	_____	

Please enter the identity code of your device here!

2 General User Information

	Page
1 Device Identification / Identity Code	2
2 General User Information	3
3 Device Overview / Controls	4
4 Functional Description	5
5 Display Symbols	6
6 Operation	7
7 Restricted Operating Menu	8
Layout	8
Description	9
8 Complete Operating Menu	12
Overview	12
Description	13
9 Faults/Remarks/Troubleshooting	24

General User Information

These operating instructions describe the technical data and function of the series D1C DULCOMETER® controller, provide detailed safety information and are divided into clear steps.



IMPORTANT

- *Please observe the parts of these operating instructions applicable to your particular version! This is indicated in the Section “Device Identification / Identity Code”!*
- *Correct measuring and dosing is only possible in the case of impeccable operation of the probe. The probe has to be calibrated / checked regularly!*

NOTE

A form “Documentation of controller settings Type D1C” is available under www.prominent.com/documentation_D1C for purpose of documenting the controller settings.

3 Device Overview / Controls

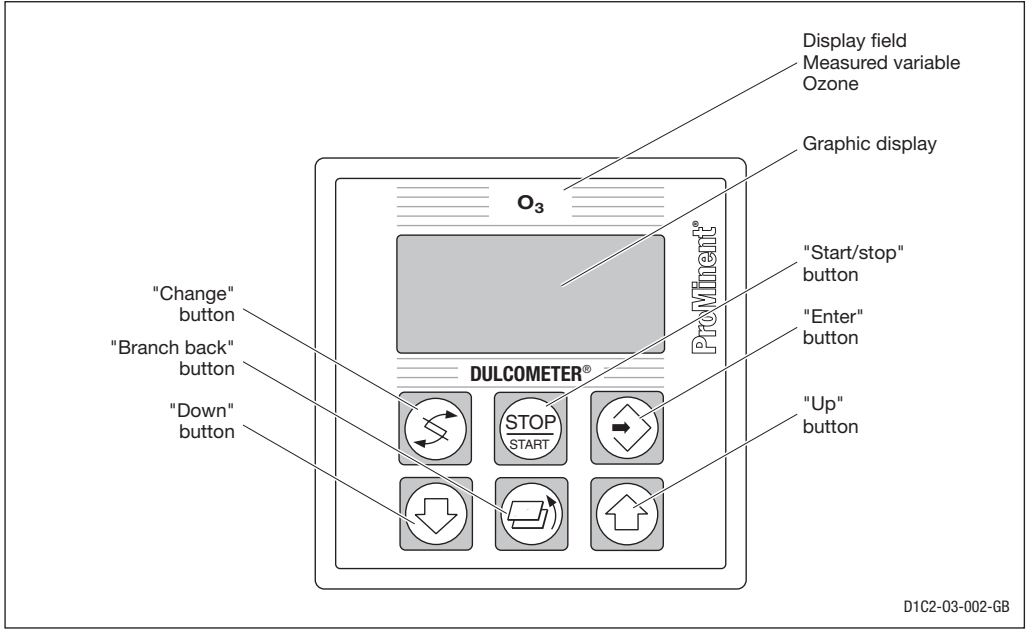

	<p>CHANGE button</p> <p>To change over within a menu level and to change from one variable to another within a menu point.</p>
	<p>START/STOP button</p> <p>Start/stop of control and metering function.</p>
	<p>ENTER button</p> <p>To accept, confirm or save a displayed value or status. For alarm acknowledgement.</p>

	<p>UP button</p> <p>To increase a displayed numerical value and to change variables (flashing display)</p>
	<p>BRANCH BACK button</p> <p>Back to permanent display or to start of relevant setting menu.</p>
	<p>DOWN button</p> <p>To decrease a displayed numerical value and to change variables (flashing display).</p>

4 Functional Description

NOTE

Please refer to the description of the complete operating menu in Section 8 for a detailed description of the individual characteristics of the D1C controller!

4.1 Operating Menu

The DULCOMETER® D1C controller permits settings to be made in two different menus. All values are preset and can be changed in the **complete operating menu**.

The controller is delivered with a **restricted operating menu** so that the D1C controller can be used effectively in many applications from the very onset. If adaptations prove to be necessary, all relevant parameters can then be accessed by switching over to the complete operating menu (see "General settings").

4.2 Access Code

Access to the setting menu can be prevented by setting up an access code. The DULCOMETER® D1C controller is supplied with the access code 5000 which permits free access to the setting menu. The calibration menu remains freely accessible even when access to the setting menu is blocked by the code.

4.3 Control

The D1C can operate as a proportional controller or as a PID controller - dependent on the device version (see identity code) and the setting.

The controlled variable is recalculated once a second. Control procedures which require rapid correction of setpoint deviations (less than approx. 30 seconds) cannot be processed with this controller. The cycle times must be taken into consideration when activating solenoid valves (pulse length) in the same way as their running times when activating servomotors (3-point).

Via the control input pause, the control function (selection of controlled variable) can be switched off. The calculation of the controlled variable starts again after cessation of "pause".

4.4 Feed Forward Control

The D1C controller can process a signal of a feed forward control. Depending on the device version (see identity code) and the setting, this signal can be obtained in any form of a 0–20 mA or 4–20 mA signal or as a digital contact signal with the maximum frequencies 10 Hz or 500 Hz.

This signal can be used, for example, for flow-proportional metering (multiplicative effect) or feed forward-dependent basic load metering (additive effect). The result of control variable calculation from the proportional or PID control is multiplied by or added to the feed forward signal. A multiplicative feed forward variable at the level of the set rated value carries over the calculated control variable unchanged into the controlled variable:

$$\text{Control variable} = \text{Feed forward variable/rated value} \times \text{calculated control variable}$$

During start-up, the zero point has to be checked. The multiplicative feed forward control is not designed for switching off permanently the actuating variable (signal \approx 0).

An additive feed forward variable at the level of the rated value results in maximum control variable:

$$\text{Control variable (max. 100 \%)} = \text{Feed forward variable/rated value} \times \text{max. control variable} + \text{calculated control variable}$$

4.5 Error Messages

Error messages and information are indicated on the bottom line in the permanent display 1. Errors to be acknowledged (acknowledgement switches off the alarm relay) are indicated by the "E". Errors/notes which still apply after acknowledgement are indicated alternately. During correction variable processing (temperature for correction of pH-value), the value is indicated in the same line as the error/note. Faults which are rectified of their own accord due to changed operating situations are removed from the permanent display without the need for acknowledgement.

5 Display Symbols

The display of the DULCOMETER® D1C controller uses the following symbols:

Description	Comment	Symbol
Limit value transgression Relay 1, upper	Symbol left	↑
Relay 1, lower	Symbol left	↓
Relay 2, upper	Symbol right	↑
Relay 2, lower	Symbol right	↓
Metering pump 1 (ozone) Control off	Symbol left	■
Control on	Symbol left	□
Metering pump 2 (De-ozone) Control off	Symbol right	■
Control on	Symbol right	□
Solenoid valve 1 (ozone) Control off	Symbol left	▲
Control on	Symbol left	△
Solenoid valve 2 (De-ozone) Control off	Symbol right	▲
Control on	Symbol right	△
Servomotor Control, open relay		▲ △
Control, close relay		△ ▲
Without control		▲ ▲
Position feedback	Thickness of bar increases from left to right during opening	▬
Stop button pressed		O
Manual metering		M
Fault		ε

6 Operation

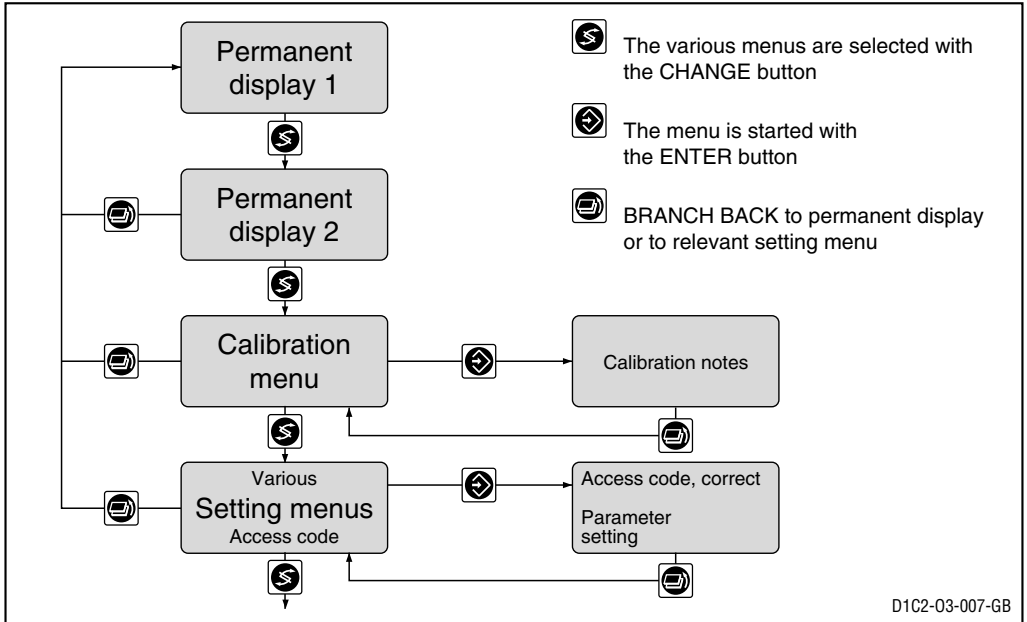

NOTE

Access to the setting menus can be barred with the access code!

The number and scope of setting menus is dependent on the device version!

If the access code is selected correctly in a setting menu, then the following setting menus are also accessible!

If within a period of 10 minutes no button is pushed, the unit automatically branches back from the calibrating menu or a setting menu to the permanent display 1!

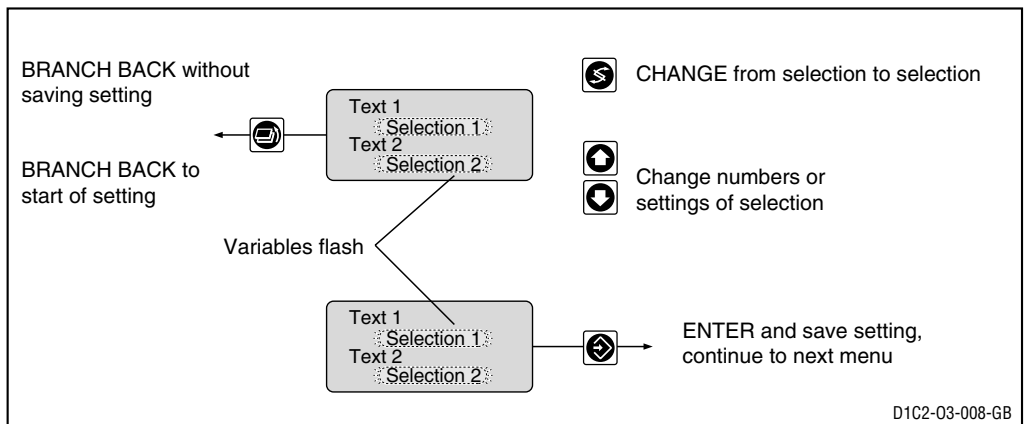

7 Restricted Operating Menu / Layout

The restricted operating menu permits simple operation of the most important parameters. The following overview shows the settings which can be selected.

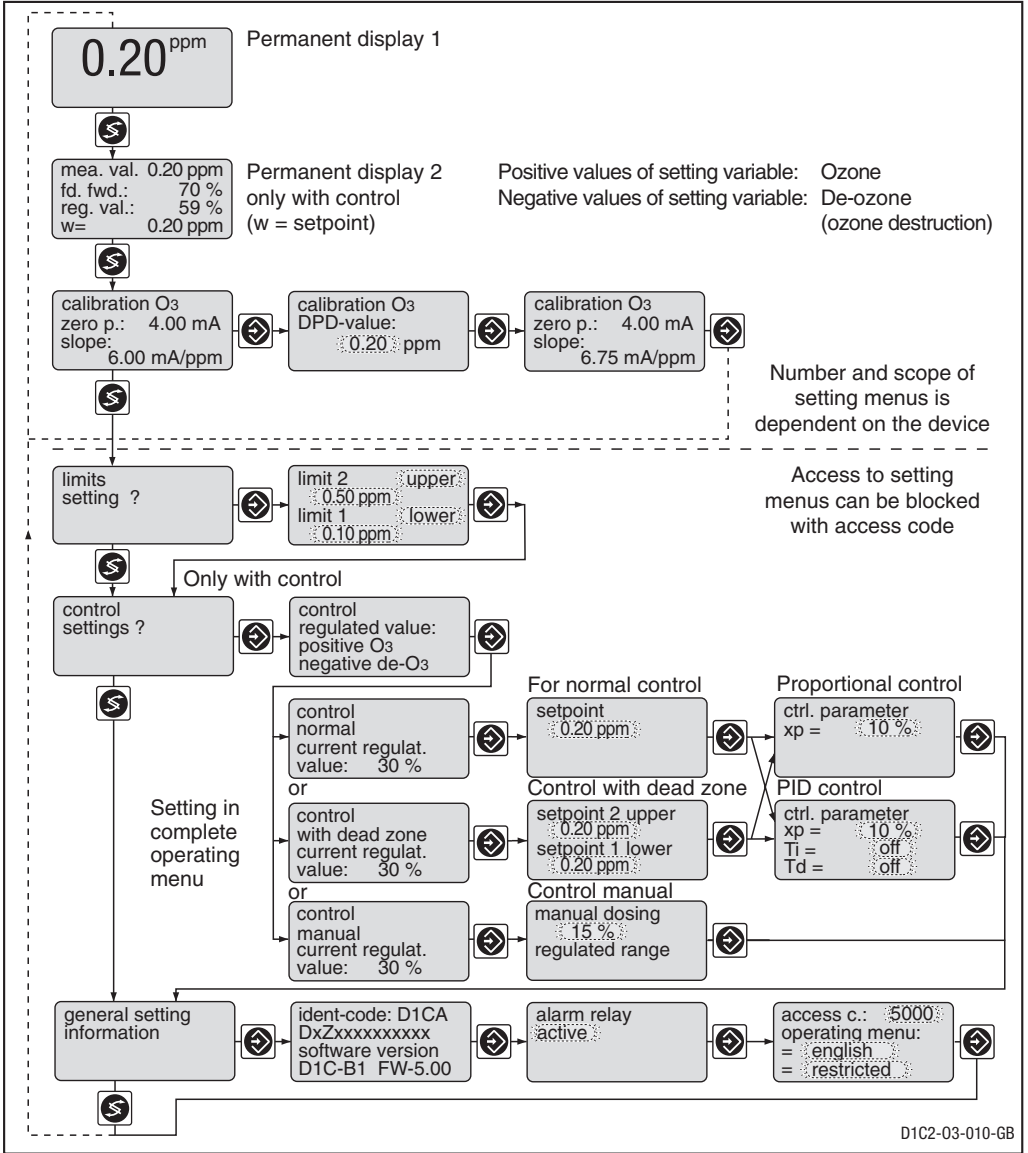

Restricted Operating Menu / Description

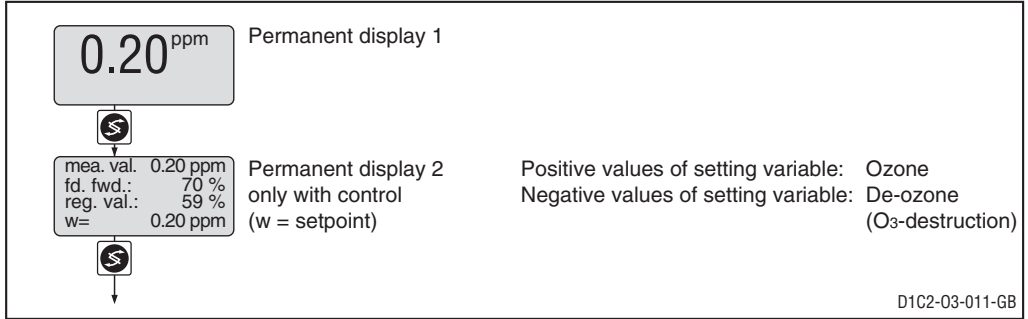

Calibration the Ozone Probe

During the calibration, the D1C sets the control variable to "0". Exception: If a base load or manual control variable was set, these are maintained during the calibration. The standard signal outputs mA (measured value or correction value) are frozen. The measured value registered during the start of the calibration is proposed as the DPD value; this value is adjustable (arrow keys). Calibration is only possible if the DPD value is $\geq 2\%$ of the measuring range. On successful completion of calibration, all error checks which refer to the measured value are restarted.



IMPORTANT

The measuring range of the probe must agree with the set measuring range (factory setting: 0-2 ppm). The measuring range must be reset prior to calibration (refer to page 14 "Measured value setting").

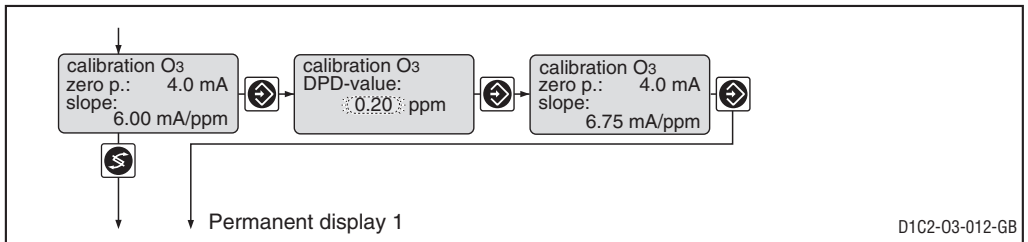

	Initial value	Possible values			Remark
		Increment	Lower value	Upper value	
	Measured value	0.01 ppm	0 ppm	20 ppm	

Error message	Condition	Remarks
Calibration O ₃ not possible! Probe slope too low	O ₃ slope too low ($<25\%$ of norm slope)	Calibrate again
Calibration O ₃ not possible! Probe slope too high	O ₃ slope too high ($>300\%$ of norm slope)	Calibrate again
DPD value too low DPD $> x.xx$ ppm	DPD $<2\%$ of the measuring range	Calibrate again after adding ozone

Restricted Operating Menu / Description

Limits

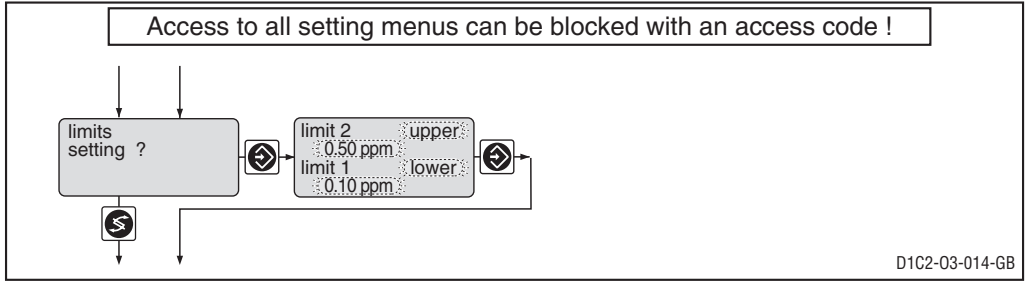

	Initial value	Possible values			Remark
		Increment	Lower value	Upper value	
Type of limit transgression	Limit 1: Limit 2:	lower upper	upper lower off*		Limit transgression when exceeding or dropping below value *only with limit relays
Limit value	Limit 1: Limit 2:	0.1 ppm 0.5 ppm	0.01 ppm 0.01 ppm	0.00 ppm 0.00 ppm	

Control

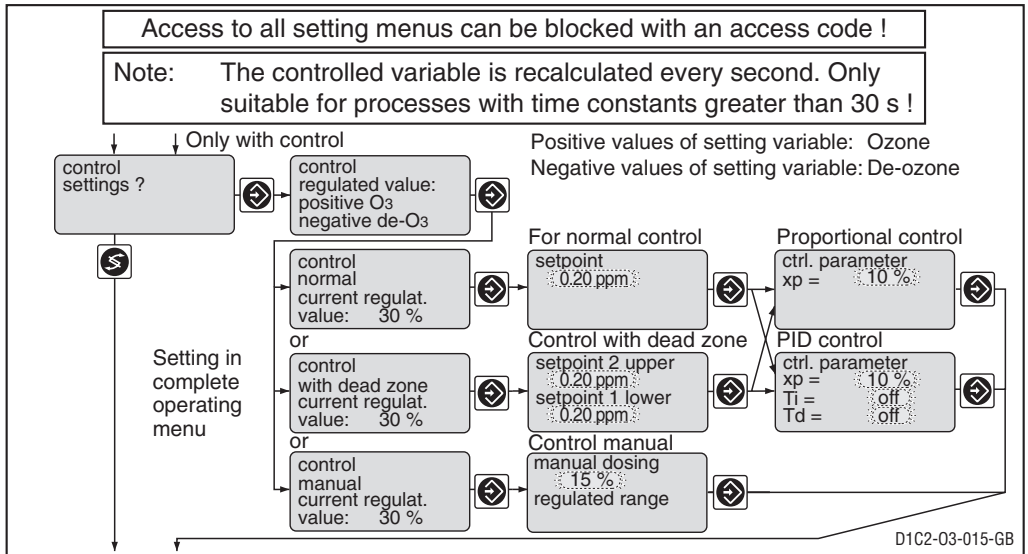

Restricted Operating Menu / Description

	Initial value	Possible values			Remarks
		Increment	Lower value	Upper value	
Setpoint	0.20 ppm	0.01 ppm	lower limit measuring range	upper limit measuring range	2 setpoints necessary for control with dead zone. Setpoint 2 < Setpoint 1
Control parameter xp	10 %	1 %	1 %	500 %	xp referred to measuring range
Control parameter Ti	off	1 s	1 s	9999 s	Function off = 0 s
Control parameter Td	off	1 s	1 s	2500 s	Function off = 0 s
Manual metering	15 %	1 %	-100 %	+100 %	

Abbreviation for control variables:

x_p = 100 %/Kp (inverse proportional co-efficient)

T_i = I controller integration time [s]

T_d = D controller differential time [s]

General Settings

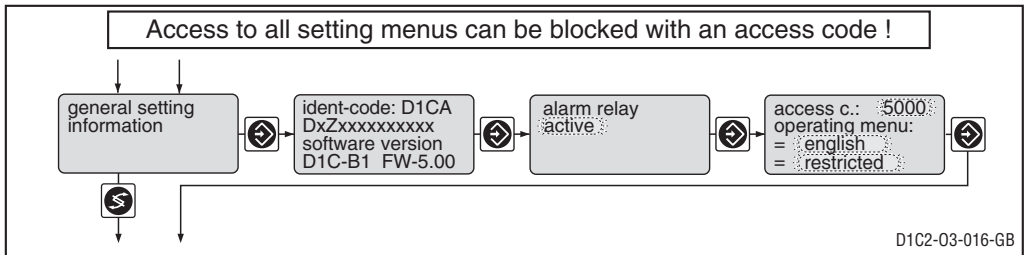

	Initial value	Possible values			Remarks
		Increment	Lower value	Upper value	
Alarm relay	active	active not active			
Access code	5000	1	1	9999	
Language	as per identity code	as per identity code			
Operating menu	restricted	restricted complete			

Access Code

Access to the setting menu can be prevented by setting up an access code. The DULCOMETER® D1C controller is supplied with the access code 5000 which permits free access to the setting menu. The calibration menu remains freely accessible even when access to the setting menu is blocked by the code.

8 Complete Operating Menu / Overview

All parameters of the controller can be set in the complete operating menu (Access, see previous page). The following overview shows the settings which can be selected:

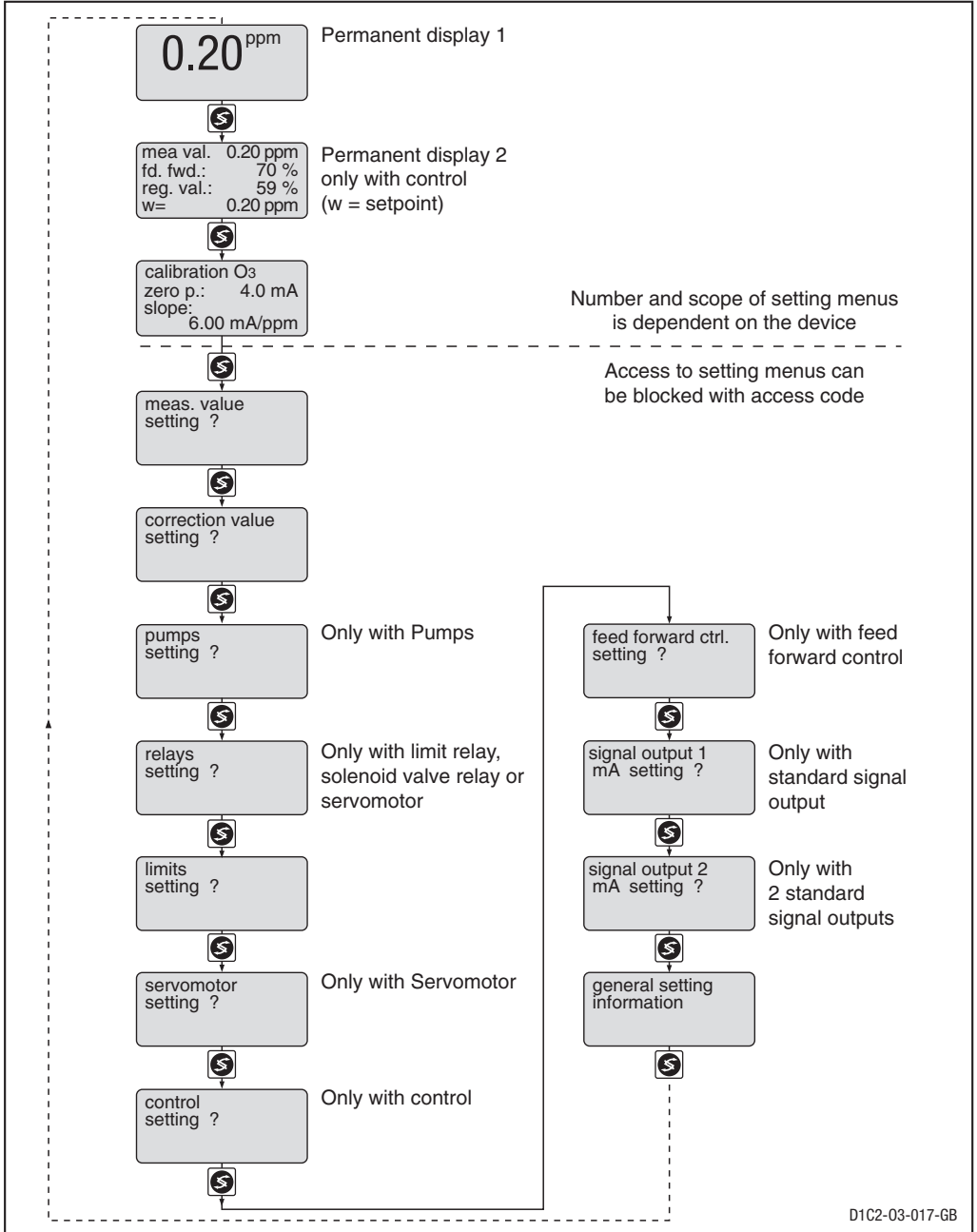

Complete Operating Menu / Description

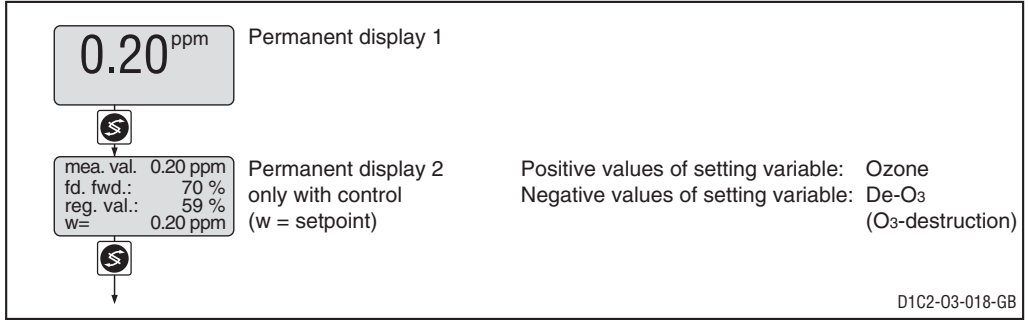

Calibration the Ozone Probe

During the calibration, the D1C sets the control variable to "0". Exception: If a base load or manual control variable was set, these are maintained during the calibration. The standard signal outputs mA (measured value or correction value) are frozen. The measured value registered during the start of the calibration is proposed as the DPD value; this value is adjustable (arrow keys). Calibration is only possible if the DPD value is $\geq 2\%$ of the measuring range. On successful completion of calibration, all error checks which refer to the measured value are restarted.



IMPORTANT

The measuring range of the probe must agree with the set measuring range (factory setting: 0-2 ppm). The measuring range must be reset prior to calibration (refer to page 14 "Measured value setting").

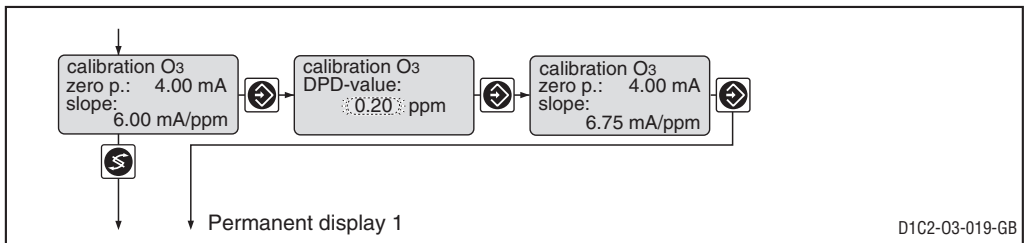

	Initial value	Possible values		Upper value	Remark
	Measured value	Increment	Lower value		
		0.01 ppm	0 ppm	20 ppm	

Error message	Condition	Remark
Calibration O ₃ not possible! Probe slope too low	O ₃ slope too low ($<25\%$ of norm slope)	Calibrate again
Calibration O ₃ not possible! Probe slope too high	O ₃ slope too high ($>300\%$ of norm slope)	Calibrate again
DPD value too low DPD $> x.xx$ ppm	DPD $<2\%$ of the measuring range	Calibrate again after adding ozone

Complete Operating Menu / Description

Measured Value

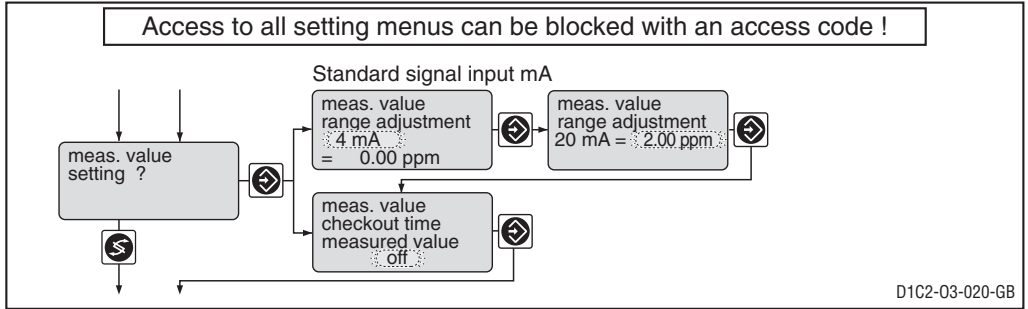

IMPORTANT

When changing the range adjustment, the ozone probe must be new calibrated and the adjustments in all menus have to be checked!

Measured value control period



IMPORTANT

This function may not be activated for applications in which it can be assumed that the measured value will not change.

This function tests whether the measured value changes from that of the probe (at the measured value input) within the "Measured value control period". It is assumed that it will do so for an intact probe. If the measuring value does not change during this control time, the DULCOMETER® D1C sets the control variable to „0“ and the alarm relay drops out. The LCD display shows e.g. the message "Check O₃ probe".

	Initial value	Possible values			Remarks
		Increment	Lower value	Upper value	
Standard signal input lower signal limit	4 mA	0 mA 4 mA			
Allocated measured value lower	0 ppm		0.00 ppm		
upper	2 ppm	0.01 ppm		20.00 ppm	
Checkout time	off	1 s	1 s	9999 s	Constant measurement signal results in message and alarm. Function off = 0 s

Correction Variable*

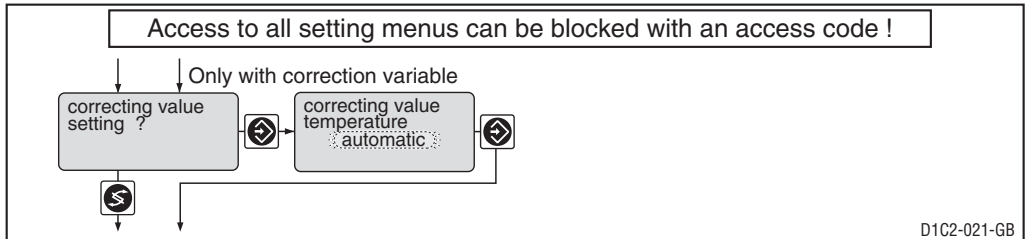

*The setting menu "Correction variable" enables this device to display the temperature or to receive a temperature-proportional mA signal. There will be no temperature correction of the measured value!

Complete Operating Menu / Description

	Initial value	Possible values			Remarks
		Increment	Lower value	Upper value	
Type of temperature compensation	as per identity code	Manual Automatic off			Changeover only if specified in identity code = automatic
Manual temperature compensation	25 °C	0.1 °C	0 °C	100 °C	

Pumps

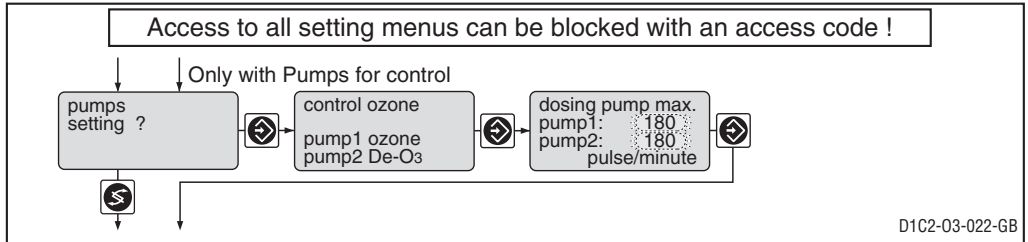

	Initial value	Possible values			Remarks
		Increment	Lower value	Upper value	
Max. stroke/minute of pumps 1 and 2	180	1	1	500	off = 0 strokes/min

Relay for power control

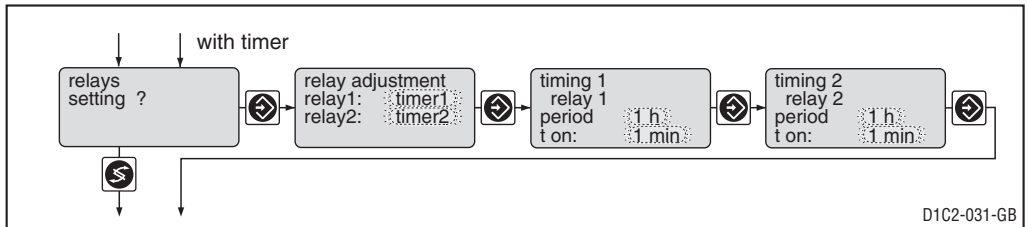
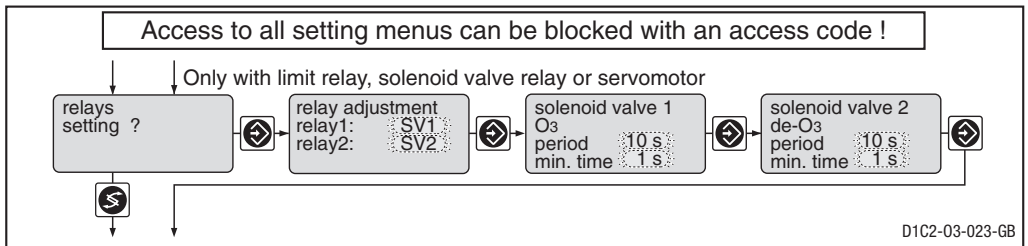

Complete Operating Menu / Description

	Initial value	Possible values			Remarks
		Increment	Lower value	Upper value	
Relay adjustment	as per identity code				
Relay 1		Solenoid valve 1 Limit value 1* Actuator 1 Timer 1 Servomotor off			*At "limit value" the relays remain active also in the case of fault. Only with servomotor
Relay 2		Solenoid valve 2 Limit value 2* Actuator 2 Timer 2 off			
Cycle min. time	10 s 1 s	1 s 1 s	10 s 1 s	9999 s Cycle/2	for solenoid valve for solenoid valve Set here the smallest permitted operating factor of the connected device.
Cycle t on	off 1 min	1 h 1 min	1 h/off 1 min	240 h 60 min	for timer for timer

NOTE

The limit value relay can be defined in such a way as to respond as a control element, i.e. if a limit value relay closes a circuit, it opens when a pause contact is activated and/or for a subsequent delay period t_d (if t_d is set to > 0 min in "General settings").

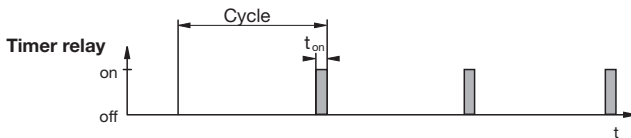

IMPORTANT

The timer will be reset if there is a drop in the power supply.

At the end of the (timer) cycle time, the DULCOMETER® D1C closes the assigned relay for the duration of "t on" (timer). "Pause" interrupts the timer.

When the clock is shown in the LC display, the timer can be reset to the start of the cycle at precisely this point using the enter button.

The % figure in the LC display indicates the progress of the current cycle.

Timer relays may be used, e.g. for shock metering or sensor cleaning.

Complete Operating Menu / Description

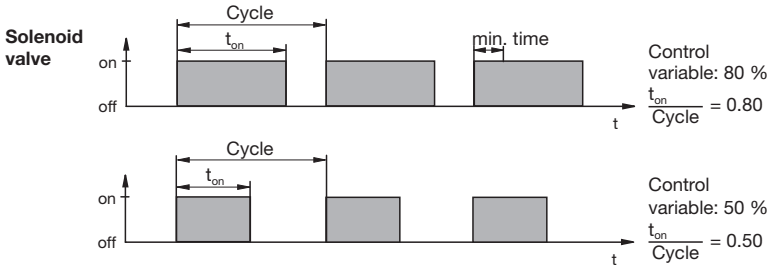

The switching time of the DULCOMETER® D1C (solenoid valve) depends on the actuating variable and the "min. time" (smallest permitted operating factor of the connected device). The actuating variable determines the ratio t_{on}/cycle and thus the switching times (see fig. above). The "min. time" influences the switching times in two situations:

a) theoretical switching time < min. time:

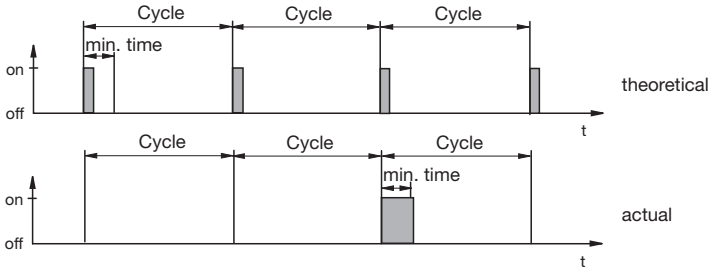

The DULCOMETER® D1C does not switch for a certain number of cycles until the sum of the theoretical switching times exceeds the "min. time". Then the DULCOMETER® D1C switches for the duration of this total time.

b) theoretical switching time > (cycle - min. time) and calculated switching time < cycle

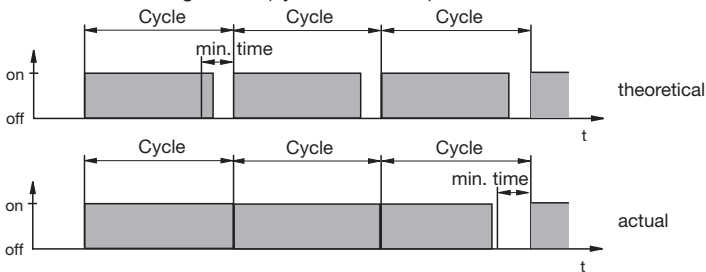

The DULCOMETER® D1C does not deactivate for a certain number of cycles until the differences between cycle and theoretical switching time exceed the "min. time".

Complete Operating Menu / Description

Limits

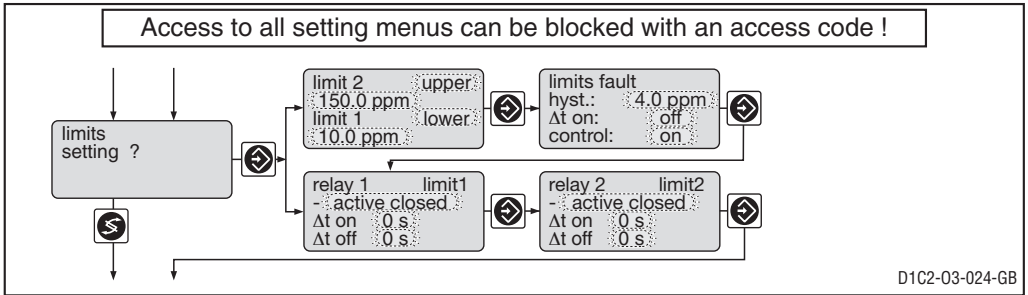

	Initial value	Possible values			Remarks
		Increment	Lower value	Upper value	
Type of limit transgression Limit 1: Limit 2:	lower upper	upper lower off*			Limit transgression when exceeding or dropping below value *only with limit relays
Limit value Limit 1: Limit 2:	0.10 ppm 0.50 ppm	0.01 ppm 0.01 ppm	0.00 ppm 0.00 ppm	20.00 ppm 20.00 ppm	
Hysteresis limits	0.04 ppm	0.01 ppm	0.02 ppm	20.00 ppm	Effective in direction of "cancelling limit transgression" Results in message and alarm. off = 0 s: Function switched off, no message, no alarm.
Checkout time limits t on	off	1 s	off	9999 s	
Control	on	on off			Acts as N/O Acts as N/C
Switching direction Limit value 1, Limit value 2	active closed	active closed active open			
Switch-on delay Δt on	0 s	1 s	0 s	9999 s	
Switch-off delay Δt off	0 s	1 s	0 s	9999 s	

If the limit is exceeded for longer than the "delay time - limit values" an error message is given, which must be acknowledged, and the alarm relay circuit is broken. If "control" is also set to "off" the control process stops.

Complete Operating Menu / Description

Servomotor

The **operating range** is defined by the total resistance range of the feedback potentiometer. The maximum limit of the range actually used is set by defining the **control range**.



IMPORTANT

- To ensure correct operation, the activation time of the actuator used should not be less than 25 seconds for the control range from 0...100 %!
- Activation of the servomotor must be carried out with the same meticulous care as taken when calibrating a measuring probe.

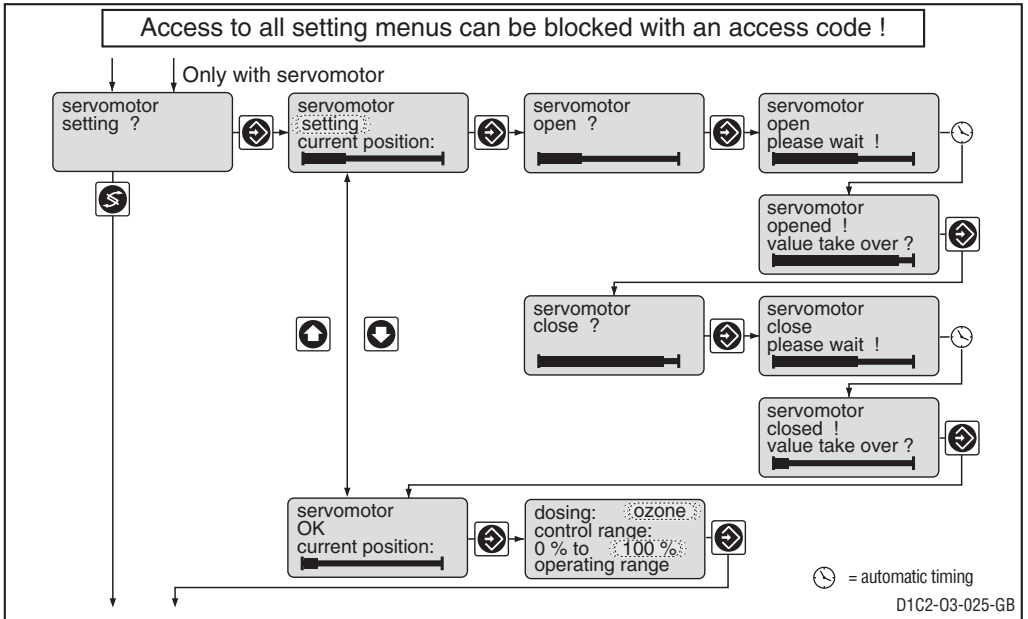

	Initial value	Possible values			Remarks
		Increment	Lower value	Upper value	
Servomotor	setting	setting OK off			
Control direction	Ozone	Ozone de-ozone			
Control range	100 %	1 %	10 %	100 %	in % of operating range

NOTE

- When the wide bar is as right as it will go the stroke adjustment motor is fully open.
- The permanent display shows to what degree the motor has opened in % (the greater the percentage, the farther open the stroke adjustment motor.)

Complete Operating Menu / Description

Control

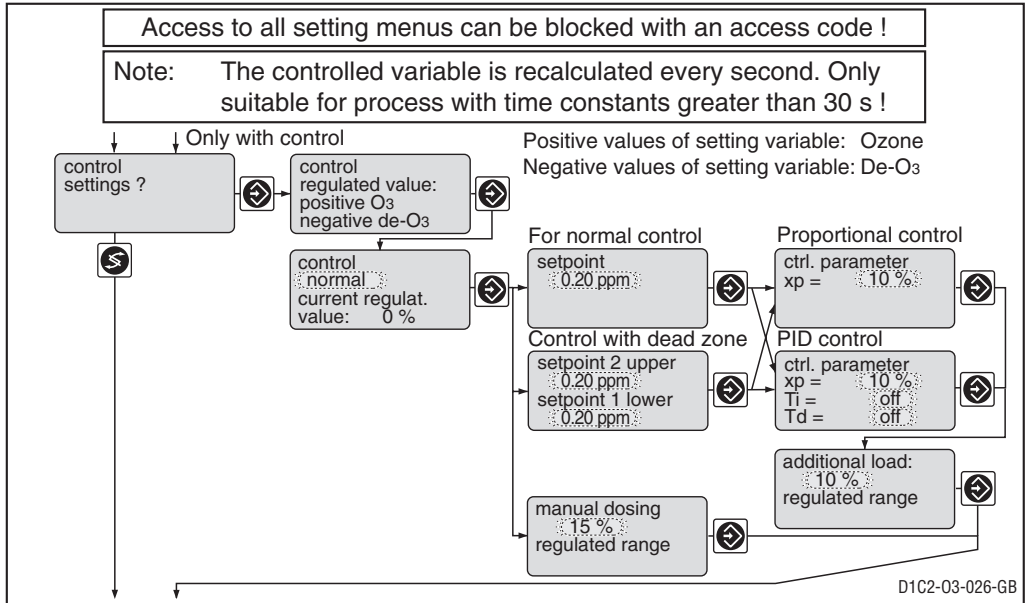

	Initial value	Possible values			Remarks
		Increment	Lower value	Upper value	
Control	normal	normal with dead zone manual			When controlling with dead zone, the feed forward control is not used for measured values within the dead zone.
Setpoint	0.20 ppm	0.01 ppm	Lower measurement range limit	Lower measurement range limit	2 setpoints necessary for control with dead zone. Setpoint 1 < setpoint 2
Control parameter xp	10 %	1 %	1 %	500 %	xp referred to measuring range
Control parameter Ti	off	1 s	1 s	9999 s	Function off = 0 s
Control parameter Td	off	1 s	1 s	2500 s	Function off = 0 s
Additional load	0 %	1 %	-100 %	+100 %	
Manual metering	15 %	1 %	-100 %	+100 %	

Abbreviation for control variables:

x_p = 100 %/Kp (inverse proportional co-efficient)

T_i = I controller integration time [s]

T_d = D controller differential time [s]

Complete Operating Menu / Description

Feed forward control

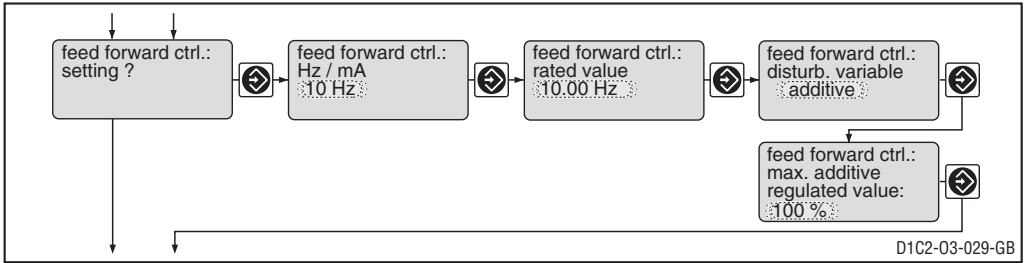

	Initial value	Possible values			Remarks
		Increment	Lower value	Upper value	
Feed forward control (Flow)	as per identity code	None 10 Hz 500 Hz			Signal processing: Signal <0,02 Hz = No flow Signal <0,2 Hz = No flow Signal <0,2 mA = No flow Signal <4,2 mA = No flow
	Standard signal 4-20 mA	0...20 mA 4...20 mA			
Feed forward control rated value	10 Hz 500 Hz 20 mA	0.01 Hz 1 Hz 0.1 mA	0.1 Hz 5 Hz 0/4 mA	10 Hz 500 Hz 20 mA	Depended on signal type. Maximum limitation of range used.
Feed forward control effect	multiplicative	multiplicative additive			
Max. additive regulated value	100 %	1 %	-500 %	+500 %	only with additive feed forward control

Standard Signal Output 1

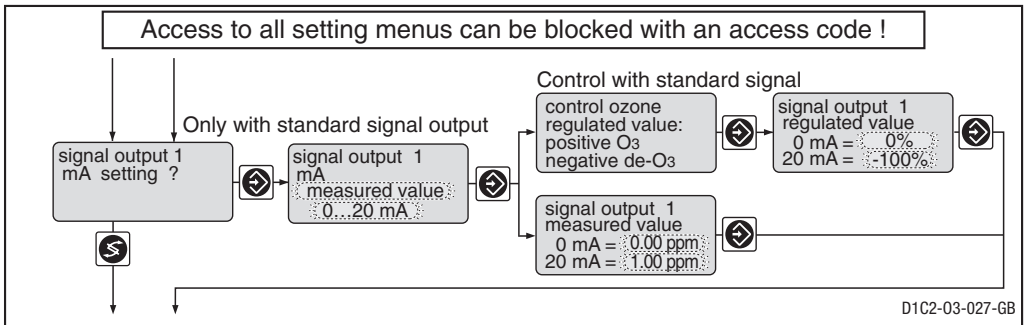

Complete Operating Menu / Description

Standard Signal Output 2

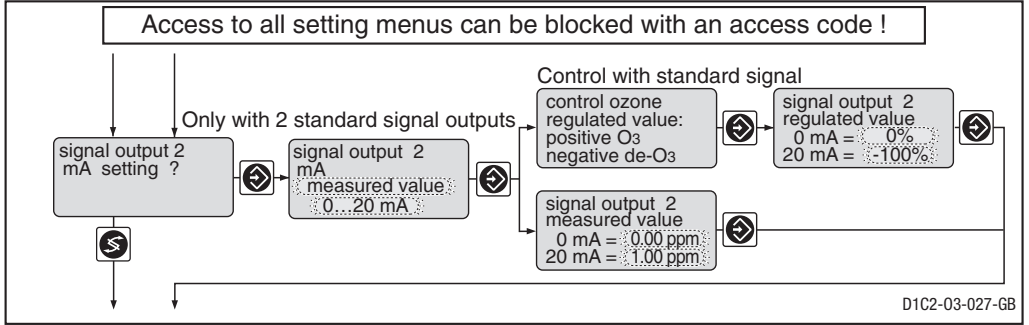

	Initial value	Possible values			Remarks
		Increment	Lower value	Upper value	
Variable allocation	as per identity code	Measured value Controlled variable Correction value			If control applicable only with correction variable Reduction to 3.6 mA when alarm relay switches (not limit value violation) Minimum range 0.1 ppm Minimum range 1 %
Output range	0...20 mA	0...20 mA 4...20 mA 3.6/4-20 mA			
Range measured value	0...5 ppm	0.01 ppm	0 ppm	11.00 ppm	
Range controlled variable	0 %...100 %	1 %	-100 %	+100 %	

General setting

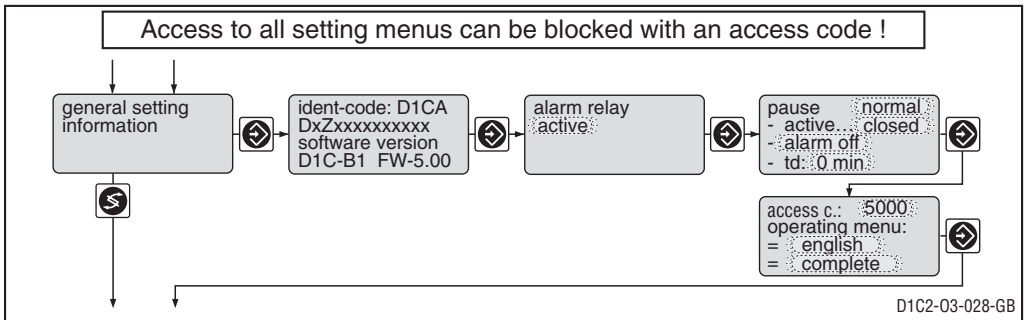

Complete Operating Menu / Description

	Initial value	Possible values			Remarks
		Increment	Lower value	Upper value	
Alarm relay	active	active not active			Alarm relay can be triggered by pause contact
Pause	Normal	Normal Hold			
Control input pause	active closed	active closed active open			
Alarm Pause	Alarm off	Alarm off Alarm on			
td	0 min	1 min	0 min	60 min	
Access code	5000	1	1	9999	
Language	as per identity code	as per identity code			
Operating menu	complete	restricted complete			

Pause Normal

If the pause-switch is off, the DULCOMETER® D1C sets the operating outputs to “0” for as long as the pause-switch is off or for a set time-delay t_d (if t_d is set to > 0 min). Whilst the pause-switch is off, the D1C establishes the P-proportion in the background.

With PID-control (Identity code characteristics “control characteristic” = 2): the I-proportion is stored when the pause is switched off (I-proportion then usually only present if $Ti > 0$ has been selected in the “Control setting?” setting menu).

Exception: the standard signal outputs mA for the measured value or correction value are not affected by the pause.

After pause is activated the operating outputs remain at “0” for the length of the time-delay t_d . The time-delay t_d must be set up in such a way that, in this time e.g. sample water (process-specific current concentration) flows to the sensor.

With PID-control (Identity code characteristics “control characteristic” = 2): The control variable output resulting from the pause and the expiry of the time-delay t_d is reconciled jointly with the current P-component and (if Ti is set > 0) with the stored I-component.

Pause Hold

If the pause-switch is off, the DULCOMETER® D1C freezes the operating output at the most recent value for as long as the pause-switch is off or for a set time-delay t_d (if t_d is set to > 0 min). Whilst the pause-switch is off, the D1C establishes the P-proportion in the background.

With PID-control (Identity code characteristics “control characteristic” = 2):

Even the mA standard signal outputs for measured value or correction value are frozen.

After pause is activated the operating outputs remain frozen for the length of the time delay t_d . The time delay t_d must be set up in such a way that, in this time e.g. sample water (process-specific current concentration) flows to the sensor.

With PID-control (Identity code characteristics “control characteristic” = 2): The control variable output resulting from the pause and the expiry of the time-delay t_d is reconciled jointly with the current P-proportion and (if Ti is set > 0) with the newly established I-proportion.

Access Code

Access to the setting menu can be prevented by setting up an access code. The DULCOMETER® D1C controller is supplied with the access code 5000 which permits free access to the setting menu. The calibration menu remains freely accessible even when access to the setting menu is blocked by the code.

9 Faults / Remarks / Troubleshooting

Fault	Fault text	Symbol	Effect on metering	Effect on control	Alarm with acknowledgement	Remarks	Remedy
Measured value exceeded Checkout time measured value exceeded	Check O_3 probe	E	Basic load	Stop	Yes	Function defeatable	Check function of probe, extend check time
Calibration probe with error	Check O_3 calibration	E	Basic load	Stop	No	Metering continues in case of error with unsteady measured values	Check probe, replace if necessary, recalibrate if necessary
Feed forward control Signal exceeded/drops below value	Check feed forward input	E	Basic load	Stop	Yes	Signal <4.0 ±0.2 mA or >23 ±0.2 mA Value last valid is used	Check probe, transducer and cable connection
Servomotor Electronics error Position not reached	Servomotor defective System error	E O	Stop	Stop	Yes	Servomotor closes Elektronik data defective	Check servomotor Call in service
Pause contact	Pause/Hold	E O	Stop	Stop	No/Yes*	No further fault check	-
During calibration	Probe slope too low Probe slope too high	E	Basic load	Stop	No	No error processing of measured variable	-
During servomotor setting	Position feed back wrong Upper position <40 % max. value Lower position >30 % range	E	Basic load	Stop	No	Without correct adjustment the last valid values are still used	Check connection of relay, potentiometer. Adjust the operation region of the servomotor correctly

*depending on whether "Alarm on" or "Alarm off" set in "General settings"