



Operating Instructions

DULCOMETER® D1C

Part 2: Adjustment and Operation

Measured variable inductive conductivity

D1C2-cond.-001-D



Type D

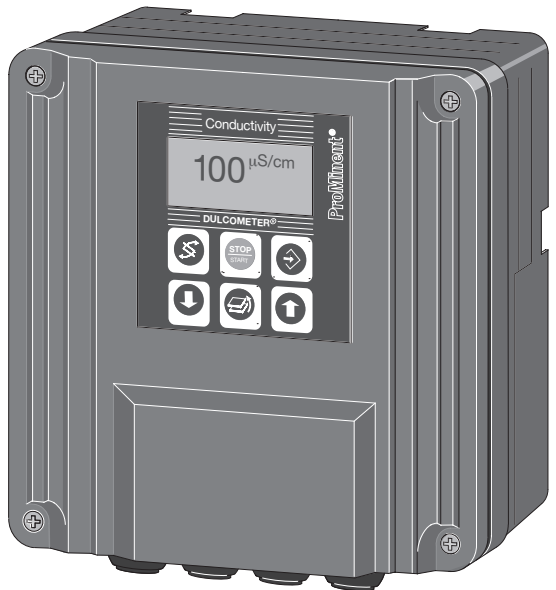

Type W

D1C A

Please enter the identity code of your device here.

**Please completely read through the operating instructions! · Do not discard!
The operator shall be liable for any damage caused
by installation or operating errors!**

2 General User Information

	Page
1 Device Identification / Identity Code	2
2 General User Information	3
3 Device Overview / Controls	4
4 Functional Description	5
5 Display Symbols	6
6 Operation diagram	7
7 Restricted Operating Menu	8
General Layout	8
Description	9
8 Complete Operating Menu	13
Overview	13
Description	14
9 Fault/Remarks/Troubleshooting	28

General User Information

These operating instructions describe the technical data and function of the series DULCOMETER® D1C controller, provide detailed safety information and are divided into clear steps.



IMPORTANT



- ***Please observe the parts of these operating instructions applicable to your particular version! This is indicated in the Section “Device Identification / Identity Code”!***
- ***Correct measuring and metering is only possible in the case of impeccable operation of the sensor. The sensor has to be calibrated / checked regularly!***

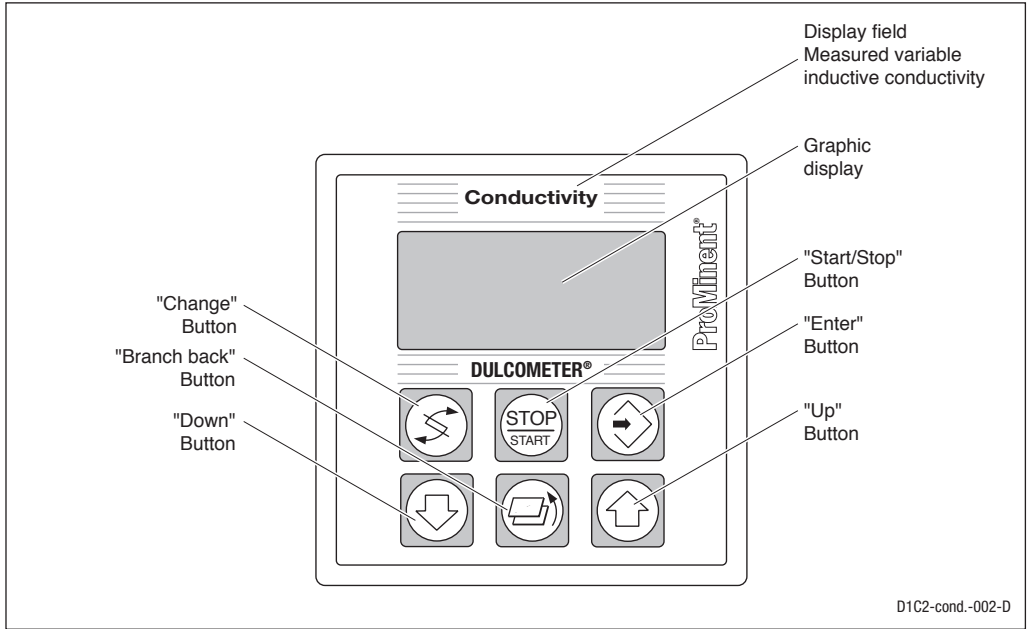

NOTE

A form “Documentation of controller settings type D1C” is available under www.prominent.com/documentation_D1C for the purpose of documenting the controller settings.

3 Device Overview / Controls



	<p>CHANGE Button</p> <p>To change over within a menu level and to change from one variable to another within a menu point.</p>
	<p>START/STOP Button</p> <p>Start/stop of control and metering function.</p>
	<p>ENTER Button</p> <p>To accept, confirm or save a displayed value or status. For alarm acknowledgement.</p>

	<p>UP Button</p> <p>To increase a displayed numerical value and to change variables (flashing display).</p>
	<p>BRANCH BACK Button</p> <p>Back to permanent display or to start of relevant setting menu.</p>
	<p>DOWN Button</p> <p>To decrease a displayed numerical value and to change variables (flashing display).</p>

4 Functional Description

NOTE

Please refer to the description of the complete operating menu in Section 8 for a detailed description of the individual characteristics of the DULCOMETER® D1C controller!

4.1 Operating Menu

The DULCOMETER® D1C controller permits settings to be made in two different menus. All values are preset and can be changed in the **complete operating menu**.

The controller is delivered with a **restricted operating menu** so that the D1C controller can be used effectively in many applications from the very onset. If adaptations prove to be necessary, all relevant parameters can then be accessed by switching over to the complete operating menu (see "General settings").

4.2 Access Code

Access to the setting menu can be prevented by setting up an access code. The D1C controller is supplied with the access code 5000 which permits free access to the setting menu. The calibration menu remains freely accessible even if access to the setting menu is blocked by the code.

4.3 Control

The D1C can operate as a proportional controller or as a PID controller - depending on the device version (see identity code) and the setting.

The controlled variable is recalculated once a second. Control procedures which require rapid correction of setpoint deviations (less than approx. 30 seconds) cannot be processed with this controller. The cycle times must be taken into consideration when activating solenoid valves (pulse length) in the same way as their running times when activating servomotors (3-point).

Via the control input pause, the control function (selection of controlled variable) can be switched off. The calculation of the controlled variable starts again after cessation of "pause".

4.4 Feed Forward Control

The D1C controller can process a signal of a feed forward control. Depending on the device version (see identity code) and the setting, this signal can be obtained in any form of a 0–20 mA or 4–20 mA signal or as a digital contact signal with the maximum frequencies 10 Hz or 500 Hz.

This signal can be used, for example, for flow-proportional metering (multiplicative effect) or feed forward-dependent basic load metering (additive effect). The result of control variable calculation from the proportional or PID control is multiplied by or added to the feed forward signal. A multiplicative feed forward variable at the level of the set rated value carries over the calculated control variable unchanged into the controlled variable:

$$\text{Controlled variable} = \text{Feed forward variable/rated value} \times \text{calculated control variable}$$

During start-up, the zero point has to be checked. The multiplicative feed forward control is not designed for switching off permanently the actuating variable (signal ≈ 0).

An additive feed forward variable at the level of the rated value results in maximum controlled variable:

$$\text{Controlled variable (max. 100 \%)} = \text{Feed forward variable/rated value} \times \text{max. controlled variable} + \text{calculated control variable}$$

4.5 Error Messages

Error messages and information are indicated on the bottom line in the permanent display 1. Errors to be acknowledged (acknowledgement switches off the alarm relay) are indicated by the "E". Errors/notes which still apply after acknowledgement are indicated alternately. During correction variable processing (temperature for correction of pH-value), the value is indicated in the same line as the error/note. Faults which are rectified of their own accord due to changed operating situations are removed from the permanent display without the need for acknowledgement.

5 Display Symbols

The display of the DULCOMETER® D1C controller uses the following symbols:

Description	Comment	Symbol
Limit value transgression Relay 1 upper	Symbol left	↑
Relay 1 lower	Symbol left	↓
Relay 2 upper	Symbol right	↑
Relay 2 lower	Symbol right	↓
Metering pump 1 (Increase conductivity) Control off	Symbol left	■
Control on	Symbol left	□
Metering pump 2 (Reduce conductivity) Control off	Symbol right	■
Control on	Symbol right	□
Solenoid valve 1 (Increase conductivity) Control off	Symbol left	▲
Control on	Symbol left	△
Solenoid valve 2 (Reduce conductivity) Control off	Symbol right	▲
Control on	Symbol right	△
Servomotor Control, open relay		△ ▲
Control, close relay		▲ △
Without control		▲ ▲
Position feedback	Thickness of bar increases from left to right during opening.	▬
Stop button pressed		O
Manual metering		M
Fault		ε

6 Operation diagram

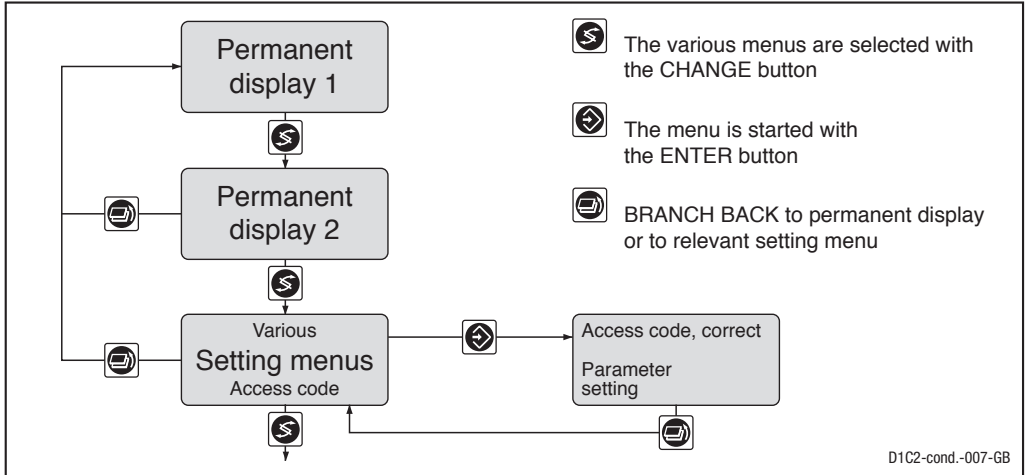

NOTE

Access to the setting menus can be barred with the access code!

The number and scope of setting menus depends on the device version!

If the access code is selected correctly in a setting menu, the following setting menus are also accessible!

If within a period of 10 minutes no button is pushed, the unit automatically branches back from the calibrating menu or a setting menu to the permanent display 1!

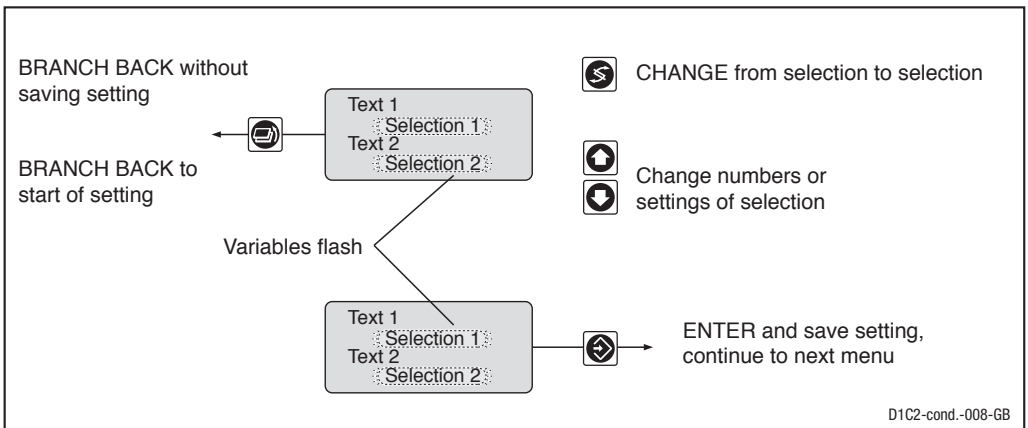

7 Restricted Operating Menu / General Layout

The restricted operating menu permits simple operation of the most important parameters. The following overview shows the settings which can be selected:

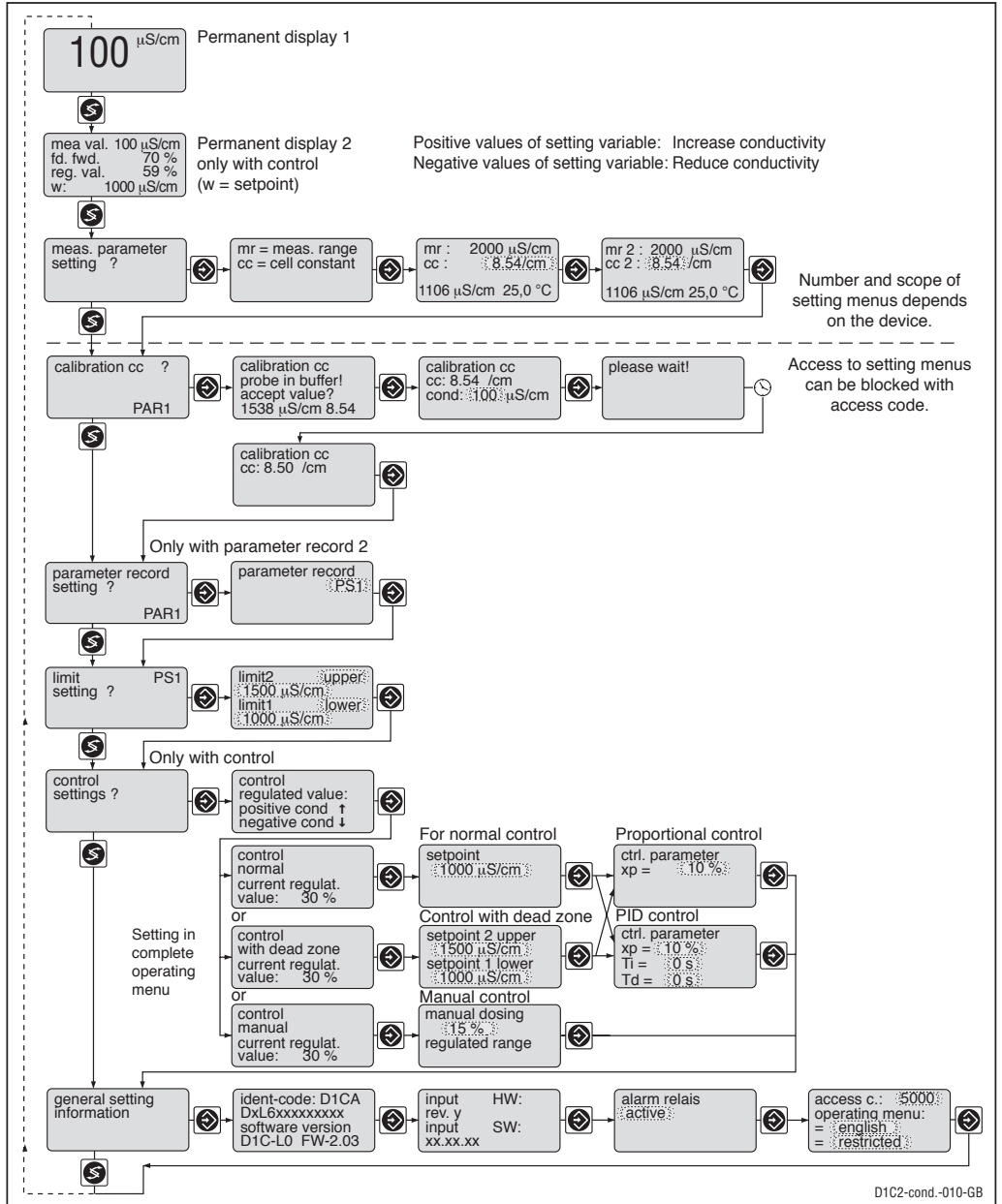

Restricted Operating Menu / Description

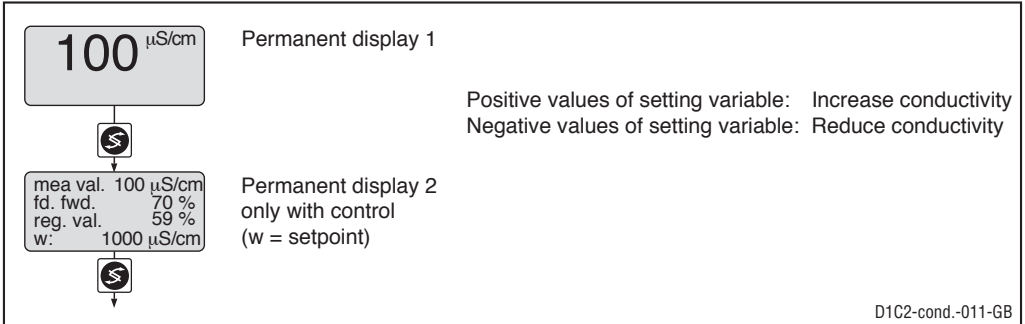

Conductivity calibration

Measurement parameters

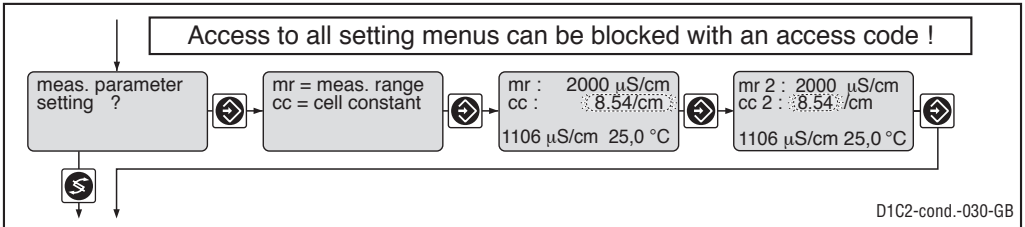

	Initial value	Possible values			Remarks
		Increment	Lower value	Upper value	
Cell constant cc	depending on sensor type used	0.0001/cm 0.001/cm 0.01/cm	0.0060/cm 0.150/cm 1.50/cm	0.1499/cm 1.499/cm 12.00/cm	cc can be adjusted for all mr over the complete area

The measured value can be calibrated by changing the cell constant to the actual conductivity value (arrow keys).

Cell constant calibration (cc)

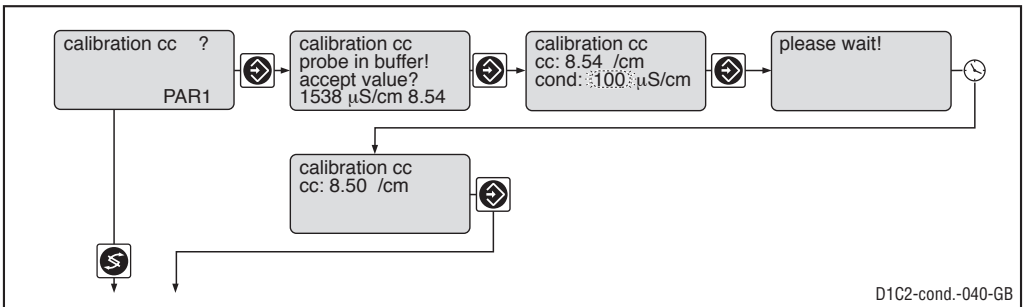

Restricted Operating Menu / Description

To determine the precise cell constant (cc) of the sensor, place the sensor in a calibration solution (sample 1) with a known conductivity and select the second menu option. The DULCOMETER® D1C displays the conductivity it has calculated with the updated parameters. Press Enter when the value is constant.

Select the next menu option and enter the conductivity of the calibration solution (arrow keys). Press Enter. The D1C displays the recalculated cell constant and saves the value.

The setting menu is inactive when "PAR2" appears.

During the calibration, the metering is reduced to the set basic load and control stops.

The limit value monitor and the fault diagnosis system are reset. The standard signal of the "measured value" output is frozen.

	Initial value	Possible values			Remarks
		Increment	Lower value	Upper value	
Conductivity Calibration solution (LF)	Measured value	0.1 µS/cm	0 µS/cm	200 µS/cm	Measuring range 200 µS/cm
		1 µS/cm	0 µS/cm	2000 µS/cm	Measuring range 2000 µS/cm
		0.01 mS/cm	0 µS/cm	20 mS/cm	Measuring range 20 mS/cm
		0.1 mS/cm	0 µS/cm	200 mS/cm	Measuring range 200 mS/cm
		1 mS/cm	0 µS/cm	2000 mS/cm	Measuring range 2000 µS/cm

Parameter record

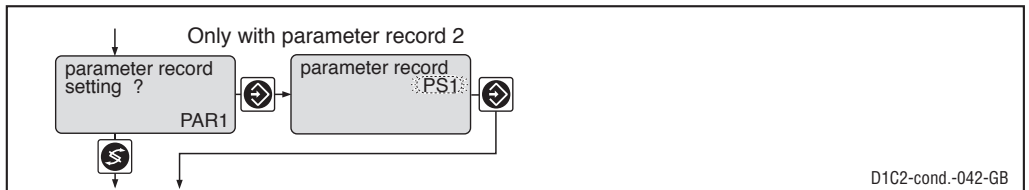

	Initial value	Possible values			Remarks
		Increment	Lower value	Upper value	
Parameter record	PS1	PS1 PS2			

This setting menu can be used to temporarily enable additional parameters of the second parameter record PAR2 to be edited (in addition to the parameters from the setting menu "measurement parameter setting?"). I.e. the "limit setting?" and "mA output 1 (2) setting?" setting menus are enabled to allow editing of PAR2 (designation PS2) until you exit the series of setting menus from "parameter record" to "general setting".

It is possible to switch between the parameter records for operation using the "feed forward control" contact input, e.g. during a flushing process (contact open = PAR1, contact closed = PAR2). When switching between the parameter records, the current parameter record in the setting menu "measurement parameter setting?", "limit setting?" and "mA output 1 (2) setting" is replaced by the other parameter record (designation PS1 or PS2).

There is no access to the calibration menus in the case of PAR2 (designation PS2).

NOTE

- **The designation PAR1 indicates that the parameter record 1 is actively measuring (contact input "feed forward control" e.g. open).**

The designation PS1 indicates that the parameter record 1 can be edited.

Exception: The parameter record 1 cannot be edited while it is actively measuring (designation PAR1). If your controller switches the D1C to parameter set 1 while it is being edited, the D1C returns to the permanent display.

- **PAR2, no control, no standard signal outputs.**

Restricted Operating Menu / Description

Limit values

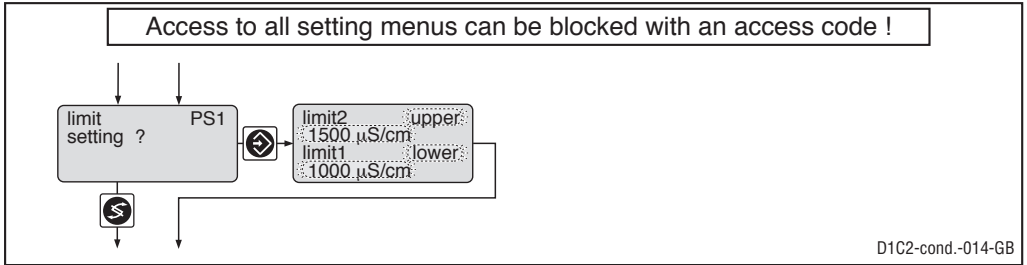

		Initial value	Possible values Increment	Lower value	Upper value	Remarks
Type of limit transgression	Limit 1: Limit 2:	lower upper	lower upper off*			Limit transgression when exceeding or dropping below value *only with limit value relay
Limit value	Limit 1:	100 µS/cm	0.1 µS/cm	-10 µS/cm	210 µS/cm	Measuring range 200 µS/cm
	Limit 2:	150 mS/cm				
	Limit 1:	1000 µS/cm	1 µS/cm	-100 µS/cm	2100 µS/cm	Measuring range 2000 µS/cm
	Limit 2:	1500 µS/cm				
	Limit 1:	10 mS/cm	0.01 mS/cm	-1 mS/cm	21 mS/cm	Measuring range 20 mS/cm
	Limit 2:	15 mS/cm				
	Limit 1:	100 mS/cm	0.1 mS/cm	-10 mS/cm	210 mS/cm	Measuring range 200 mS/cm
	Limit 2:	150 mS/cm				
	Limit 1:	1000 mS/cm	1 mS/cm	-100 mS/cm	2100 mS/cm	Measuring range 2000 mS/cm
	Limit 2:	1500 mS/cm				

Control

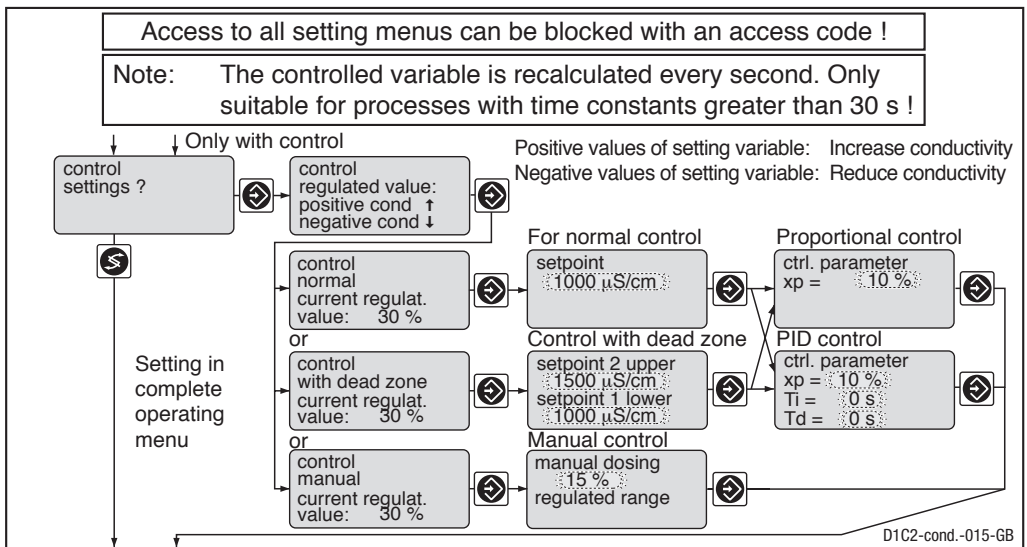

Restricted Operating Menu / Description

	Initial value	Possible values			Remarks
		Increment	Lower value	Upper value	
Setpoint	100 $\mu\text{S/cm}$ 1000 $\mu\text{S/cm}$ 10 mS/cm 100 mS/cm 1000 mS/cm	0,1 $\mu\text{S/cm}$ 1 $\mu\text{S/cm}$ 0,01 mS/cm 0,1 mS/cm 1 mS/cm	-10 $\mu\text{S/cm}$ -100 $\mu\text{S/cm}$ -1 mS/cm -10 mS/cm -100 mS/cm	210 $\mu\text{S/cm}$ 2100 $\mu\text{S/cm}$ 21 mS/cm 210 mS/cm 2100 mS/cm	Measuring range 200 $\mu\text{S/cm}$ Measuring range 2000 $\mu\text{S/cm}$ Measuring range 20 mS/cm Measuring range 200 mS/cm Measuring range 2000 mS/cm Control with dead zone 2 setpoints necessary Setpoint 2 \geq Setpoint 1 Adjustment of measuring range on page 14
Control parameter xp	10 %	1 %	1 %	500 %	xp referred to measuring range
Control parameter Ti	off	1 s	1 s	9999 s	Function off = 0 s
Control parameter Td	off	1 s	1 s	2500 s	Function off = 0 s
Manual metering	0 %	1 %	-100 %	+100 %	

Abbreviations for control variables:

xp: 100 %/Kp (inverse proportional coefficient)

T_i: Integration time of I-controller (s)

T_d: Differential time of D-controller (s)

General settings

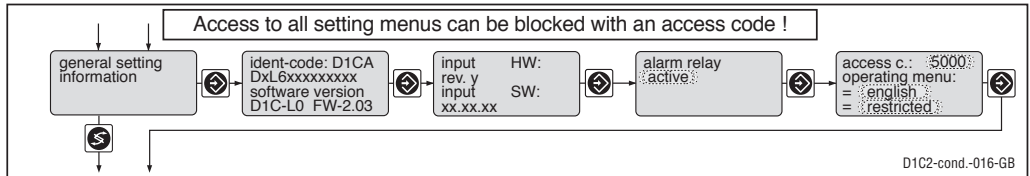

	Initial value	Possible values			Remarks
		Increment	Lower value	Upper value	
Alarm relay	active	active not active			
Access code	5000	1	1	9999	
Language	as per identity code	as per identity code			
Operating menu	restricted	restricted complete			

Access Code

Access to the setting menu can be prevented by setting up an access code. The D1C controller is supplied with the access code 5000 which permits free access to the setting menu. The calibration menu remains freely accessible even if access to the setting menu is blocked by the code.

8 Complete Operating Menu / Overview

All parameters of the controller can be set in the complete operating menu (see previous page). The following overview shows the settings which can be selected:

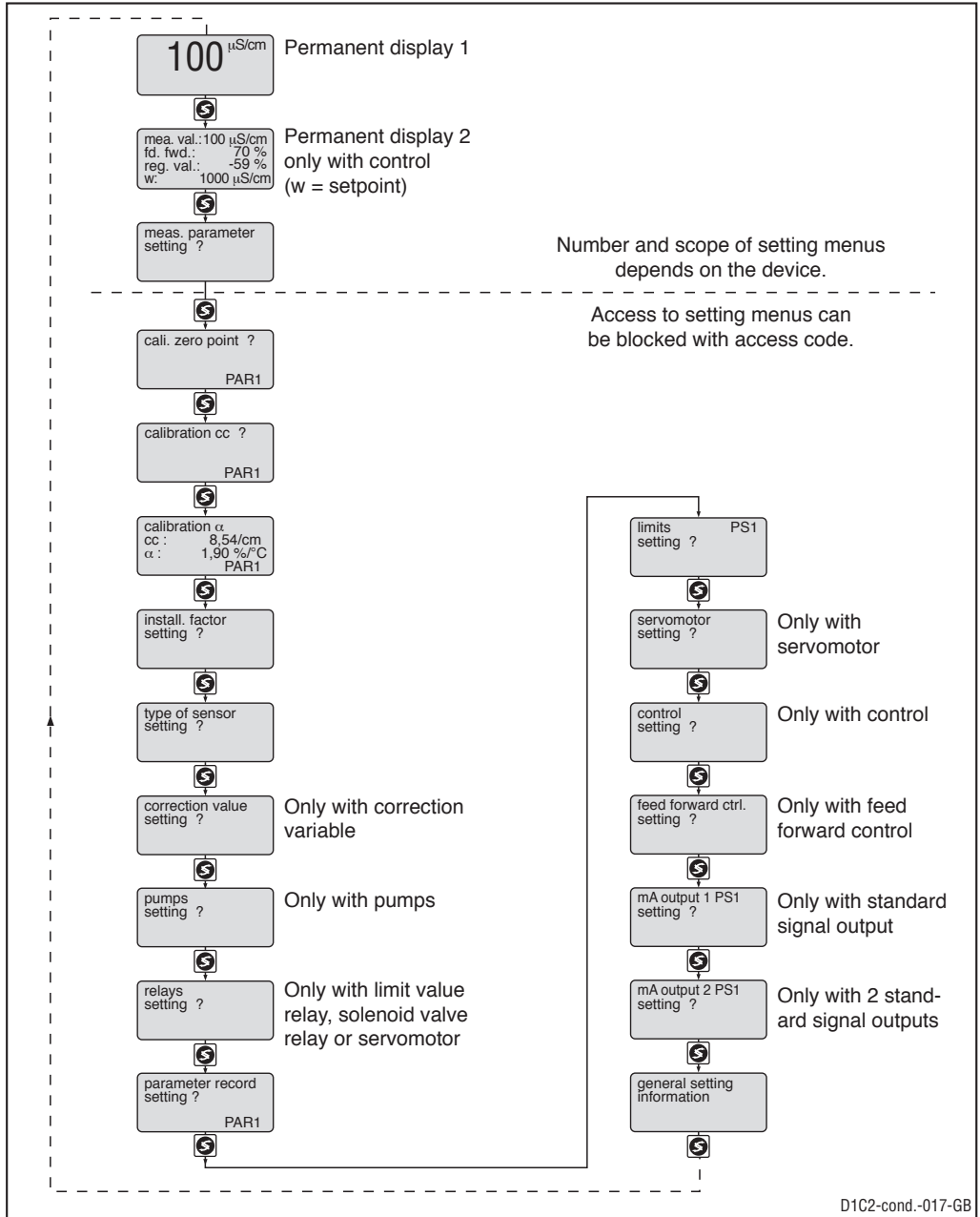

Complete Operating Menu / Description

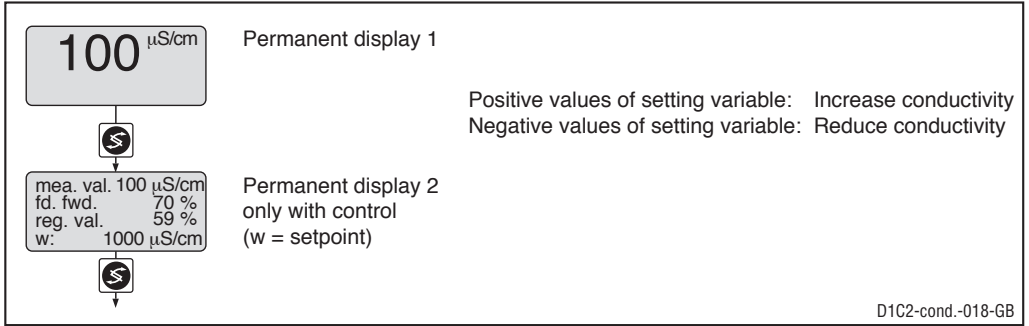

Measuring parameter

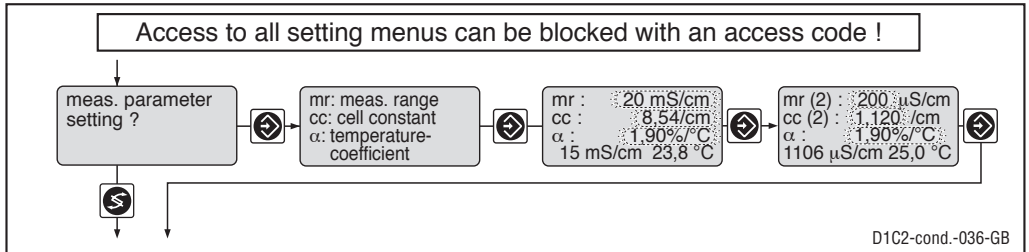

	Initial value	Possible values			Remarks
		Increment	Lower value	Upper value	
Measuring ranges mr	0....2000 µS/cm	0....200 µS/cm 0....2000 µS/cm 0....20 mS/cm 0....200 mS/cm 0....2000 mS/cm			At mr 2: 0 = off (parameter record switching) Setpoint- and limit values are switched to the associated initial values
Cell constant cc	depending on the sensor type used	0.0001/cm 0.001/cm 0.01/cm	0.0060/cm 0.150/cm 1.50/cm	0.1499/cm 1.499/cm 12.00/cm	cc can be adjusted for all mr over the complete area
Temperature coefficient α	1.90 %/°C	0.01 %/°C	0 %/°C	10 %/°C	

The measured value can be compensated for by changing the cell constant to the actual conductivity value (arrow keys!). The precondition is a known temperature coefficient and constant temperature.

Metering and control stops if the measurement range is changed.

Setpoints, limit values and standard signal outputs are switched to the associated starting values. Check the settings in all menus.

The parameter sets are described on page 21.

Complete Operating Menu / Description

Calibration of zero point (zp)

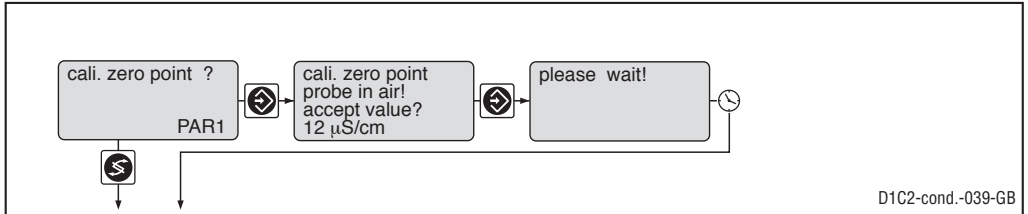

To determine the precise zero point (zp) of the sensor, hold the sensor in the air and select the second menu option. The DULCOMETER® D1C displays the conductivity without zero point correction. Press Enter when the value is constant.

The setting menu is inactive when “PAR2” appears.

During the calibration, the metering is reduced to the set basic load and control stops. The limit value monitor and the fault diagnosis system are reset. The standard signal of the “measured value” output is frozen.

Cell constant calibration (cc)

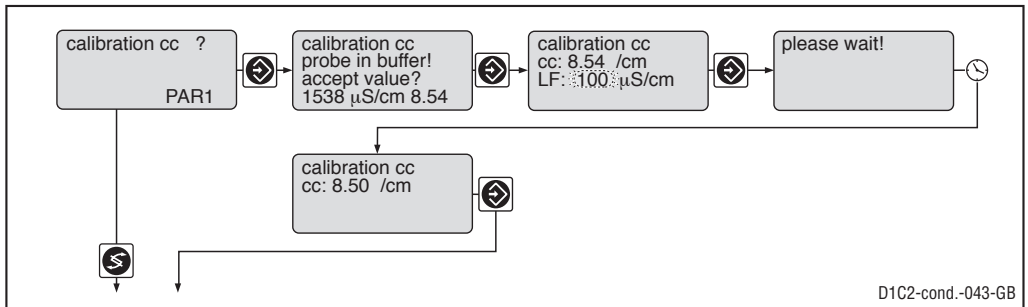

To determine the precise cell constant (cc) of the sensor, place the sensor in a calibration solution (sample 1) with a known conductivity and select the second menu option. The DULCOMETER® D1C displays the conductivity which it has calculated with the current parameters. Press Enter when the value is constant.

Select the next menu option and enter the conductivity of the calibration solution (arrow keys). Press Enter. The D1C displays the recalculated cell constant and saves the value.

The setting menu is inactive when “PAR2” appears.

During the calibration, the metering is reduced to the set basic load and control stops. The limit value monitor and the fault diagnosis system are reset. The standard signal of the “measured value” output is frozen.

	Initial value	Possible values			Remarks
		Increment	Lower value	Upper value	
Conductivity Calibration solution (LF)	Measured value	0.1 µS/cm	0 µS/cm	200 µS/cm	Measuring range 200 µS/cm
		1 µS/cm	0 µS/cm	2000 µS/cm	Measuring range 2000 µS/cm
		0.01 mS/cm	0 µS/cm	20 mS/cm	Measuring range 20 mS/cm
		0.1 mS/cm	0 µS/cm	200 mS/cm	Measuring range 200 mS/cm
		1 mS/cm	0 µS/cm	2000 mS/cm	Measuring range 2000 µS/cm

Complete Operating Menu / Description

Calibration of temperature coefficient α

The temperature coefficient α is determined again by means of a two point calibration. During the calibration, the metering is reduced to the set basic load and control stops. The limit value monitor and the fault diagnosis system are reset. The standard signal of the measured value or correction value output is reduced to 0/4 mA.



IMPORTANT

Only values determined at 25 °C may be entered as conductivity values. The calibration must be carried out with the same solution at both temperatures.

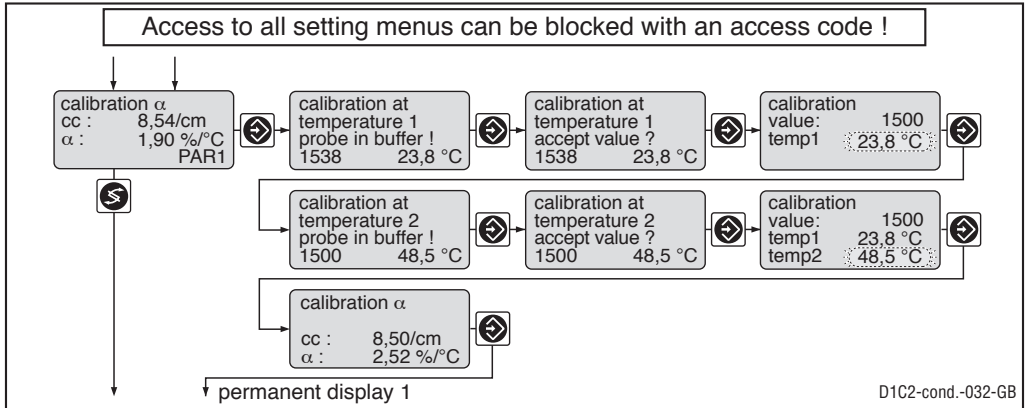

	Initial value	Possible values			Remarks
		Increment	Lower value	Upper value	
Set temperature	Correction value	0.1 °C	0 °C	100 °C	

Error message/Warning	Condition	Remarks
Temperature range restricted xx - 100 °C		For the chosen temperature coefficient α , a correct reading can only be obtained for the displayed temperature range
Temperature interval incorrect	Δ temperature ≥ 10.0 °C Δ temperature ≤ 50.0 °C	

Installation factor setting

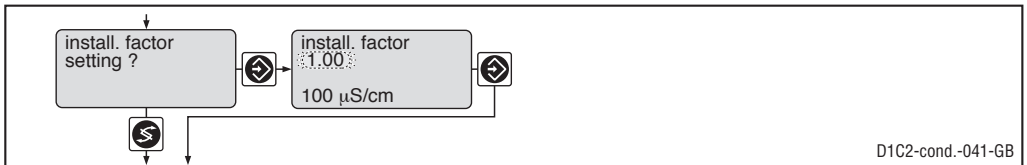

	Initial value	Possible values			Remarks
		Increment	Lower value	Upper value	
Installation factor	1.00	0.01	0.01	9.99	

Complete Operating Menu / Description

Enter the installation factor of the installed sensor here (arrow keys!). Determine the installation factor using the data from the sensor documentation and the installation geometry.

Type of sensor setting

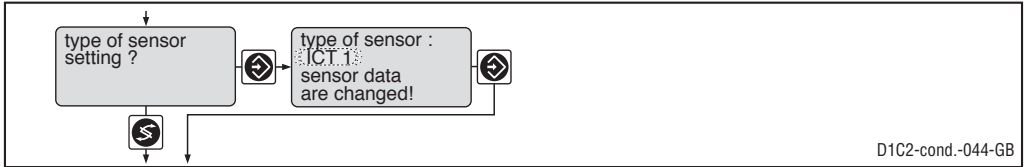

	Initial value	Possible values			Remarks
		Increment	Lower value	Upper value	
Type of sensor	ICT 1	ICT 1 ICT 1-IMA ICT 2 / CLS50 ICT 3 / CLS52			The default actuation parameters are loaded

When changing the sensor, press Enter to load the actuation parameters permanently stored in DULCOMETER® D1C for this sensor type. Metering and control stop and the measured value-specific error messages are deleted.



IMPORTANT

- **The limit values, the setpoints and the standard signal outputs are set to the default values.**
- **Check the settings in all menus!**

Correction value

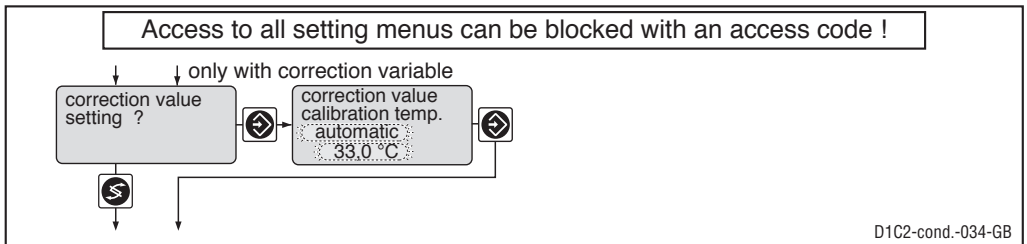

	Initial value	Possible values			Remarks
		Increment	Lower value	Upper value	
Type of temperature compensation	as per identity code	manual automatic off			
Manual temperature	25 °C	0.1 °C	-199.9 °C	199.9 °C	
Automatic temperature	Correction value	0.1 °C	-5.0 °C	5.0 °C	by the temperature measured value

Complete Operating Menu / Description

Pumps

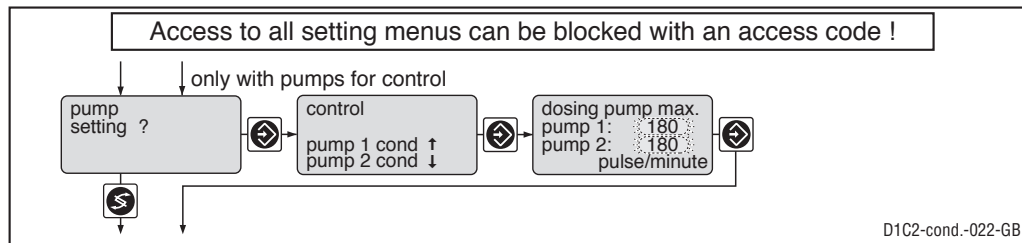

	Initial value	Possible values			Remarks
		Increment	Lower value	Upper value	
Max. stroke/minute of pumps 1 and 2	180	1	1	500	off = 0 strokes/min

Relay for power control

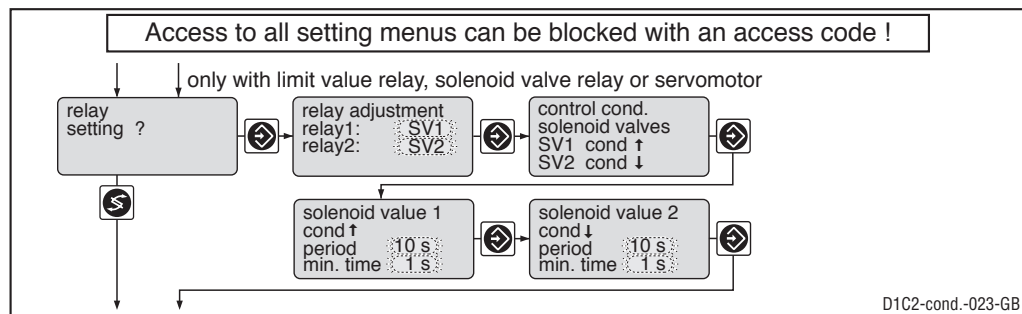

	Initial value	Possible values			Remarks
		Increment	Lower value	Upper value	
Relay adjustment	as per identity code	Motor Solenoid valve (SV1, SV2) Limit value (Limit 1/2) Actuator 1,2 Servomotor			*At "limit value" the relays remain active even with a fault.
Cycle	10 s	off	10 s	9999 s	for solenoid valve
min. time	1 s	1 s	1 s	cycle/2	for solenoid valve

NOTE

The limit value relays can also be defined such that they react like an actuator. If e.g. a limit value relay picked up, it will drop at a closed pause contact or for a subsequent delay time t_d (if $t_d > 0$ min is set in "General settings").

Complete Operating Menu / Description

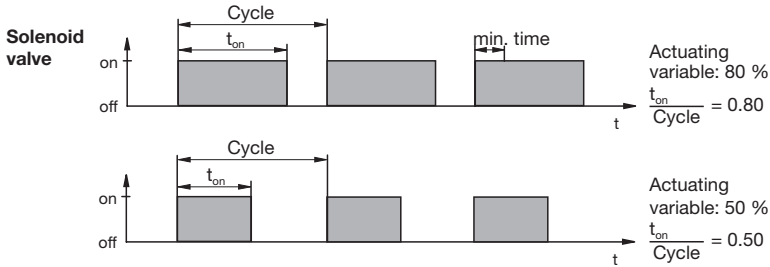

The switching time of the DULCOMETER® D1C (solenoid valve) depends on the actuating variable and the “min. time“ (smallest permitted operating factor of the connected device).

The actuating variable determines the ratio $t_{on}/cycle$ and thus the switching times (see fig. above). The “min. time“ influences the switching times in two situations:

a) theoretical switching time < min. time:

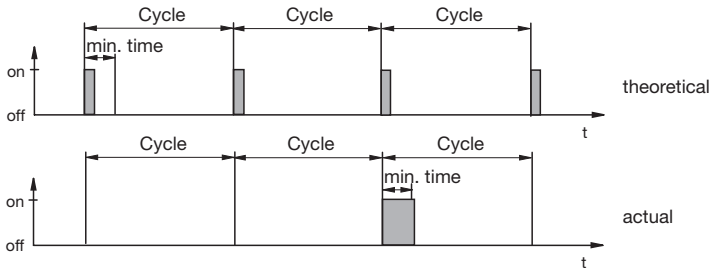

The DULCOMETER® D1C does not switch for a certain number of cycles until the sum of the theoretical switching times exceeds the “min. time“. Then the DULCOMETER® D1C switches for the duration of this total time.

b) theoretical switching time > (cycle - min. time) and calculated switching time < cycle

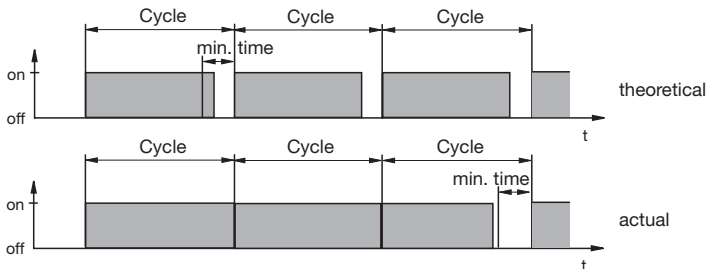

The DULCOMETER® D1C does not deactivate for a certain number of cycles until the differences between cycle and theoretical switching time exceed the “min. time“.

Complete Operating Menu / Description

Parameter record

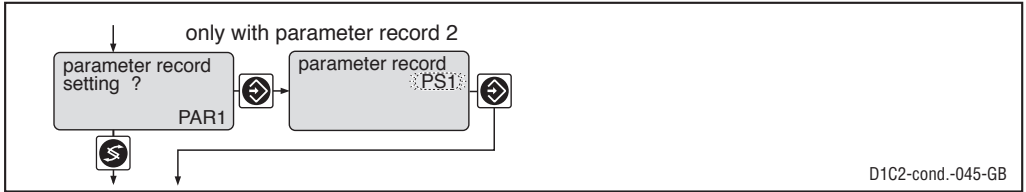

D1C2-cond.-045-GB

	Initial value	Possible values		Remarks
		Increment	Lower value	
Parameter record	PS1	PS1 PS2		

This setting menu can be used to temporarily enable additional parameters of the second parameter record PAR2 to be edited (in addition to the parameters from the setting menu “measurement parameter setting?”). I.e. the “limit value setting” and “mA output 1 (2) setting?” setting menus are enabled to allow editing of PAR2 (designation PS2!) until you exit the series of setting menus from “parameter record” to “general setting”.

It is possible to switch between the parameter records for operation using the “feed forward control” contact input, e.g. during a flushing process (contact open = PAR1, contact closed = PAR2). When switching between the parameter records, the current parameter record in the setting menus “meas. parameter setting?”, “limit setting?” and “mA output 1 (2) setting” is replaced by the other parameter record (designation PS1 or PS2).

There is no access to the calibration menus in the case of PAS2 (designation PS2!).

NOTE

- **The designation PAR1 indicates that the parameter record 1 is actively measuring (contact input “feed forward control” e.g. open).**
The designation PS1 indicates that the parameter record 1 can be edited.
Exception: The parameter record 1 cannot be edited while it is actively measuring (designation PAR1). If your controller switches the D1C to parameter record 1 while it is being edited, the D1C returns to the permanent display.
- **PAR2, no control, no standard signal outputs.**

Complete Operating Menu / Description

Limit values

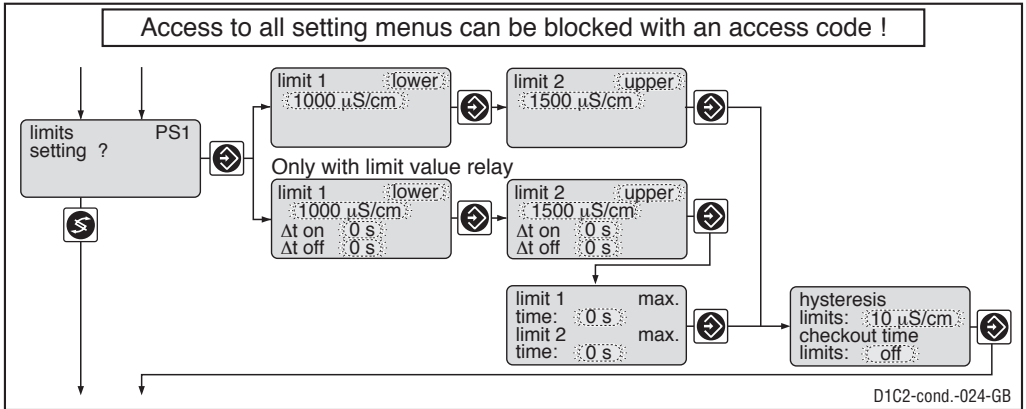

		Possible values			Remarks	
Type of limit transgression	Limit 1 Limit 2	Initial value	Increment	Lower value		Upper value
		lower upper	upper lower off*			Limit transgression when exceeding or dropping below value. *only with limit value relay
	Limit value 1; Limit value 2	0; 2000 mS/cm 0; 200 mS/cm 0; 20 mS/cm 0; 2000 μS/cm 0; 200 μS/cm	1 mS/cm 0.1 mS/cm 0.01 mS/cm 1 μS/cm 0.1 μS/cm	-100 mS/cm -10 mS/cm -1 mS/cm -100 μS/cm -10 μS/cm	2100 mS/cm 210 mS/cm 21 mS/cm 2100 μS/cm 210 μS/cm	Meas. range 2000 mS/cm Meas. range 200 ms/cm Meas. range 20 ms/cm Meas. range 2000 μs/cm Meas. range 200 μs/cm
	Hysteresis limit values	10 mS/cm 1 mS/cm 0.1 mS/cm 10 μS/cm 1.0 μS/cm	1 mS/cm 0.1 mS/cm 0.01 mS/cm 1 μS/cm 0.1 μS/cm	0 mS/cm 0 mS/cm 0 mS/cm 0 μS/cm 0 μS/cm	2100 mS/cm 210 mS/cm 21 mS/cm 2100 μS/cm 210 μS/cm	Effective in direction of "Cancelling limit transgression"
	Checkout time limits t on	off	1 s	1 s/off	9999 s	Results in message and alarm. off = 0 s: Function switched off, no message, no alarm
	Switch-on delay Δ t on	0 s	1 s	0 s	9999 s	Only available in complete operating menu
	Switch-off delay Δ t off	0 s	1 s	0 s	9999 s	Only available in complete operating menu
	Max. switch-on time Limit value 1; Limit value 2	off	1 s	0 s/off	9999 s	Only available in complete operating menu Function switched off

If the limit transgression is longer than the "delay time limit value", an error message is triggered (requires acknowledgement) and the alarm relay opens; if "control" is also set to "off", the control process will stop.

Complete Operating Menu / Description

Servomotor

The **operating range** is given by the overall resistance range of the feedback potentiometer. Defining the control range places a maximum limit on the **control range** used.



IMPORTANT

- The servomotor must be actuated with the same care as for the calibration of a measuring sensor.
- To ensure correct function, the control duration of the servomotor must be at least 25 seconds for 0...100 % of the control range.

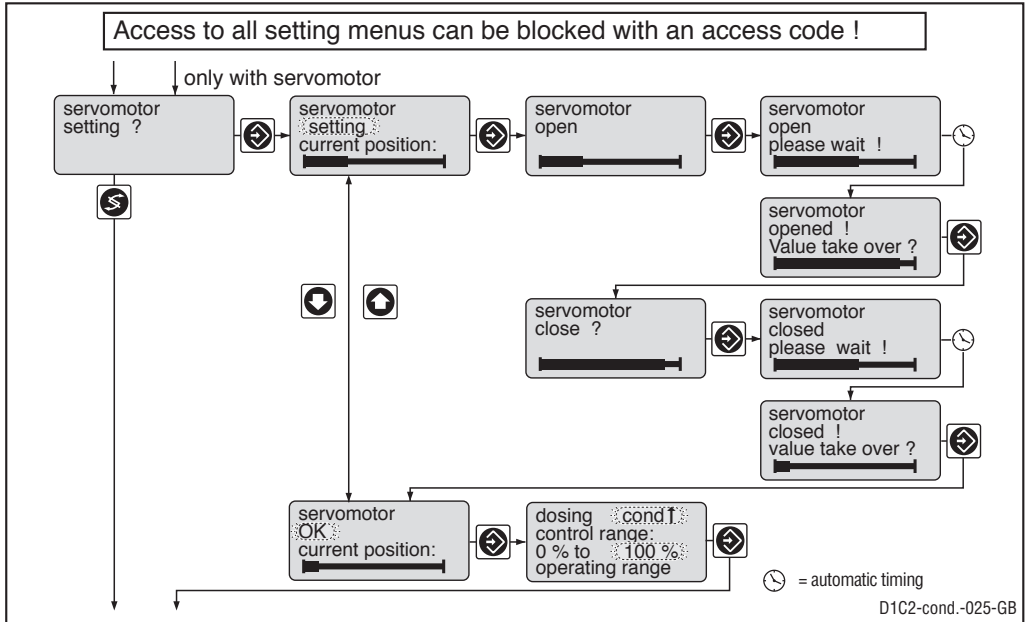

	Initial value	Possible values			Remarks
		Increment	Lower value	Upper value	
Servomotor	Setting	Setting ok off			
Control direction	Cond.↑	Cond.↑ Cond.↓			
Control range	100 %	1 %	10 %	100 %	in % of operating range

NOTE

- When the wide bar is as far right as it will go, the servomotor is fully open.
- The permanent display shows to what degree the motor has opened in % (the greater the percentage, the farther open the servomotor).

Complete Operating Menu / Description

Control

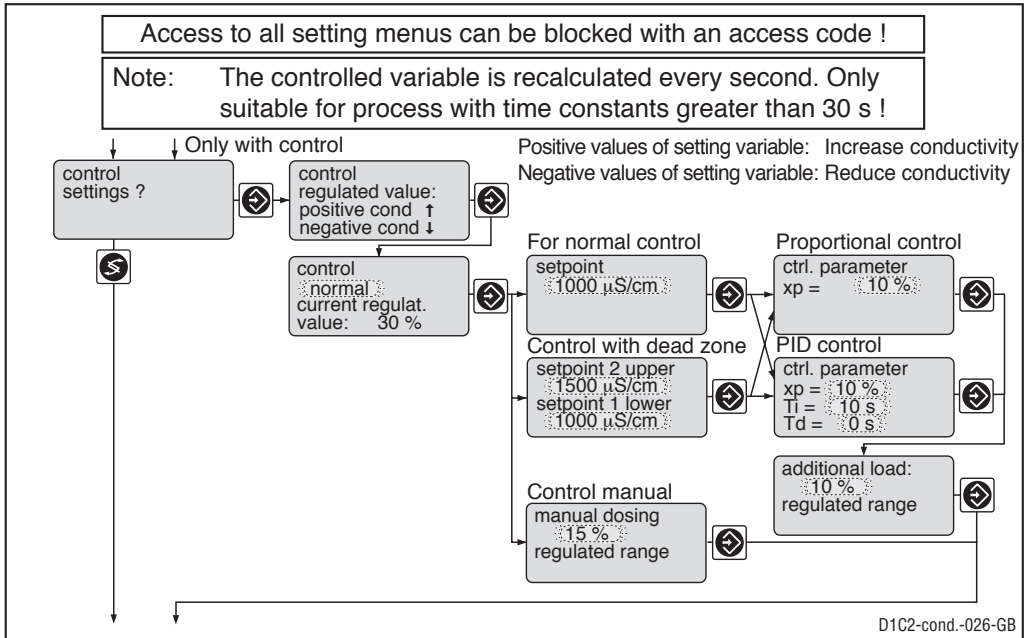

	Initial value	Possible values			Remarks
		Increment	Lower value	Upper value	
Control	normal	normal with dead zone manual			When controlling with dead zone, the regulated value is not used for measured values within the dead zone
Setpoint setting	1000 mS/cm 100 mS/cm 10 mS/cm 1000 µS/cm 100 µS/cm	1 mS/cm 0.1 mS/cm 0.01 mS/cm 1 µS/cm 0.1 µS/cm	-100 mS/cm -10 mS/cm -1 mS/cm -100 µS/cm -10 µS/cm	2100 mS/cm 210 mS/cm 21 mS/cm 2100 µS/cm 210 µS/cm	Measuring range 2000 mS/cm* Measuring range 200 mS/cm Measuring range 20 mS/cm Measuring range 2000 µS/cm Measuring range 200 µS/cm Setpoint 2 ≥ setpoint 1 See page 14 for setting measuring range.
Control parameter xp	10 %	1 %	1 %	500 %	xp referred to measuring range
Control parameter Ti	off	1 s	1 s	9999 s	Function off = 0 s
Control parameter Td	off	1 s	1 s	2500 s	Function off = 0 s
Additional basic load	0 %	1 %	-100 %	+100 %	
Manual metering	0 %	1 %	-100 %	+100 %	

Abbreviations for control variables:

xp: 100 %/Kp (inverse proportional coefficient)

T_i: Integration time of I-controller (s)

T_d: Differential time of D-controller (s)

Complete Operating Menu / Description

Feed forward control

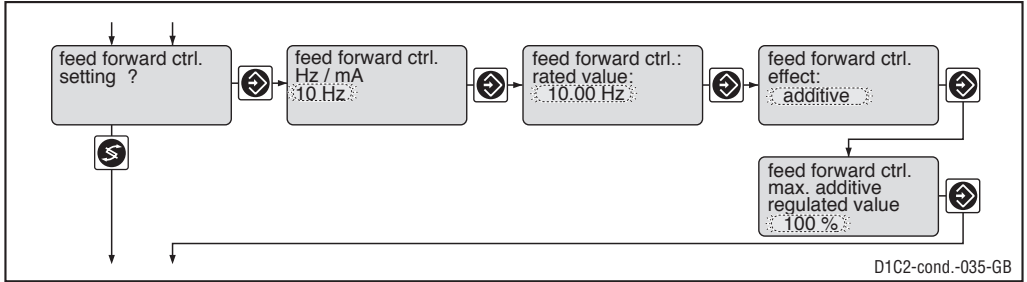

	Initial value	Possible values			Remarks
		Increment	Lower value	Upper value	
Feed forward control (flow)	as per identity code at standard signal	none 10 Hz 500 Hz 0...20 mA 4...20 mA			Signal processing: Signal < 0,2 mA = No flow Signal < 4,2 mA = No flow
Feed forward control rated value	20 mA 10 Hz 500 Hz	0.01 mA 0.01 Hz 1 Hz	0/4 mA 0.1 Hz 5 Hz	20 mA 10 Hz 500 Hz	Depending on signal type. Maximum limitation of range used.
Feed forward control Feed forward effect	multiplicative	multiplicative additive			
Max. additive regulated value	100 %	1 %	-500 %	+500 %	Only with additive regulated value.

Standard signal output 1

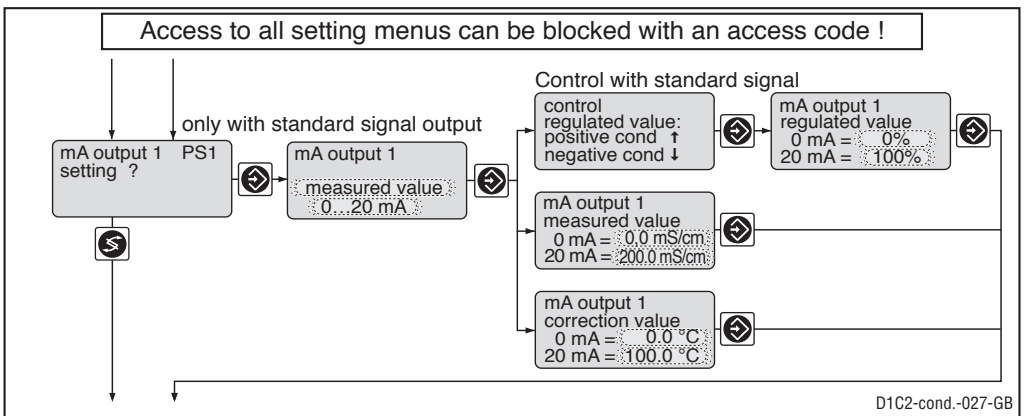

Complete Operating Menu / Description

Standard signal output 2

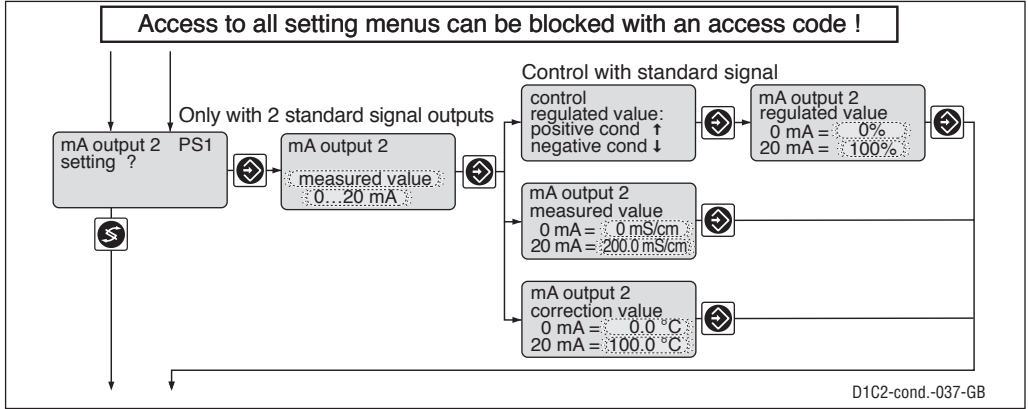

	Initial value	Possible values			Remarks
		Increment	Lower value	Upper value	
Variable allocation	as per identity code	Measured value Controlled variable Correction value off			If control is present
Output range	0...20 mA	0...20 mA 4...20 mA 3.6/4-20 mA			No setting in case of PAR2 Reduction to 3.6 mA when alarm relay switches (not limit value violation)
Range measured value	0-200 µS/cm 0-2000 µS/cm 0-20 mS/cm 0-200 mS/cm 0-2000 mS/cm	0.1 µS/cm 1 µS/cm 0.01 mS/cm 0.1 mS/cm 1 mS/cm	-10 µS/cm -100 µS/cm -1 mS/cm -10 mS/cm -100 mS/cm	210 µS/cm 2100 µS/cm 21 mS/cm 210 mS/cm 2100 mS/cm	at meas. range up to 200 µS/cm at meas. range up to 2000 µS/cm at meas. range up to 20 mS/cm at meas. range up to 200 mS/cm at meas. range up to 2000 mS/cm
Range regulated value	0 %...+100 %	1 %	-100 %	+100 %	Minimum range 1 % No setting in case of PAR2
Range correction variable	0...100,0 °C	0,1 °C	0,0 °C -199,9 °C	100 °C +199,9 °C	Minimum range 1 % No setting in case of PAR2

Complete Operating Menu / Description

General setting

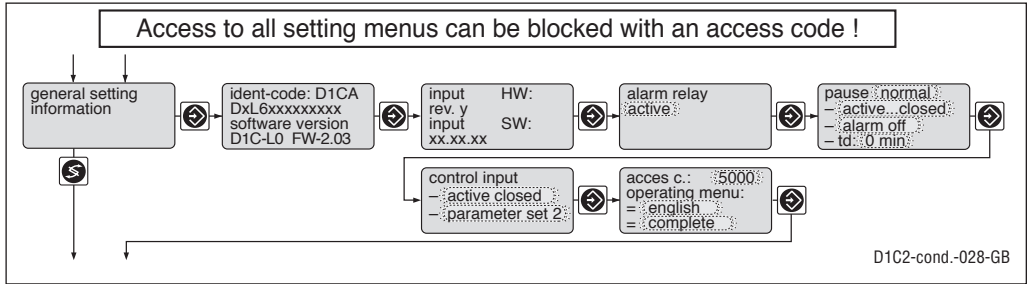

	Initial value	Possible values Increment	Lower value	Upper value	Remarks
Alarm relay	active	active not active			Alarm relay can be activated by pause contact
Pause	normal	normal hold			
Control input pause	active closed	active closed active open			
Alarm pause	Alarm off	Alarm off Alarm on			
Pause Time delay td	0 min	1 min	0 min	60 min	
Input control Input	active closed	active closed active open			Switch status for parameter record 2 Only with parameter record switching
Control input Function	Parameter set 2	Parameter set 2 off			off = parameter set switching off Only with parameter record switching
Access code Language	5000 as per identity code	1 as per identity code	1	9999	
Operating menu	complete	restricted complete			

Complete Operating Menu / Description

Normal pause

If the pause switch is off, the DULCOMETER® D1C sets the operating outputs to “0” for as long as the pause switch is off or for a set time delay t_d (if t_d is set to > 0 min). Whilst the pause switch is off, the DULCOMETER® D1C establishes the P-proportion in the background.

With PID-control (identity code characteristics “control characteristic“ : 2): the I-proportion is stored when the pause is switched off (I-proportion then usually only present if $T_i > 0$ has been selected in the “control setting?“ setting menu).

Exception: the standard signal outputs mA for the measured value or correction value are not affected by the pause.

After pause is activated, the operating outputs remain at “0” for the length of the time delay t_d . The time delay t_d must be set up in such a way that in this time e.g. sample water (process-specific current concentration) flows to the sensor.

With PID-control (identity code characteristics “control characteristic“: 2): The control variable output resulting from the pause and the expiry of the time delay t_d is reconciled jointly with the current P-component and (if T_i is set > 0) with the stored I-component.

Pause hold

If the pause switch is off, the DULCOMETER® D1C freezes the operating output at the most recent value for as long as the pause switch is off or for a set time delay t_d (if t_d is set to > 0 min). Whilst the pause switch is off, the DULCOMETER® D1C establishes the P-proportion in the background.

With PID-control (Identity code characteristics “control characteristic“ : 2):

Even the mA standard signal outputs for measured value or correction value are frozen.

After pause is activated, the operating outputs remain frozen for the length of the time delay t_d . The time delay t_d must be set up in such a way that, in this time e.g. sample water (process-specific current concentration) flows to the sensor.

With PID-control (identity code characteristics “control characteristic“: 2): The control variable output resulting from the pause and the expiry of the time delay t_d is reconciled jointly with the current P-proportion and (if T_i is set > 0) with the newly established I-proportion.

Access Code

Access to the setting menu can be prevented by setting up an access code. The D1C controller is supplied with the access code 5000 which permits free access to the setting menu. The calibration menu remains freely accessible even if access to the setting menu is blocked by the code.

9 Fault / Remarks / Troubleshooting

Error	Fault text	Symbol	Effect on metering	Effect on control	Alarm with acknowledgement	Remarks	Remedy
Measured value Signal exceeded/drops below value*	<i>ms measurement range</i> ↑↓ <i>Check ms input</i>	☹	Basic load	Stop	yes	Measured value outside range	Check measured variable setting Check sensor and cable connection
Checkout time exceeded*	<i>Check ms probe</i>	☹	Basic load	Stop	yes	Function detachable	Check sensor function, extend control time
Correction measured variable Signal exceeded/drops below value	<i>Check Te. input</i> <i>Te. limit value</i> ↓	☹	Basic load	Stop	yes	Signal $-3.8 \pm 0.2 \text{ mA}$ or $>23 \pm 0.2 \text{ mA}$ at $\alpha \geq 4 \text{ }^\circ\text{C}$	Check sensor, transformer and cable connection
Upper Te. limit value exceeded		☹	Basic load	Stop	yes		
Feed forward control Signal exceeded/drops below value	<i>Check feed forward input</i> "	☹		Stop	yes	Signal <math><-3.0 \pm 0.2 \text{ mA}</math> or $>23 \pm 0.2 \text{ mA}$ The last valid value is used	Check sensor, transformer and cable connection
Signal below value, multiplicative		☹		Stop	yes		
Limit value violation after control time	<i>ms-limit 1</i> ↑↑ <i>ms-limit 2</i> ↓↓	☹			yes	Function detachable	Define cause Reset values if necessary
Servomotor position not reached	<i>Servomotor defective</i>	☹			yes	Servomotor closes	Check servomotor
Electronic error	<i>System error</i> <i>LF cable defective, amplifier defective, check SPI</i>	☹	Stop	Stop	yes	Electronic data defective Sensor cable defective	Call customer service Change sensor cable

Operating step	Note text	Symbol	Effect on metering	Effect on control	Alarm with acknowledgement	Comment	Remedy
Pause contact	<i>Pause</i>	☹	Stop	Stop	no/yes*	No further fault check	-
	<i>Pause/Hold</i>	☹		Stop			
Control Input	<i>Parameter set 2</i>	☹	Stop	Stop	no		
	<i>Stop</i>	☹	Stop	Stop	no	Relay drops out	-
Calibration Calibration with error	<i>Check measurement range</i>	☹	Basic load	Stop	-	-	Repeat calibration Check sensor/calibration solution
During servomotor setting Position feedback	<i>Check direction</i>						
Upper position <math><40 \text{ } \% max. value	<i>Final value low</i>					Without correct adjustment, the last valid values are still used	Check potentiometer and relay connection Set correct servomotor operating range
Lower position <math>>30 \text{ } \% range	<i>Final value high</i>						

* depending on whether "Alarm on" or "Alarm off" set in "General settings".