

Operating Instructions

DULCOMETER® D2C

Part 2: Adjustment and Operation,
Measured Variables pH/pH

D2C2-001-pH/pH-GB

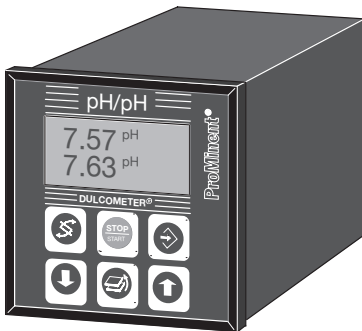

Type D

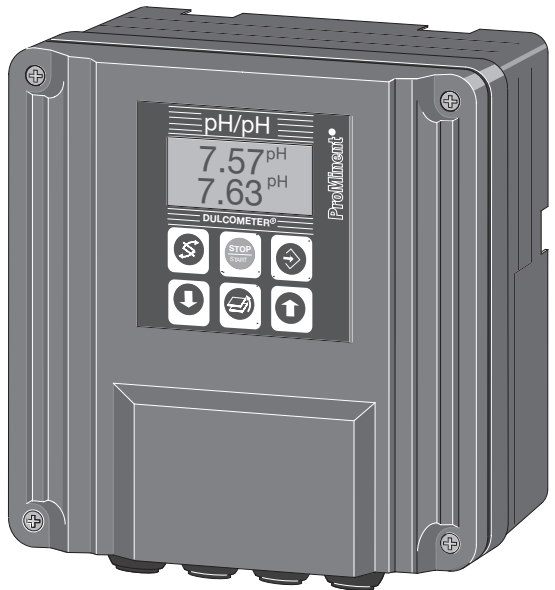

Type W

D2C A _____

Please enter the identity code of your device here!

**Please completely read through the operating instructions! · Do not discard!
The warranty shall be invalidated by damage caused by operating errors!**

1 Device Identification / Identity Code

D2C A	DULCOMETER® Controller Series D2C	
	W	Wall mounting
	D	Panel mounting
		Operating voltage
	0	230 V 50/60 Hz
	1	115 V 50/60 Hz
	4	24 V AC/DC
		Measured variable 1 / Measured variable 2
	PP	pH (0-14 pH) / pH (0-14 pH)
		Connection of measured variable 1 (connection measured variable 2: 4-20 mA)
	1	Terminal standard signal 4-20 mA (signal converters are necessary)
	2	SN6 plug connector
	5	Terminal mV
		Correction variable
	0	None
	2	Temperature for P, via terminal (Pt 100), pH only
	4	Manual temperature input for P, pH only
		Disturbance variable connection
	0	None
		Signal output
	0	None
	4	2 Standard signal 0/4-20 mA outputs, free programmable
		Power control
	G	Alarm and 2 limit relays
	M	Alarm and 2 solenoid valve relays (Pulse length control)
		Control characteristic
	1	Proportional control
	2	PID control
		Protocol output
	0	None
		Language
	D	German
	E	English
	F	French
	S	Spanish
	A	Swedish
	N	Dutch
D2C A	_____	

Please enter the identity code of your device here!

2 General User Information

	Page
1 Device Identification / Identity Code	2
2 General User Information	3
3 Device Overview / Controls	4
4 Functional Description	5
5 Display Symbols	6
6 Operation diagram	7
7 Operation Menu / Overview	8
8 Operation Menu / Description	12
9 Technical Terms	22
10 Faults / Notes / Troubleshooting	24

General User Information

These operating instructions describe the technical data and function of the series DULCOMETER® D2C controller, provide detailed safety information and are divided into clear steps.



IMPORTANT

- *Please observe the parts of these operating instructions applicable to your particular version! This is indicated in the Section “Device Identification / Identity Code”.*
- *Correct measuring and metering is only possible in the case of impeccable operation of the sensor. The sensor has to be calibrated / checked regularly!*
- *In the event of a sensor failure, uncontrolled chemicals addition may result. We therefore recommend urgently to activate “checkout time limits” with automatic control shut-off!*

NOTE

A form “Documentation of controller settings type D2C, pH/pH” is available under www.prominent.com/documentation_D2C_pH_pH for the purpose of documenting the controller settings.

3 Device Overview / Controls

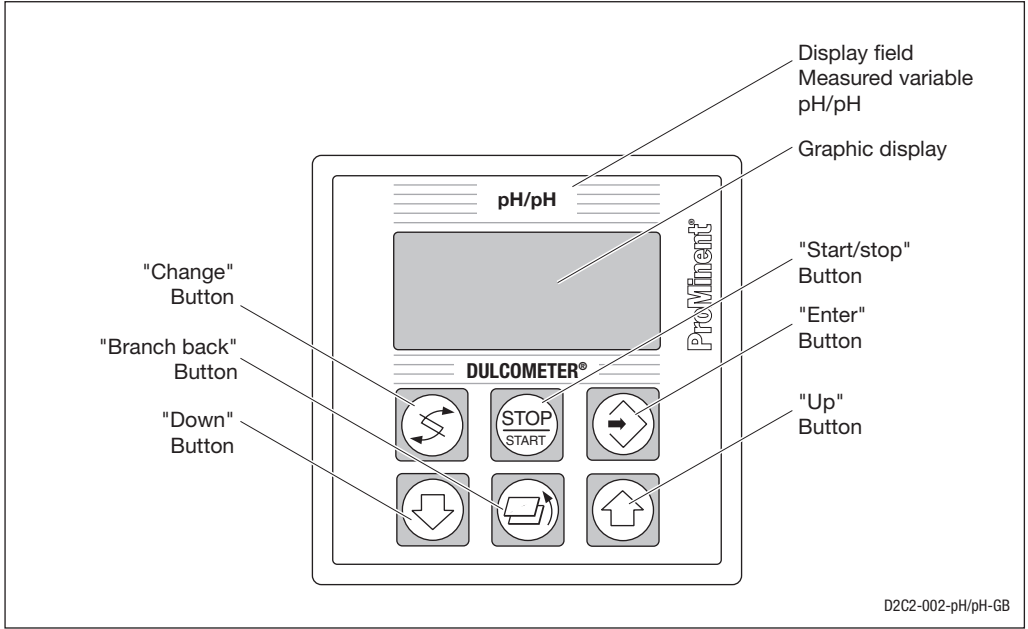

	<p>CHANGE button</p> <p>To change over within a menu level and to change from one variable to another within a menu point.</p>
	<p>START/STOP button</p> <p>Start/Stop of control and metering function.</p>
	<p>ENTER button</p> <p>To accept, confirm or save a displayed value or status. For alarm acknowledgement.</p>

	<p>UP button</p> <p>To increase a displayed numerical value and to change variables (flashing display)</p>
	<p>BRANCH BACK button</p> <p>Back to permanent display or to start of relevant setting menu.</p>
	<p>DOWN button</p> <p>To decrease a displayed numerical value and to change variables (flashing display).</p>

4 Functional Description

NOTE

Please refer to the description of the operating menu for a detailed description of the individual characteristics of the DULCOMETER® D2C controller.

4.1 Operating Menu

The DULCOMETER® D2C controller permits settings to be made in two different menus. All values are preset and can be changed in the complete operating menu.

The controller is delivered with a restricted operating menu so that the DULCOMETER® D2C controller can be used effectively in many applications from the very onset. If adaptations prove to be necessary, all relevant parameters can then be accessed by switching over to the complete operating menu.

4.2 Access Code

Access to the setting menu can be prevented by setting up an access code. The D2C controller is supplied with the access code 5000 which permits free access to the setting menu. The calibration menu remains freely accessible even if access to the setting menu is blocked by the code.

4.3 Control

The D2C can operate as a proportional controller or as a PID controller - depending on the device version (see identity code) and the setting.

The controller variable is recalculated every second. Control procedures which require rapid correction of setpoint deviations (less than approx. 30 seconds) cannot be processed with this controller. Take cycle times into account in the case of solenoid valve control (pulse length).

















The control function (control variable output) can be deactivated via the pause function and the sample water control input. The calculation of the regulated variable starts again with the inactivation of the "pause" after expiry of the adjustable delay time "td". No fault treatment is performed with active "pause" function.

4.4 Fault messages

Faults to be acknowledged are shown in the permanent displays 1, 3 and 4 by the symbol "E". The corresponding fault messages and notes are shown in the permanent display 2. Faults/notes continuing after acknowledgement are shown alternatively. Faults automatically remedied through changing operating conditions are removed from the permanent display without necessitating acknowledgement. Chapter 10 includes an overview of fault messages and causes.

5 Display Symbols

The display of the DULCOMETER® D2C controller uses the following symbols:

Symbol	Description	Comment
	Limit value transgression Relay 1 upper or zone	Symbol left
	Relay 1 lower	Symbol left
	Limit value transgression Relay 2 upper or zone	Symbol right
	Relay 2 lower	Symbol right
	Metering pump 1 (acid) Control off	Symbol left
	Control on	Symbol left
	Metering pump 2 (alkali) Control off	Symbol right
	Control on	Symbol right
	Solenoid valve 1 (acid) Control off	Symbol left
	Control on	Symbol left
	Solenoid valve 2 (alkali) Control off	Symbol right
	Control on	Symbol right
	Stop button pressed	
	Manual metering	
pause 	Delay time „td“	Control starts after expiry of „td“
	Fault	

6 Operation diagram

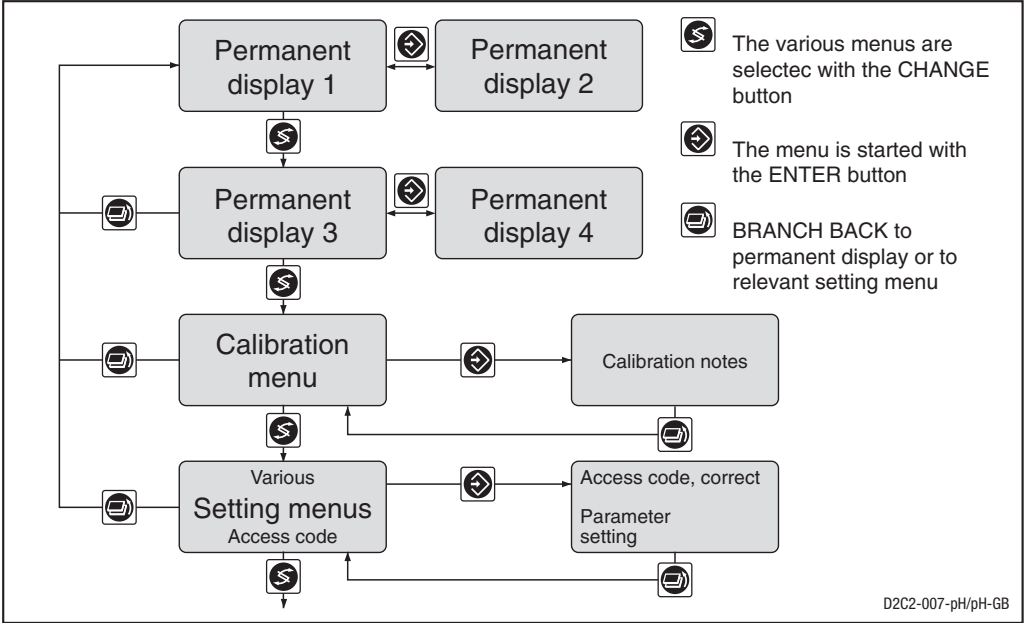

NOTE

Access to the setting menus can be barred with the access code!

The number and scope of setting menu depends on the device version!

If the access code is selected correctly in a setting menu, the following setting menus are also accessible!

If within a period of 10 minutes no button is pushed, the unit automatically branches back from the setting menu to the permanent display 1.

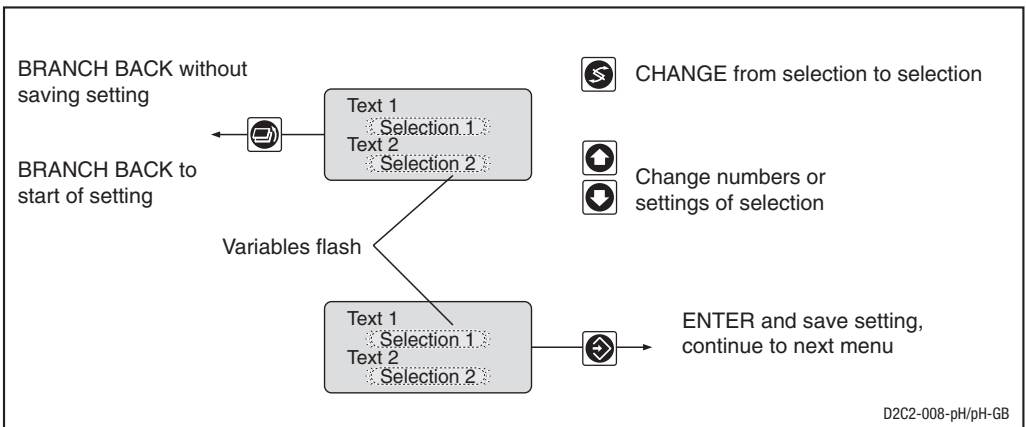

7 Operating Menu / Overview

The setting menus highlighted in grey and the adjustable parameters are only visible in the complete operating menu.

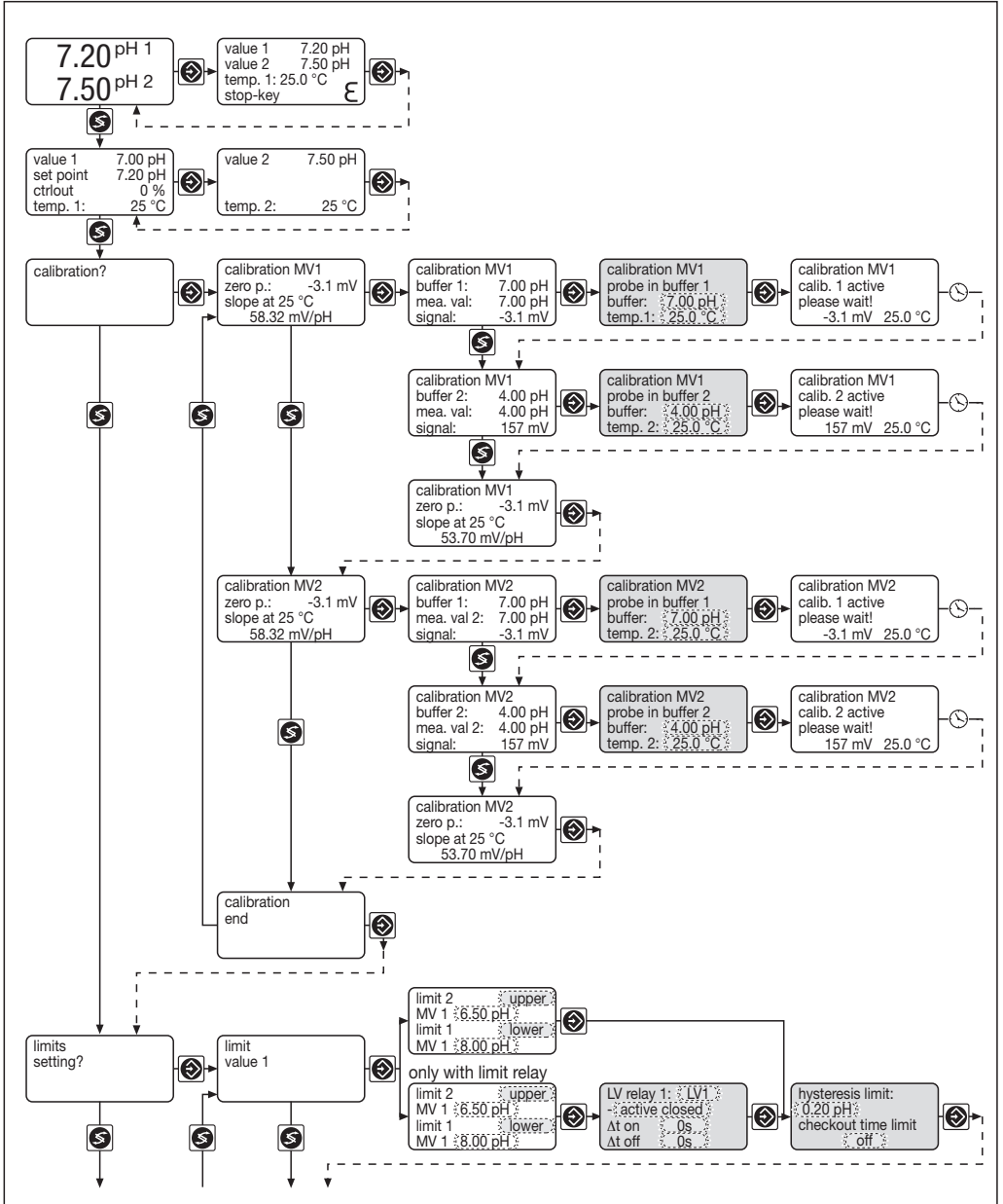

Operating Menu / Overview

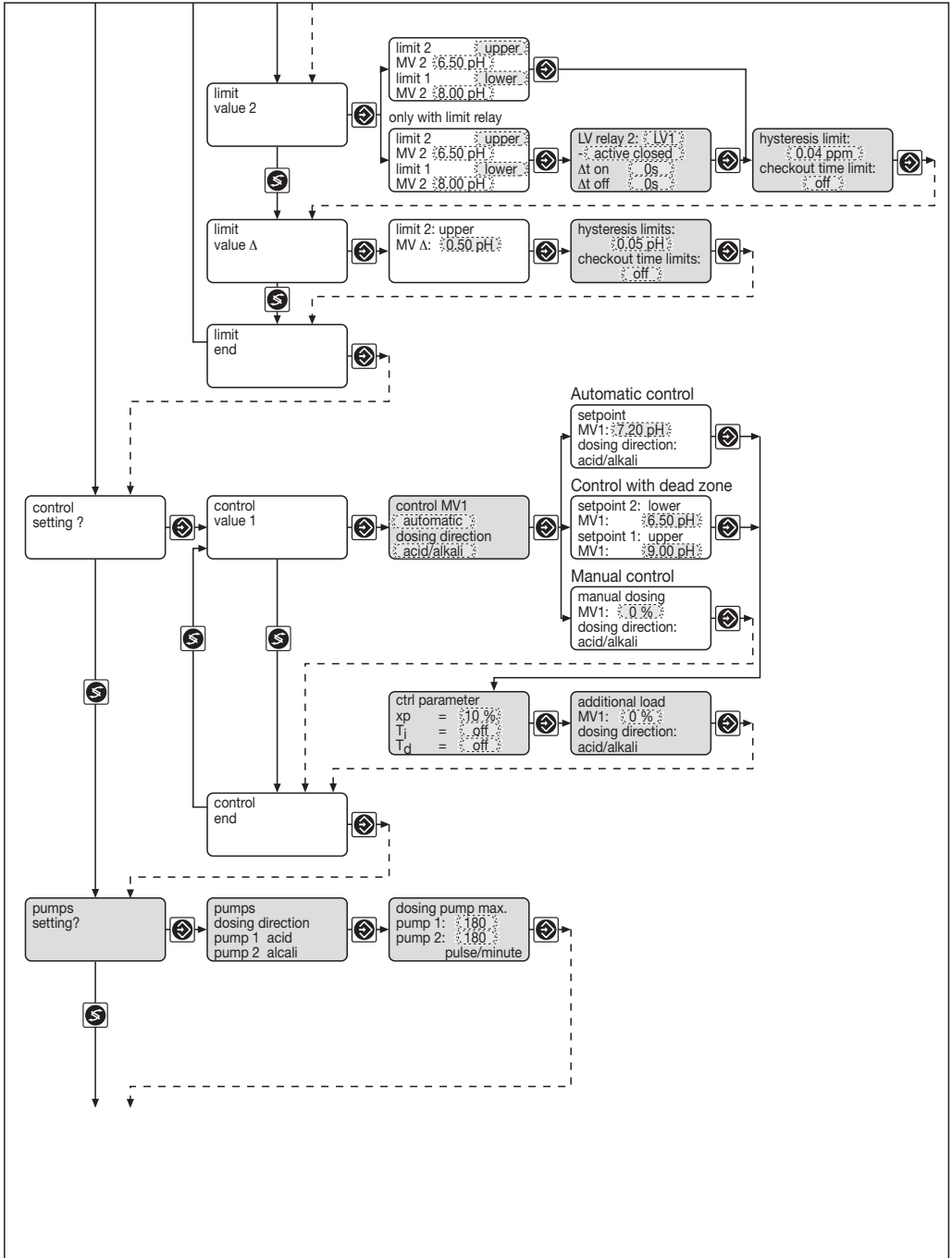

Operating Menu / Overview

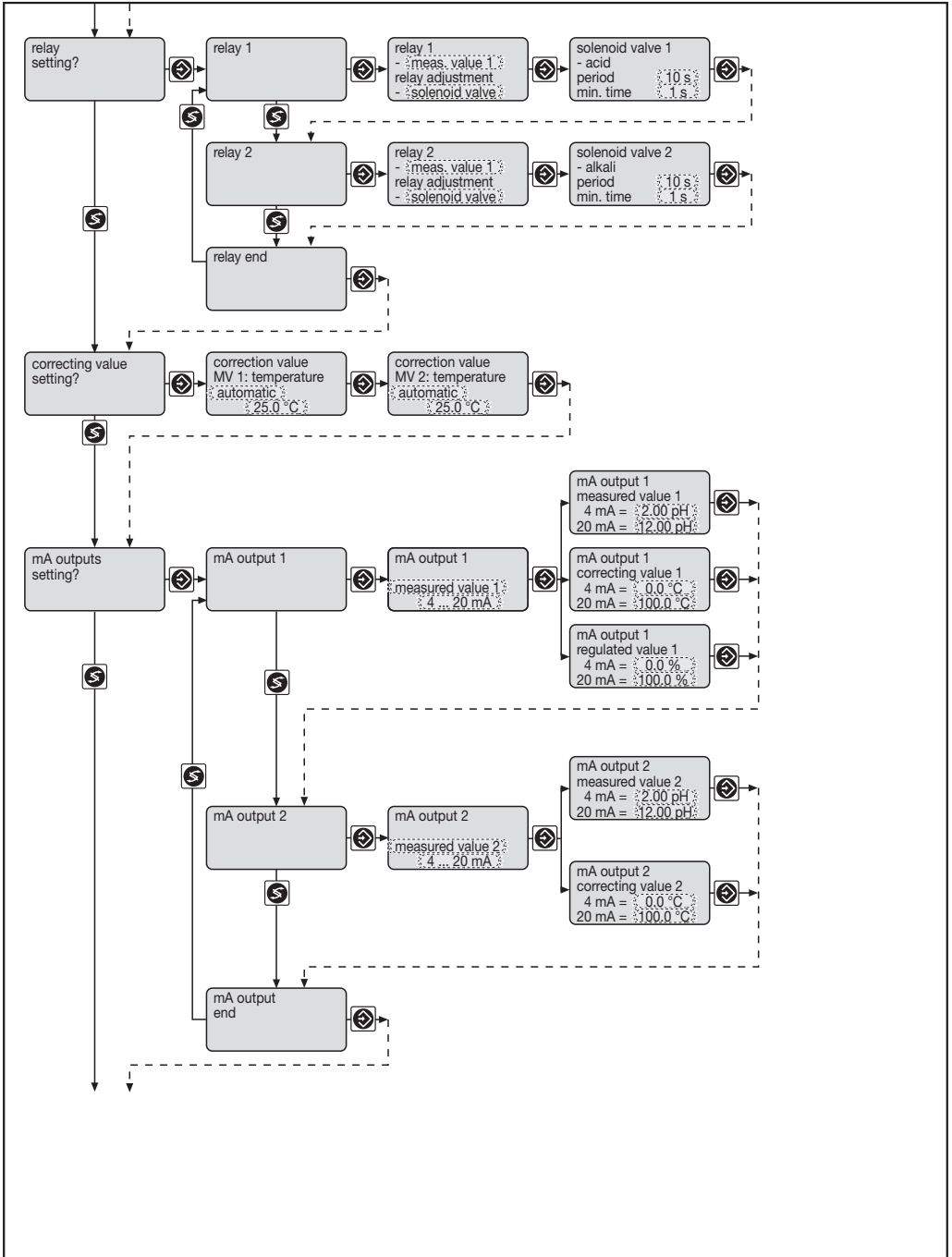

Operating Menu / Overview

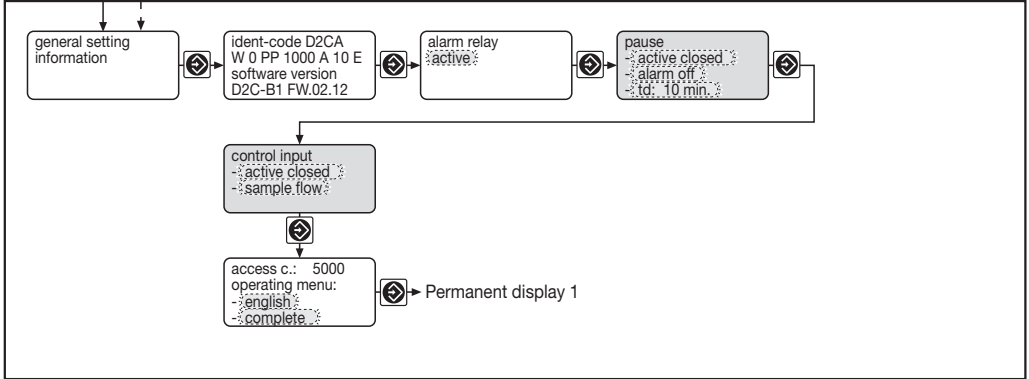

8 Operating Menu / Description

Permanent displays

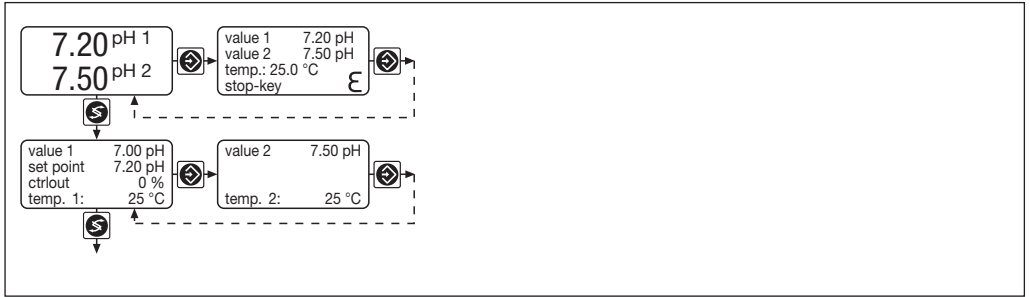

The permanent displays 1 to 4 serve information on fault messages/causes (see also table on page 24) as well as operating values/settings.

Calibration

Calibration of pH sensors (measuring value 1, 2):

The calibration of the pH sensors MV 1 and MV 2 uses a two-point calibration method (zero point, slope). As buffer pH 7 (zero point calibration) and pH 4 (slope calibration) are factory-set. If other buffers are to be used, the defaults in the complete operating menu (menu A, B) may be altered. If the temperature correction takes place manually or automatically, the actual buffer temperature must be entered or the Pt 100 immersed in the buffer solution. During calibration, control is stopped and metering is reduced to the set basic load. The output 0/4...20 mA (measuring value and correcting value) will be frozen. After successful calibration, all fault determinations relating to the measuring value are started again. The current sensor data (zero point/slope) will be displayed.

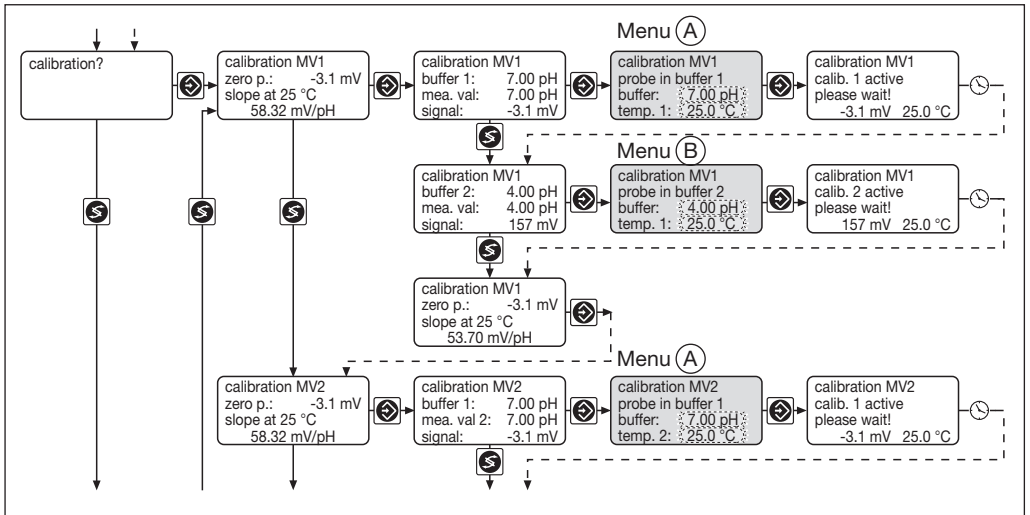

Operating Menu / Description

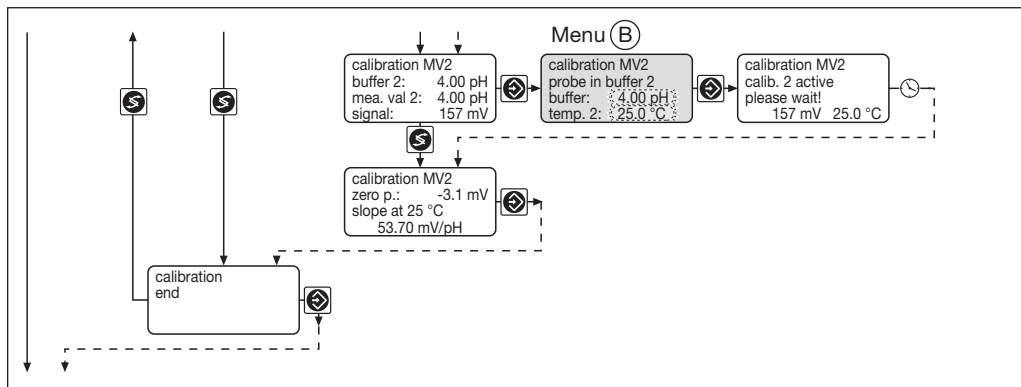

	Initial value	Possible values			Remarks
		Increment	Lower value	Upper value	
Buffer values	pH 7 pH 4	pH 0.01	pH -2	pH 16	Error messages when both buffers too close (<2 pH-values)

Error message	Condition	Effect	
Δ Buffer < pH 2	Δ Buffer < pH 2	During calibration procedure: recalibrate buffer 2!	
pH zero point low pH zero point high pH slope low pH slope high Measured value pH unsteady	< -60 mV > +60 mV < 40 mV/pH > 65 mV/pH	Return to permanent display: Basic metering load " "	Warning, old zero point and slope retained " " " "
Measured value temp. unsteady			"

Limit values

When setting the checkout time, metering of the corresponding pump is stopped and an alarm is triggered through the alarm relay in the event of limit violations (LV measured value 1, LV measured value Δ) exceeding the set checkout time. The control time can be reset by pressing the enter key!

For devices with limit relays, a limit value or a zone may be set for each measuring value, where the relay will switch.

Operating Menu / Description

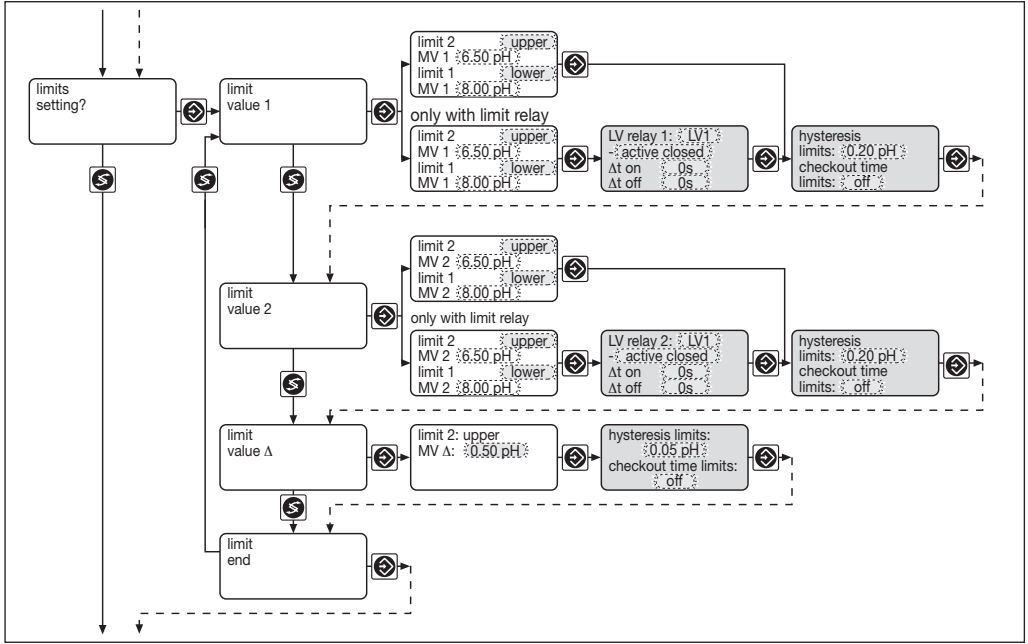

	Initial value	Possible values Increment	Lower value	Upper value	Remarks
Type of limit transgression					Limit transgression when exceeding or dropping below value
Limit value 1	lower	lower upper			
Limit value 2	upper	lower upper			
Limit value Δ	upper				
Measured value 1	pH 6.5 pH 8.0	pH 0.01 pH 0.01	pH -2.0 pH -2.0	pH 16 pH 16	
Limit relay 1	zone*	LV 1 LV 2 zone* off			*with regard to the setting „zone“, the difference between the limits and the set hysteresis should be >3 x.
Measured value 2	pH 6.5 pH 8.0	pH 0.01 pH 0.01	pH -2.0 pH -2.0	pH 16 pH 16	
Limit relay 2	zone	LV 1 LV 2 zone off			

Operating Menu / Description

	Initial value	Possible values Increment	Lower value	Upper value	Remarks
Measured value Δ Limit relay 2	pH 0.5 LV 2	pH 0.01 LV 2 off	pH 0.0	pH 14.0	
Limit relay 1, 2	active closed	active closed active open			
Switch-on delay Δt on	0 s	1 s	0 s	9999 s	
Switch-off delay Δt off	0 s	1 s	0 s	9999 s	
Hysteresis limits					
Measured value 1	pH 0.2	pH 0.01	pH 0.02	pH 16	Is active in the direction of cancellation of limit violation.
Measured value 2	pH 0.2	pH 0.01	pH 0.02	pH 16	
Measured value Δ	pH 0.5	pH 0.01	pH 0.02	pH 14	
Checkout time limits	off	1 s	1 s	9999 s	
					Results in message and alarm and shutting-off of the corresponding metering. Off: function off, no message, no alarm.

Control

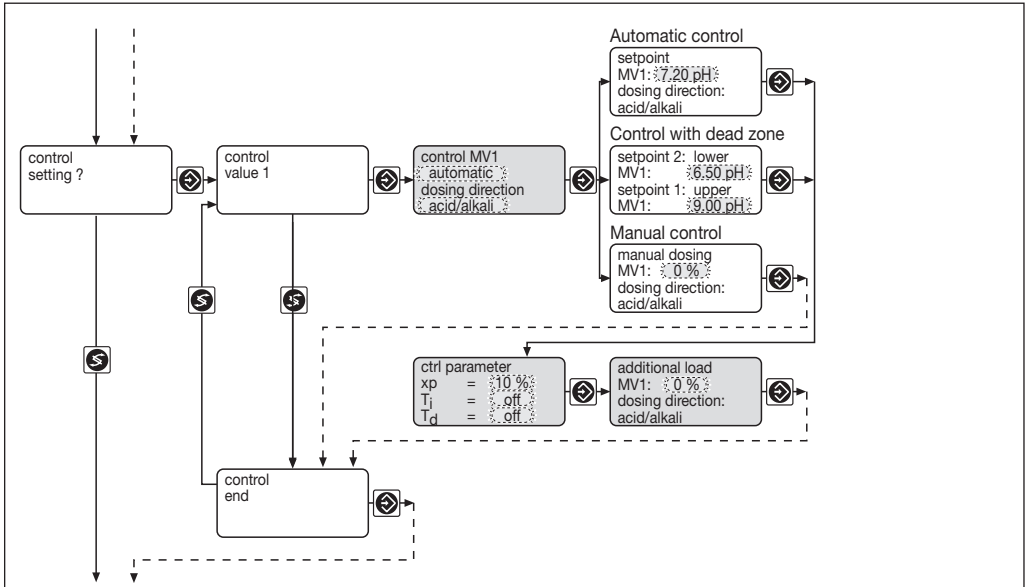

Operating Menu / Description

	Initial value	Possible values Increment	Lower value	Upper value	Remarks
Control MV 1	automatic	automatic auto with dead zone manual off			Setpoint 1 ≤ setpoint 2 xp referred to pH 14 (measured value 1; 2)
Metering direction MV 1	acid/alkali	acid/alkali acid alkali			
Setpoint 1/2	pH 7.20	pH 0.01	pH 0	pH 14.00	
Control parameter xp	10 %	1 %	1 %	500 %	
Control parameter Ti	off	1 s	1 s	9999 s	
Control parameter Td	off	1 s	1 s	2500 s	
Additional load	0 %	1 %	-100 %	+100 %	
Manual metering	0 %	1 %	-100 %	+100 %	

Pumps

The maximum stroke value of the metering pumps should correspond to the stroke frequency of the metering pump used.

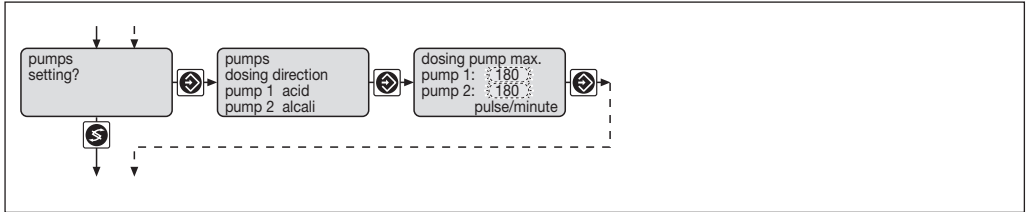

	Initial value	Possible values Increment	Lower value	Upper value	Remarks
Max. strokes/min. for pumps 1 and 2	180	1	1	500	
Pump 2	Measured value 1	Measured value 1 Measured value 2 Measured value Δ			
Metering direction	alkali	off acid alkali			

Operating Menu / Description

Relays

Allocation of the two relays with regard to measured value and function (limit value, actuator, solenoid valve) is freely selectable. If the function is set to actuator, solenoid valve, the relays will be set inactive in the case of fault in order to avoid faulty metering.

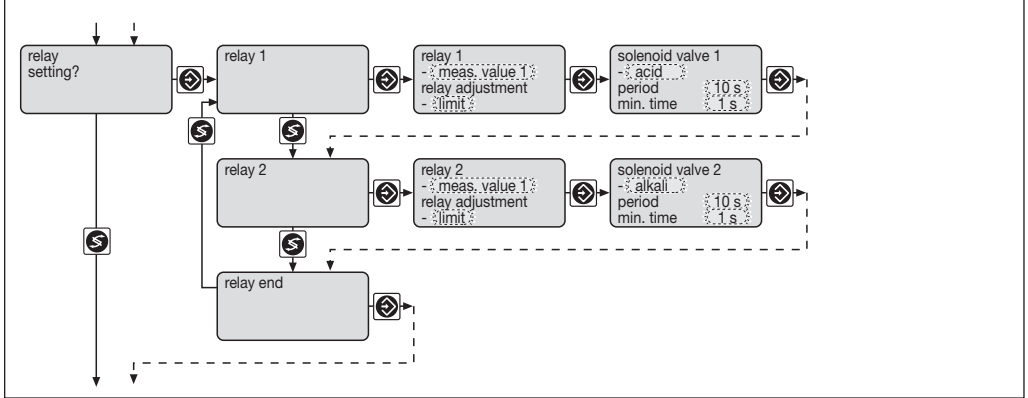

	Initial value	Possible values Increment	Lower value	Upper value	Remarks
Relay 1 Measured value	Measured value 1	Measured value 1 off			
Relay adjustment	as per identity code	Limit Actuator Solenoid valve			
Relay 2 Measured value	Measured value 1	Measured value 1 off			
Relay adjustment	as per identity code	Limit Actuator Solenoid valve			
Solenoid valve Period	10 s	1 s	10 s	9999 s	
Min. time	1 s	1 s	1 s	period/2	

Operating Menu / Description

Correcting variable

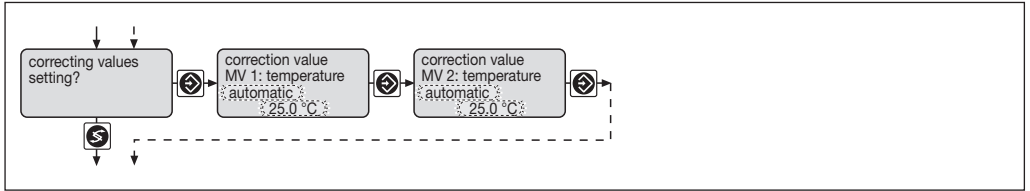

	Initial value	Possible values Increment	Lower value	Upper value	Remarks
Measured value 1	automatic	automatic manual off			
Measured value 2	manual	automatic manual off			
Manual correction	25.0 °C	0.1 °C	0.0 °C	100 °C	
Automatic correction	Measured value	0.1 °C	Measured value -5 °C	Measured value +5 °C	

Operating Menu / Description

Outputs 0/4 - 20 mA

The mA outputs can be used either to document the measured value of the correction variable or as regulated value. For the setting 'regulated value', the metering direction selected under control will be automatically used.

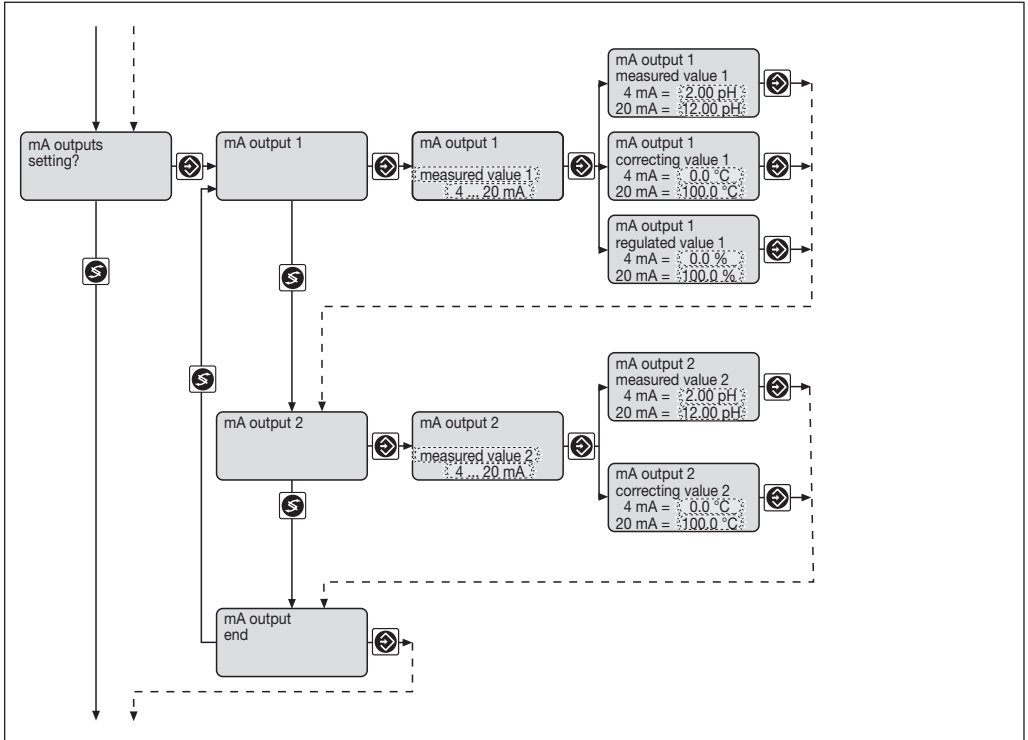

	Initial value	Possible values			Remarks
		Increment	Lower value	Upper value	
Allocation mA-output 1	Measured value 1	Measured value 1 Measured value 2 Regulated value 1 Correcting value 1 Correcting value 2 off			
Allocation mA-output 2	Measured value 2	Measured value 1 Measured value 2 Correcting value 1 Correcting value 2 Regulated value 1 off			
Signal range	4...20 mA	4...20 mA 0...20 mA			

Operating Menu / Description

	Initial value	Possible values			Remarks
		Increment	Lower value	Upper value	
Range measured value	pH 2...pH 12	pH 0.01	pH -2.0	pH 16.0	Minimum 1 %
Range regulated value	0...100 %	1 %	-100 %	100 %	Minimum 1 %
Range correcting variable	0...100 °C	0.1 °C	0.0 °C	100.0 °C	Minimum 1 %

General settings

Alarm relay

The alarm relay may be activated/deactivated. When deactivated, no fault message is displayed.

Pause function

With regard to the pause, a delay time "td" may be set. The control will start again only after cessation of the pause contact and expiry of the preset delay time. When the delay time is elapsing, a clock symbol will be displayed. The pause function may be reset by pressing the start/stop button.

Control input

The control input may be used for fault messages for sample water. In the event of fault message for sample water, control will be stopped, metering and the alarm relay will be activated.

Operating menu

All setting menus may be accessed by switching from restricted to complete. We recommend to set the restricted menu again after commissioning.

Access code

If the access code (factory-set to 5000) is altered, no settings with the exception of calibration may be carried out without entering the correct code.

Operating Menu / Description

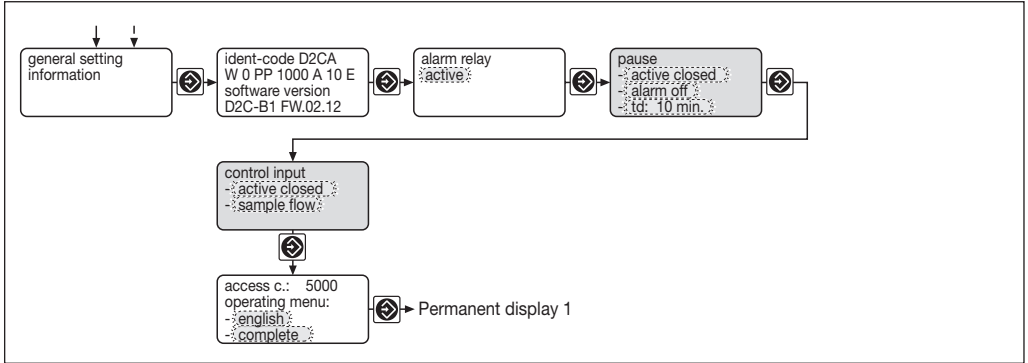

	Initial value	Possible values			Remarks
		Increment	Lower value	Upper value	
Alarm relay	active	active not active			
Pause	active closed	active closed active open			
	Alarm off	Alarm off Alarm on			
Control input	td: 10 min	1 min	0 min	60 min	
	sample water	sample water off			
Access code	active closed	active closed active open			
	5000	1	1	9999	
Language	as per identity code	German English French Spanish Swedish Dutch			
Operating menu	restricted	restricted complete			

9 Technical Terms

- Additive basic load:** This results in the fact that the controller always generates a manipulated value corresponding to the additive basic load. This load may only be reset to 0 using the stop button. This function should not be activated when using PI or PID controllers.
- Calibration:** By calibrating (adjusting), the measuring value readout will be adjusted to the actual sensor signal. Without calibration, a correct measurement is not possible. A calibration should be performed regularly (depending on application). If the DULCOMETER® D2C operates with automatic or manual temperature correction, a Pt 100 must be immersed in the buffer solution or the buffer temperatures entered manually.
- Control parameter:** The control parameters (xp, Ti, Td) determine the control characteristic (PID).
- Correction value:** The signal of the pH sensors (e.g. 59 mV/pH at 25 °C) is influenced by temperature. High temperatures increase the signal while low temperatures reduce the signal. The resulting measurement errors can be compensated for by way of temperature correction. As a rule, no correction is necessary for measurements conducted within the range around pH 7. However, if the measuring range is further away from pH 7, automatic temperature correction via Pt 100 should be implemented in the case of fluctuating temperatures. Manual temperature correction can be used if temperatures are constant. Automatic temperature correction can only be used for both measuring sensors if the temperature of the measured water is identical.
- Dead zone:** 2 setpoints can be specified in the "control with dead zone" setting. If the measured value is outside the setpoint range defined in this way, the corresponding actuator is activated. If the measured values are within the setpoint range, the controller functions as if the setpoint were reached. In the case of a P-controller, a controlled variable is then no longer produced. In the case of PI-controllers, the last controlled variable is retained.
- Limit value Δ :** In the limit value Δ setting, the difference of both pH measurements is monitored. If monitoring time Δ is activated, an alarm is automatically triggered via the alarm relay and the control variable is reset to 0 if values exceed the preset difference. This function serves the purpose of monitoring the pH measurement in critical applications.
- Manual control:** In this setting, the controller produces a controlled variable corresponding to the entry. It is retained up to the next change. It is independent of the measured variable and the set control parameters. This setting can be used for determining the time response (e.g. dead time...) of the controlled system.
- Metering direction:** This value determines in which direction the controller is active. In case of the metering direction "acid", the controller generates a manipulated value when the specified value for pH is exceeded. If the metering direction is set to acid/alkali solution, the controller operates as a 2-side controller.
- Regulated value:** The regulated value is the value (e.g. frequency, mA signal) the controller sends to the final controlling element, e.g. metering pump to reach again the set point.
- Relay:** The relay (alarm, limit relay) switches when the corresponding prerequisites (e.g. alarm condition, limit violation) are given. The relay function can be set either as make contact (active = closed) or break contact (active = open). The relay may be reset pressing the stop button. Exception: limit value.
- Solenoid valve:** Activation of solenoid valves (motor-driven pumps) is defined by the cycle time and the minimum on-state interval (minimum time) (pulse length control). The on-state interval always corresponds to at least the minimum time. However, it is increased up to the cycle time at a maximum depending on the control deviation and the control response. The cycle time itself defines the maximum possible on-state operations. For instance, an actuator is switched on a maximum of 60 times per hour when the

Technical Terms

cycle time is at 60 seconds. The minimum time defines the minimum on-state interval duration. It should be selected as small as possible while, however, ensuring that metering is still possible within this time.

- Set point:** The set point is the value which is to be continuously maintained stable throughout the process via controlling.
- Slope:** The slope of pH sensors should always be >50 (better >55) mV/pH.
- Temperature correction:** See correction value
- Ti (integral-action time):** This term defines the integral (I) control response. The greater the T_n, the weaker the I-component.
- Td (derivative action time):** This term defines the differential (D) control response. The smaller the T_d, the weaker the D-component.
- xp-value:** This value influences the proportional control behaviour. In case of a deviation of 1.4 pH (=10% of 14 pH) resp. 0.2 ppm (=10% of 2 ppm), a xp value of 10 %, for example, leads to a regulated value of 100%. If the xp value has to be increased to 20 %, the deviation must be double the value in order to reach a regulated value of 100 %. In case of control overshooting, the set xp value must be doubled.
- Zero point:** The zero point of pH sensors is theoretically 0 mV. In practice, for a good sensor function a zero point of ± 25 mV is acceptable.
- The zero point of the chlorine sensors is at 4 mA. Calibration is not necessary.

10 Faults / Notes / Troubleshooting

Fault	Fault text	Symbol	Effect on metering	Effect on control	Alarm with acknowledgement	Remarks	Remedy
Measured value 1 Signal exceeded/ drops below value	MV 1-input ↓↑	€	Basic load	Stop	yes	3 mA>signal>23 mA -499 mV>signal>499 mV	Check sensor, transducer and cable connection
Calibration with error	MV 1-calibration defect	€	Basic load	Stop	no		Check sensor, clean, replace if necessary, recalibrate if necessary
Measured value 2 Signal exceeded/ drops below value	MV 2-input ↓↑	€	none	none	yes	3 mA>signal>23 mA	Check sensor, transducer and cable connection
Calibration with error	MV 2-calibration defect	€	none	none	no		Check sensor, clean, replace if necessary, recalibrate if necessary
Limit transgression after checkout time	MV 1-limit 1 ↓↑ MV 1-limit 2 ↓↑ MV 2-limit 1 ↓↑ MV 2-limit 2 ↓↑ MV A-limit ↓↑	€	none	none	yes	Function detachable. Confirmation cancels the fault.	
Correction variable Signal exceeded/ drops below value	°C-input ↓↑	€	Basic load for measured value 1	Stop for measured value 1	yes	Signal ~100 Ω or ~138.5 Ω	

Operation	Note text	Symbol	Effect on metering	Effect on control	Alarm with acknowledgement	Remarks	Remedy
Stop button	Stop button	€ O	none	Stop	no		Start device
Pause contact	Pause	€ O	none	Stop	yes, can be deactivated	delay time td adjustable, ☹ display elapsing td	Deactivate pause, deactivate delay time „td“
Fault sample water	Fault sample water	€	none	Stop	yes	Function switchable	
Electronic fault	EEPROM defective	€	none	Stop	yes		Send in device

©1999 ProMinent Dosieretechnik GmbH · D-69123 Heidelberg
 Operating Instruction DULCOMETER® D2C, Part 2, pH/pH
 Subject to technical modifications · Printed in Germany

Addresses and delivery information may be obtained from the manufacturer.
 ProMinent Dosieretechnik GmbH · Im Schuhmachergewann 5-11 · D-69123 Heidelberg
 Phone: +49 (6221) 842-0 · Fax: +49 (6221) 842-419
 info@prominent.com · www.prominent.com