

Supplemental manual

delta® DLTa and Sigma SxCb with PROFIBUS®

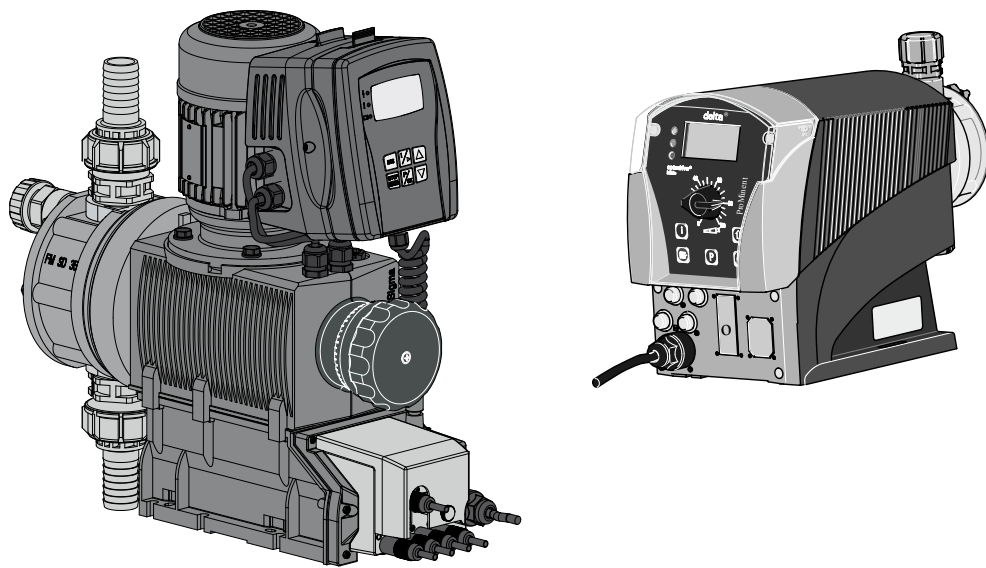

This operating manual is only valid in conjunction with the "Operating manual: delta® solenoid metering pump with opto-Drive® DLTa regulated solenoid drive" or "Operating manual: Sigma/ x control type SxCb motor metering pump"!

The operator shall be liable for damage caused by errors during installation and operation!

Please carefully read these operating instructions before use! · Do not discard!
The operator shall be liable for any damage caused by installation or operating errors!
Technical changes reserved.

ProMinent Dosiertechnik GmbH
Im Schuhmachergewann 5-11
69123 Heidelberg
Germany
Telephone: +49 6221 842-0
Fax: +49 6221 842-617
email: info@prominent.com
Internet: www.prominent.com

985400, 1, en_GB

Table of contents

1	Prerequisites	4
2	Setting up the pump	5
	2.1 General information.....	5
	2.2 Setting a slave address.....	5
	2.3 Activating / deactivating the PROFIBUS®.....	5
3	Particular features of PROFIBUS® mode	6
	3.1 General information.....	6
	3.2 Displays and indicators.....	6
	3.3 LEDs on the PROFIBUS® module.....	6
	3.4 Using the metering monitor.....	7
4	Installation	8
5	Operation	10
	5.1 General information.....	10
	5.2 GSD file.....	10
	5.3 Description of the data objects.....	10
	5.4 Cyclical data traffic.....	14
	5.4.1 Overview of the data objects.....	14
	5.4.2 Configuration.....	17
	5.5 Acyclical data traffic.....	20
	5.6 Extended diagnostic.....	21

1 Prerequisites

The pump can be expanded to include PROFIBUS® functionality using a plug-in module. Plug the plug-in module into the front of the pump (the same way as with a relay module). The menu item "PROFIBUS®" will then appear in the operating menu.



The pump must have at least software version V01.03.06.00 (delta® DLTa) or V01.01.00.00 (Sigma Control SxCb) and hardware version V01.04.00.00 for the delta®, for the PROFIBUS® module to work. If it does not work, the LED on the PROFIBUS® module slowly flashes red and green.

2 Setting up the pump

2.1 General information

The pump with the PROFIBUS® module plugged in is set up in the same way as the standard pump; it just includes the bus functionality.



If there is no activity for longer than 60 sec., the setup process is cancelled.

2.2 Setting a slave address

The default address is "125". If a master in the PROFIBUS® section issues the slave addresses, then setting the slave address manually is not necessary.

1. ➤ Press the *[P]* button for 2 seconds.
2. ➤ delta® only: Move to 'Settings' with the *[arrow buttons]* and press the *[P]* button.
3. ➤ Move to 'PROFIBUS®' with the *[arrow buttons]* and press the *[P]* button.
4. ➤ Move to 'Address' with the *[arrow buttons]* and press the *[P]* button.

Always use three digits for the PROFIBUS® address (addresses from "002" to "125"):

1. ➤ Set the first digit with the *[Down]* button and press the *[P]* button.
2. ➤ Set the second digit with the *[Down]* button and press the *[P]* button.
3. ➤ Set the third digit with the *[arrow buttons]* and press the *[P]* button.

2.3 Activating / deactivating the PROFIBUS®

So that the pump can be controlled via the PROFIBUS®, 'PROFIBUS®' must be set to 'Active' in the operating menu:

1. ➤ Press the *[P]* button for 2 seconds.
2. ➤ With the *[arrow buttons]* move to 'PROFIBUS®' and press the *[P]* button.
3. ➤ With the *[arrow buttons]* move to 'Active' or 'Inactive' and press the *[P]* button. You're done!

Even while the PROFIBUS® is 'Active', all the external inputs such as level monitor, metering monitor and external control (pause, contact input, analogue input) still work. They produce the anticipated reactions, just as if the pump was being operated without the PROFIBUS® module plugged in - see the pump operating manual. The pump transmits relevant information over the PROFIBUS® to the master (PLC, PC, etc.).

If the PROFIBUS® is set to 'Inactive', the settings of the previously selected operating mode are reloaded.

If the pump is switched to another operating mode, then it stops and can only be started via the *[Stop/Start]* button.

3 Particular features of PROFIBUS® mode

3.1 General information



In PROFIBUS® mode, the pump cannot be manually adjusted or programmed! To do so, switch the PROFIBUS® to 'Inactive'.

- Using the [i] button, you can switch between the permanent displays at any time, as in the other operating modes. This has no influence upon the operation of the pump.
- When switching to PROFIBUS® mode, the settings are carried over from other operating modes. **Settings made via the PROFIBUS®, on the other hand, are not saved!** They are only valid while the pump is connected to the PROFIBUS®. Only the total number of strokes and total litres figures are continuous (saved).
- If the pump is switched to PROFIBUS® mode, then it stops and can only be started via the PROFIBUS®.

3.2 Displays and indicators

Operation indicator

During PROFIBUS® mode, the operation indicator contains additional symbols.





Commonly used symbols can be found in the chapter "Control elements" in the "Operating manual: delta® solenoid metering pump with controlled optoDrive® solenoid drive" or the "Operating manual: Sigma/ x control type SxCb motor metering pump".

Status indicator

 Stop PROFIBUS®: the pump was stopped via the PROFIBUS®. The master transmits an appropriate telegram to the pump.

Main indicator

 Connection error: if the pump loses its connection to the PROFIBUS® (e.g. when the PROFIBUS® is stopped), then the error symbol  appears and the  symbol flashes in the main indicator.

3.3 LEDs on the PROFIBUS® module

LEDs	Cause
Slowly flashing red and green	Connection between PROFIBUS® module and pump has failed; the hardware or software version of the pump may not be suitable for PROFIBUS®
Permanently lit red	No connection to the PROFIBUS®
Permanently lit green	Pump in cyclic operation

3.4 Using the metering monitor

To use the metering monitor during PROFIBUS® mode, the "Metering monitor" socket must be connected. The pump then transmits *'Present'* for the "Flow" status bit. The metering monitor can be switched on and off with the PROFIBUS® using the *'Flow monitoring'* parameter - see ↪ *'Data on the pump'* Table on page 15.

4 Installation

Bus installation

All bus subscribers must be connected in series. Up to 32 stations are possible (masters, slaves, repeaters).

At both the start and end of the cabling, the bus must be connected with a terminating resistor.

Connectors and cables

For the PROFIBUS® cables, use cables which are shielded, twisted, and have two-cores (twisted pair), in accordance with EN 50170 (cable type A).



Earthing the shield at one end prevents low-frequency earth loops. Earthing the shield at one end has no effect on HF magnetic interference. Earthing the shield at both ends and the twisted pair do indeed affect the HF magnetic interference, though it has no effect upon HF electrical interference.

It is recommended to establish on the PROFIBUS® a low-inductance (i.e. wide area and low resistance) connection to the protective earth on both sides.

The total length of the bus cabling without repeaters will vary depending on the desired transfer speed:

Transfer speed and length of the bus cabling

Transfer speed	Max. length of the bus cabling
kBit/s	m
1500	200
500	400
187.5	1000
93.75	1200
19.2	1200
9.6	1200

The PROFIBUS® module has an M12 industrial socket for connecting to a PROFIBUS® cable. The pin allocation corresponds to the PROFIBUS® standard - see below - meaning that commercially available bus connectors can be used. Please note that cable connections with these connectors generally only comply with a contact and humidity protection according to IP 20!

Information on achieving protection class IP 65

An installation compliant with contact and humidity protection according to IP 65 is possible, as the M12 industrial socket on the PROFIBUS® module allows for this. However, the PROFIBUS® cable must then be equipped with M12 industrial connectors according to IP 65.

In order to achieve protection class IP 65 for the PROFIBUS® cable installation, special Y-adapters or termination adapters must be used (e.g. - see below).



CAUTION!

- Protection class IP 65 only applies to a mated connector/socket combination!
- For ambient conditions requiring contact and humidity protection according to IP 65, cables with cast M12 industrial connectors must be used (e.g. see below).
- Protection class IP 65 only applies to an uncabled pump (with PROFIBUS® module) if an IP 65-capable cover is attached to the M12 industrial socket! The supplied cover does not guarantee resistance to chemicals.

Socket on the PROFIBUS® module (M12)

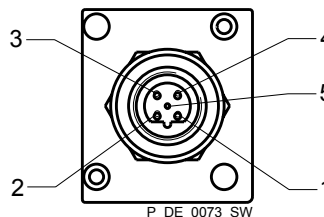

- 1 5 V
- 2 A-cable (green)
- 3 Earth
- 4 B-cable (red)
- 5 Shield

Y-adapter (order no. 1040956)

The Y-adapter connects the pump with a cast M12 connector. The ends are equipped with one M12 connector and one M12 socket. The Y-adapter fulfils the contact and humidity protection requirements according to IP 65.

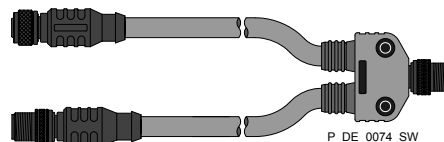

PROFIBUS® termination, complete (order no. 1040955)

If the pump is the last bus subscriber connected to the PROFIBUS® cable, it must be connected with the PROFIBUS® termination, complete, to act as a termination - see EN 50170. The PROFIBUS® termination, complete, fulfils the contact and humidity protection requirements according to IP 65 (it consists of a Y-connector and a terminating resistor).

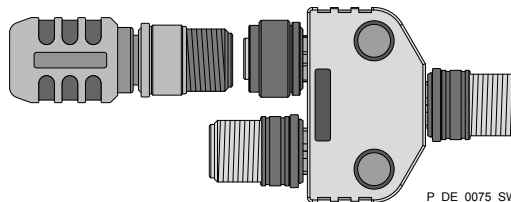

5 Operation

5.1 General information

With the PROFIBUS® module plugged in, the pump represents a subscriber with slave functionality in the PROFIBUS®, according to DP-V1. Usage data is then transferred both cyclically and acyclically.

5.2 GSD file

The GSD file must be used to configure the masters. It describes all features of the pump in PROFIBUS® mode (keywords, diagnostics, modules, slots). The GSD file can be downloaded from the PROFIBUS® website and from the ProMinent website. The file name is unique: PROM0B02.GSD

5.3 Description of the data objects

Description of the data objects



So that the pump can join the cyclic data traffic, the initial parameters must be transferred from the master. This only requires the default parameter settings - there are no application parameters.



Please note: the data is stored according to the "Big Endian" principle! i.e. the byte with the highest-valued bits is stored first - it is therefore held in the lowest address in memory. For an example using "Status" - see ↗ 'Data from the pump (input data)' Table on page 15.

As a UINT32 type, the status of the pump is based on the offset addresses +0 to +3. Storage of the bytes occurs in this order:

Name	Type	Offset	Byte	Bits
Status	UINT32	+0	0	24 - 31
		+1	1	16 - 23
		+2	2	8 - 15
		+3	3	0 - 7

In the following, all data objects which can be transferred cyclically are described.

All data objects

Name	No.	Type	Description		
Device identification	0	UINT32	Byte 0+1	= 0x0B02	ID number
			Byte 2	= 0x50	ProMinent identifier for pumps product group
			Byte 3	= 5	"delta a" pump family
			Byte 3	= 3	"Sigma b" pump family

Name	No.	Type	Description			
Status	1	UINT32	Bit	Name	Function	
			0	System	00 – Init	03 –Test
			1		01 – Ready	04 - First run
			2		02 – Diagnose	05 - Power-down
			3	Mode	00 – halt	03 –contact
			4		01 – manual	04 - analog
			5		02 – batch	
			6	Error	There are errors - see "Errors"	
			7	Warnings	There are warnings - see "Warnings"	
			8	Stop	Pump is stopped	
			9	Intake	Pump is in intake mode (higher-level function)	
			10	Auxiliary	Pump is in auxiliary mode (higher-level function)	
			11	Pause	Pump is switched to pause (higher-level function)	
			12	Module	Automatic mode	
			13	Flow	Metering monitor activated	
			14	Batch mem.	Batch memory is activated	
			15	Calibrated	Pump is calibrated	
			16	Relay 1	Relay 1 is physically present	
			17	Relay 2	Relay 2 is physically present	
			18	AnalogOut	Module is physically present	
			19	Diaphragm break	Diaphragm break option is installed	
			20	Concentration	Concentration calculation is activated (delta® only)	
			21	-	-	
			22	-	-	
			23	Airlock	Drive controller signals air in the metering head (delta® only)	
			24	Excessive pressure	Drive controller signals "excessive counter pressure"	
			25	Depressurised	Drive controller signals "no counter pressure" (delta® only)	
			26	Bleeding	Pump is being bled (delta® only)	
			27	-	Always true	
			28	Direct mode	Pump functioning in direct mode (limited range of functionality) (delta® only)	
Start/Stop	2	BYTE	Corresponds with the Start/Stop switch; if Start/Stop = 0 then the pump is stopped.			

Operation

Name	No.	Type	Description		
Reset	3	BYTE	If the value of "Reset" switches from 1 to 0, the internal pump memory is reset (e.g. for batch metering) and - where possible - any pending errors are reset.		
Mode	4, 5	BYTE	Value	Name	Description
			0	Halt	Pump is ready but not metering.
			1	Manual	Pump is metering continuously at the set frequency.
			2	Charge	When triggered, pump is metering the number of strokes set under Batch preselection.
			3	Kontakt	Pump is metering the number of strokes calculated from the product of "Number of triggering points * External factor".
			4	Analog	Pump is metering in accordance with the analogue signal and the operating mode ' <i>Analogue</i> ' set on the pump.
Frequency	6, 7	UINT16	Set metering frequency in strokes / hour (0 - "Maximum frequency").		
Actual frequency	8	UINT16	Actual metering frequency in strokes / hour (0 - 'Maximum frequency').		
Maximum frequency	9	UINT16	Maximum metering frequency in strokes / hour (0 - 12,000). Based on which metering mode is set, the max. frequency can be substantially less than in normal mode.		
Batch preselection	10, 11	UINT32	Number of strokes in batch operation per triggering. (0...99999).		
Batch start	12	BYTE	If the value changes from 1 to 0, batch metering is triggered in batch mode. Batches can also be triggered via the contact input.		
Batch memory	13	BYTE	If the batch memory is activated and a new batch is triggered while batch metering is already ongoing, then the remaining strokes is increased by the number of the new batch. If the memory is not activated, the remaining strokes for the incomplete batch are deleted and the new batch is processed.		
Remaining strokes	14	UINT32	The number of strokes still to be processed for a batch		
External factor	15, 16	UINT16	Factor by which the incoming pulses are multiplied. The factor is provided in hundredths. The value range is 1 - 9999 - the factor is then 0.01 - 99.99.		
External memory	17	BYTE	As is the case for batch metering, the value is also added in this case for high factors, or the remaining strokes are deleted.		
Stroke length	18	BYTE	Set stroke length on the pump (0 - 100%)		
Metering monitor	19	BYTE	If the metering monitor is installed, it can be switched on (1). (0) is for switching it off.		
Concentration	20	FLOAT	If calculation of the concentration is activated on the pump, the current concentration can be viewed here (delta [®] only).		
Error	21	UINT16	Bit	Name	Function
			0	Minimum	Level of metered liquid too low
			1	Batch	Too many metering strokes > 100,000
			2		Analogue current is less than 4 mA

Name	No.	Type	Description		
			3	Analogue > 23mA	Analogue current is higher than 23 mA
			4	Metering monitor	Fault on metering monitor
			5	Diaphragm break	Diaphragm in metering head defective
			6	Airlock	Air in the metering head (delta® only)
			7	Excessive pressure	Excessive pressure in the hydraulic system
			8	-	-
			9	-	-
			10	Low pressure	Pressure in the hydraulic system is too low (delta® only)
			11	Stroke length changed	The stroke length has been changed in a locked state
			12	Bleeding	Automatic bleeding not possible (delta® only)
			13	Bus error	Bus error signalled by the module
			14	System error	System components defective - see LCD screen
			15	Module error	Error in the module handling
Warnings	22	UINT16	Bit	Name	Function
			0	Minimum	Level of metered liquid too low
			1	Calibration	Set stroke length out of calibration tolerance
			2	Metering monitor	Fault on metering monitor
			3	Diaphragm break	Diaphragm in metering head defective
			4	Airlock	Air in the metering head
			5	-	-
			6	-	-
			7	Excessive pressure	Excessive pressure in the hydraulic system
			8	Low pressure	Insufficient pressure in the hydraulic system
Stroke counter	23	UINT32	Counts the number of strokes since the last reset		
Reset stroke counter	24	BYTE	If the value changes from 1 to 0, the stroke counter is reset.		
Quantity counter	25	FLOAT	Counts the metering output in litres since the last reset		
Litres per stroke	26	FLOAT	Litres per stroke. Depends on the frequency and the stroke length setting		
Reset quantity counter	27	BYTE	If the value changes from 1 to 0, the quantity counter is reset		
ID code	28	STRING	Pump ID code (pump specification)		

Name	No.	Type	Description
Serial number	29	STRING	Pump serial number
Name	30	STRING	Pump name, freely-definable (max. 32 characters)
Installation site	31	STRING	Installation site, freely-definable (max. 32 characters)

5.4 Cyclical data traffic

DP-V0 describes the cyclical data traffic in the PROFIBUS®.

5.4.1 Overview of the data objects

The data objects are summarised in the modules and their configuration identifier - see following table. Thanks to the configuration identifier, modules can be excluded from the cyclical data traffic during configuration, so that the cyclical data traffic is not unduly burdened.

Modular structure

Module no.	Output	Length	Input	Length	Modulname	Configuration identifier (hex)
1	-	-	Status	4 bytes	Status	40,83
2	Start/Stop Reset	1 byte 1 byte	-	-	Control	80,81
3	Mode	1 byte	Mode	1 byte	Operating Mode	C0,80,80
4	Frequency	2 bytes	Frequency Actual frequency	2 bytes 2 bytes	Frequency	C0,81,83
5	-	-	Maximum frequency	2 bytes	Maximum Frequency	40,81
6	Batch preselection Batch start Batch memory	4 bytes 1 byte 1 byte	Batch preselection	4 bytes	Charging	C0,85,83
7	-	-	Remaining strokes	4 bytes	Remaining Strokes	40,83
8	External factor External memory	2 bytes 1 bytes	External factor	2 bytes	Transmission Multiplier	C0,82,81
9	-	-	Stroke length	1 byte	Stroke Length	40,80
10	Metering monitor	1 byte	-	-	Flow Control	80,80
11	-	-	Concentration	4 bytes	Concentration	80,80
12	-	-	Errors Warnings	2 bytes 2 bytes	Error Warning	40,83

Module no.	Output	Length	Input	Length	Modulname	Configuration identifier (hex)
13	Reset stroke counter	1 byte	Stroke counter	4 bytes	Stroke Number	C0,80,83
14	Reset quantity counter	1 byte	Quantity counter Litres per stroke	4 bytes 4 bytes	Quantity	C0,80,87

Data on the pump

Offset	Significance	Type	Name	Range	Modulname	Module no.
+0	-	BYTE	Start/Stop	0,1	Control	2
+1	-	BYTE	Reset	0,1↓	-	
+2	-	BYTE	Mode	See ↗ 'Mod-ular structure' Table on page 14	Operating Mode	3
+3	high	UINT16	Frequency	0 - Max. freq.	Frequency	4
+4	low					
+5	high	UINT32	Batch pre-selection	1 - 99999	Charging	6
+6	↓					
+7	low					
+8						
+9	-	BYTE	Batch start	0,1↓	-	
+10	-	BYTE	Batch memory	0,1	-	
+11	high	UINT16	External factor	0 - 9999	Transmission Multiplier	8
+12	low					
+13	-	BYTE	External memory	0,1	-	
+14	-	BYTE	Metering monitor	0,1	Flow Control	10
+15	-	BYTE	Reset stroke counter	0,1↓	Stroke Number	13
+16	-	BYTE	Reset quantity counter	0,1↓	Quantity	14

Data from the pump (input data)

Offset	Significance	Type	Name	Range	Modulname	Module no.
+0	high	UINT32	Status	See ↗ 'Data on the pump' Table on page 15	Status	1
+1	↓					
+2	low					
+3						
+4	-	BYTE	Mode	See ↗ 'Mod-ular structure' Table on page 14	Operating Mode	3

Operation

Offset	Significance	Type	Name	Range	Modulname	Module no.
+5	high	UINT16	Frequency	0 - Max. freq.	Frequency	4
+6	low					
+7	high	UINT16	Actual frequency	0 - Max. freq.		
+8	low					
+9	high	UINT16	Maximum frequency	0 - 12,000↓	Maximum Frequency	5
+10	low					
+11	high	UINT32	Batch preselection	1 - 99999	Charging	6
+12	↓					
+13	low					
+14						
+15	high	UINT32	Remaining strokes	1 - 99999	Remaining Strokes	7
+16	↓					
+17	low					
+18						
+19	high	UINT16	External factor	0 - 99999	Transmission Multiplier	8
+20	low					
+21	-	BYTE	Stroke length	0 - 100↓	Stroke Length	9
+22	high	FLOAT	Concentration (delta® only)	0.1ppm - 100%	Concentration	11
+23	↓					
+24	low					
+25						
+26	high	UINT16	Errors	See ↗ 'All data objects' Table on page 10	Error Warning	12
+27	low					
+28	high	UINT16	Warnings	See ↗ 'All data objects' Table on page 10		
+29	low					
+30	high	UINT32	Stroke counter	0 - (2 ³²)-1	Stroke Number	13
+31	↓					
+32	low					
+33						
+34	high	FLOAT	Quantity counter	- (litres)	Quantity	14
+35	↓					
+36	low					
+37						
+38	high	FLOAT	Litres per stroke	- (litres)		
+39	↓					
+40	low					
+41						

5.4.2 Configuration

On the master, you can select which modules are to take part in the cyclical data transfer. Modules and slots correspond to one another. Therefore, spaces (empty modules) must be configured for modules which are not to be included.

The target configuration is defined in the form of identifiers. ↪ *'Modular structure' Table on page 14* specifies the identifier for each defined module in the final column.

The module identifiers must be set in ascending order, one after another. If you do not want the data of a module to be involved in cyclical data transfer, then an empty module must be configured in this position.

Example configurations

Configuration for transferring all cyclical modules (42 byte input, 17 byte output)

Module 1	Module 2	Module 3	Module 4	Module 5	Module 6	Module 7	Module 8
40, 83	80, 81	C0, 80, 80	C0, 81, 83	80, 81	C0, 85, 83	40, 83	C0, 82, 81

Module 9	Module 10	Module 11	Module 12	Module 13	Module 14		
40, 83	80, 80	80, 80	40, 83	C0, 80, 83	C0, 80, 87		

The following table provides an example of a target configuration, in which modules 8, 10, 11 and 14 are excluded from the cyclical data traffic.

INFO

The data objects can still be reached acyclically.

Target configuration

Module 1	Module 2	Module 3	Module 4	Module 5	Module 6	Module 7	Module 8
40 83	80 81	C0 80 80	C0 81 83	80 81	C0 85 83	40 83	0

Module 9	Module 10	Module 11	Module 12	Module 13	Module 14		
40 80	0	0	40 83	C0 80 83	0		

The pump checks if the target configuration matches the actual configuration. If this is not the case, the pump reacts and transmits a configuration error in the standard diagnostic.

So that the check of the target configuration can function properly, the options for setting up the identifier formats must be restricted and the following rules should be observed.

- Always use the special identifier format for coding.
- Always use the byte structure as the format.
- Do not provide any manufacturer-specific data (e.g. data types).
- Modules must always be replaced with empty modules, to remove them from the cyclical data traffic.

Excluding individual modules from the cyclical data traffic causes the offset addresses of the transferred data objects to shift- see ↪ 'Data on the pump (reduced output data)' Table on page 18 and ↪ 'Data from the pump (reduced input data)' Table on page 19.

Data on the pump (reduced output data)

Offset	Significance	Type	Name	Range	Modulname	Module no.
+0	-	BYTE	Start/Stop	0,1	Control	2
+1	-	BYTE	Reset	0,1↓		
+2	-	BYTE	Mode	See ↪ 'Mod-ular structure' Table on page 14	Operating Mode	3
+3	high	UINT16	Frequency	0 - Max. freq.	Frequency	4
+4	low					

Offset	Significance	Type	Name	Range	Modulname	Module no.
+5	high	UINT32	Batch preselection	1 - 99999	Charging	6
+6	↓					
+7	low					
+8						
+9	-	BYTE	Batch start	0,1 ↓		
+10	-	BYTE	Batch memory	0,1		
+11	-	BYTE	Reset stroke counter	0,1 ↓	Stroke Number	13

Data from the pump (reduced input data)

Offset	Significance	Type	Name	Range	Modulname	Module no.
+0	high	UINT32	Status	See ↗ 'Data on the pump' Table on page 15	Status	1
+1	↓					
+2	low					
+3						
+4	-	BYTE	Mode	See ↗ 'Modular structure' Table on page 14	Operating Mode	3
+5	high	UINT16	Frequency	0 - Max. freq.	Frequency	4
+6	low					
+7	high	UINT16	Actual frequency	0 - Max. freq.		
+8	low					
+9	high	UINT16	Maximum frequency	0 - 12,000 ↓	Maximum Frequency	5
+10	low					
+11	high	UINT32	Batch preselection	1 - 99999	Charging	6
+12	↓					
+13	low					
+14						
+15	high	UINT32	Remaining strokes	1 - 99999	Remaining Strokes	7
+16	↓					
+17	low					
+18						
+19	-	BYTE	Stroke length	0 - 100 ↓	Stroke Length	9
+20	high	UINT16	Errors	See ↗ 'All data objects' Table on page 10	Error Warning	12
+21	low					

Offset	Significance	Type	Name	Range	Modulname	Module no.
+22	high	UINT16	Warnings	See  'All data objects' Table on page 10		
+23	low					
+24	high	UINT32	Stroke counter	0 - (2 ³²)-1	Stroke Number	13
+25	↓					
+26	low					
+27						

5.5 Acyclical data traffic

(from DP-V1)

The acyclically transferred data is addressed via slot and index. All data summarised under one slot can then be addressed individually using the index, and acyclically transferred.



*Slots are identical to the **modules** for cyclical transfer.*

Slots of the acyclical data objects

No.	Slot	Index	Data object	Type	Length	Channel	Channel	Read/Write
0	Slot 0	1	Device identification	UINT32	4 bytes	MS1	MS2	Read
1	Slot 1	1	Status	UINT32	4 bytes	MS1	MS2	Read
2	Slot 2	1	Start/Stop	BYTE	1 byte	MS1	MS2	Write
3		2	Reset	BYTE	1 byte	MS1	MS2	Write
4	Slot 3	1	Mode	BYTE	1 byte	MS1	MS2	Write
5		2	Mode	BYTE	1 byte	MS1	MS2	Read
6	Slot 4	1	Frequency	UINT16	2 bytes	MS1	MS2	Write
7		2	Frequency	UINT16	2 bytes	MS1	MS2	Read
8		3	Actual frequency	UINT16	2 bytes	MS1	MS2	Read
9	Slot 5	1	Maximum frequency	WORD	2 bytes	MS1	MS2	Read
10	Slot 6	1	Batch preselection	UINT32	4 bytes	MS1	MS2	Write
11		2	Batch preselection	UINT32	4 bytes	MS1	MS2	Read
12		3	Batch start	BYTE	1 byte	MS1	MS2	Write
13		4	Batch memory	BYTE	1 byte	MS1	MS2	Write
14	Slot 7	1	Remaining strokes	UINT32	4 bytes	MS1	MS2	Read
15	Slot 8	1	External factor	UINT16	2 bytes	MS1	MS2	Write
16		2	External factor	UINT16	2 bytes	MS1	MS2	Read
17		4	External factor	BYTE	1 byte	MS1	MS2	Write
18	Slot 9	1	Stroke length	BYTE	1 byte	MS1	MS2	Read

No.	Slot	Index	Data object	Type	Length	Channel	Channel	Read/Write
19	Slot 10	1	Metering monitor	BYTE	1 byte	MS1	MS2	Write
20	Slot 11	1	Concentration	FLOAT	4 bytes	MS1	MS2	Read
21	Slot 12	1	Errors	UINT16	2 bytes	MS1	MS2	Read
22		2	Warnings	UINT16	2 bytes	MS1	MS2	Read
23	Slot 13	1	Stroke counter	UINT32	4 bytes	MS1	MS2	Read
24		3	Reset stroke counter	BYTE	1 byte	MS1	MS2	Write
25	Slot 14	1	Quantity counter	FLOAT	4 bytes	MS1	MS2	Read
26		2	Litres per stroke	FLOAT	4 bytes	MS1	MS2	Read
27		3	Reset quantity counter	BYTE	1 byte	MS1	MS2	Write
28	Slot 15	1	ID code	STRING	32 bytes	MS1	MS2	Read
29		2	Serial number	STRING	16 bytes	MS1	MS2	Read
30		3	Device name	STRING	32 bytes	MS1	MS2	Read/Write
31		4	Installation site	STRING	16 bytes	MS1	MS2	Read/Write

5.6 Extended diagnostic

(from the 7th byte)

The pump uses the mechanism of the PROFIBUS® extended diagnostic to communicate error statuses to the mast. The diagnostic telegram contains the extended diagnostic. The extended diagnostic contains the device-specific "Alarm_Type (48)" as well as the "Diagnostic_User_Data".

Structure of the extended PROFIBUS® diagnostic telegram

Header_Byte	Alarm_Type	Slot_Number	Alarm_Specifier	Diagnostic_User_Data
Bit 1-6: Length of the status message incl. Header_Byte	48	1	1	See Tab. 12
Bit 7-8: 0				

Diagnostic_User_Data consists of at least one group of 3 bytes with error information. Diagnostic_User_Data can consist of a maximum of 19 groups. The error information in a group is coded as follows:

Service no. (1st byte) (2nd byte)	Error type Type of data access (3rd byte)
No. - see Tab. 2	
0x30	OK
0x31	Date outside of limits
0x32	Date protected
0x34	Option not installed

Service no. (1st byte) (2nd byte)	Error type Type of data access (3rd byte)
0x35	Service not defined
0x36	Value cannot be changed
0x37	Update complete
0x55	Communications error
0xD3	Write access
0xE5	Read access