



Operating Instructions

DULCOMETER® D1C

Part 2: Adjustment and Operation,
Measured Variable Redox/ORP

D1C2-001-D



Type D

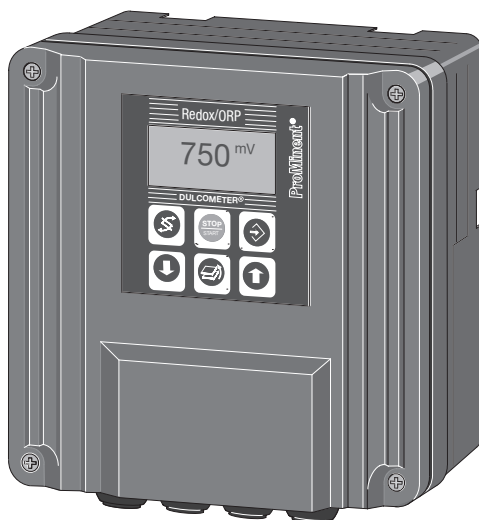

Type W

D1C A _____

Please enter the identity code of your device here.

**Please completely read through operating instructions! · Do not discard!
The operator shall be liable for any damage caused
by installation or operating errors!**

2 General User Information

	Page
1 Device Identification / Identity Code	2
2 General User Information	3
3 Device Overview / Controls	4
4 Functional Description	5
5 Display Symbols	6
6 Operation	7
7 Restricted Operating Menu	8
Layout	8
Description	9
8 Complete Operating Menu	12
Overview	12
Description	13
9 Fault / Remarks / Troubleshooting	24

General User Information

These operating instructions describe the technical data and function of the series DULCOMETER® D1C controller, provide detailed safety information and are divided into clear steps.



IMPORTANT

- *Please observe the parts of these operating instructions applicable to your particular version! This is indicated in the Section “Device Identification / Identity Code”.*
- *Correct measuring and dosing is only possible in the case of impeccable operation of the probe. The probe has to be calibrated / checked regularly!*

NOTE

A form “Documentation of controller settings type D1C” is available under www.prominent.com/documentation_D1C for the purpose of documenting the controller settings.

3 Device Overview / Controls

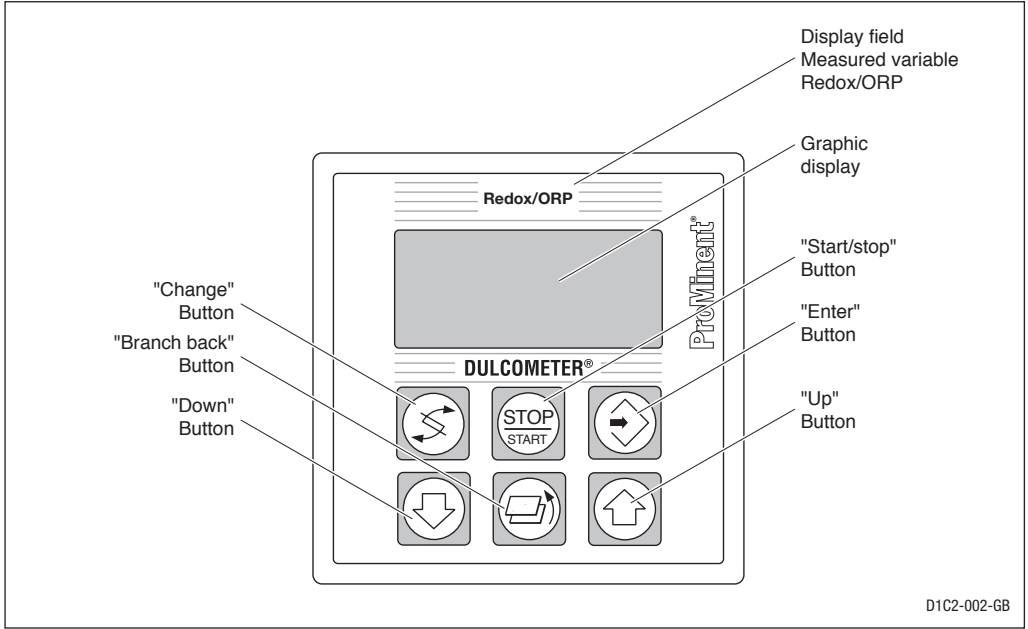

	<p>CHANGE button</p> <p>To change over within a menu level and to change from one variable to another within a menu point.</p>
	<p>START/STOP button</p> <p>Start/stop of control and metering function.</p>
	<p>ENTER button</p> <p>To accept, confirm or save a displayed value or status. For alarm acknowledgement.</p>

	<p>UP button</p> <p>To increase a displayed numerical value and to change variables (flashing display)</p>
	<p>BRANCH BACK button</p> <p>Back to permanent display or to start of relevant setting menu.</p>
	<p>DOWN button</p> <p>To decrease a displayed numerical value and to change variables (flashing display).</p>

4 Functional Description

NOTE

Please refer to the description of the complete operating menu in Section 8 for a detailed description of the individual characteristics of the DULCOMETER® D1C controller!

4.1 Operating Menu

The D1C controller permits settings to be made in two different menus. All values are preset and can be changed in the **complete operating menu**.

The controller is delivered with a **restricted operating menu** so that the D1C controller can be used effectively in many applications from the very onset. If adaptations prove to be necessary, all relevant parameters can then be accessed by switching over to the complete operating menu (see "General Settings").

4.2 Access Code

Access to the setting menu can be prevented by setting up an access code. The D1C controller is supplied with the access code 5000 which permits free access to the setting menu. The calibration menu remains freely accessible even if access to the setting menu is blocked by the code.

4.3 Control

The D1C can operate as a proportional controller or as a PID controller - depending on the device version (see identity code) and the setting.

The controlled variable is recalculated once a second. Control procedures which require rapid correction of setpoint deviations (less than approx. 30 seconds) cannot be processed with this controller. The cycle times must be taken into consideration when activating solenoid valves (pulse length) in the same way as their running times when activating servomotors (3-point).

Via the control input pause, the control function (selection of controlled variable) can be switched off. The calculation of the controlled variable starts again after cessation of "pause".

4.4 Feed Forward Control

The D1C controller can process a signal of a feed forward control. Depending on the device version (see identity code) and the setting, this signal can be obtained in any form of a 0–20 mA or 4–20 mA signal or as a digital contact signal with the maximum frequencies 10 Hz or 500 Hz.

This signal can be used, for example, for flow-proportional metering (multiplicative effect) or feed forward-dependent basic load metering (additive effect). The result of control variable calculation from the proportional or PID control is multiplied by or added to the feed forward signal. A multiplicative feed forward variable at the level of the set rated value carries over the calculated controlled variable unchanged into the control variable:

$$\text{Control variable} = \text{Feed forward variable/rated value} \times \text{calculated controlled variable}$$

During start-up, the zero point has to be checked. The feed forward control is not designed for switching off permanently the actuating variable (signal ≈ 0).

An additive feed forward variable at the level of the rated value results in maximum control variable:

$$\text{Control variable (max. 100 \%)} = (\text{Feed forward variable/rated value} \times \text{max. control variable}) + \text{calculated controlled variable}$$

4.5 Error Messages

Error messages and information are indicated on the bottom line in the permanent display 1. Errors to be acknowledged (acknowledgement switches off the alarm relay) are indicated by the "E". Errors/notes which still apply after acknowledgement are indicated alternately. During correction variable processing (temperature for correction of pH-value), the value is indicated in the same line as the error/note. Faults which are rectified of their own accord due to changed operating situations are removed from the permanent display without the need for acknowledgement.

5 Display Symbols

The display of the DULCOMETER® D1C controller uses the following symbols:

Description	Comment	Symbol
Limit value transgression Relay 1, upper	Symbol left	↑
Relay 1, lower	Symbol left	↓
Relay 2, upper	Symbol right	↑
Relay 2, lower	Symbol right	↓
Metering pump 1 (oxidant) Control off	Symbol left	■
Control on	Symbol left	□
Metering pump 2 (reducing agent) Control off	Symbol right	■
Control on	Symbol right	□
Solenoid valve 1 (oxidant) Control off	Symbol left	▲
Control on	Symbol left	△
Solenoid valve 2 (reducing agent) Control off	Symbol right	▲
Control on	Symbol right	△
Servomotor Control, open relay		▲ △
Control, close relay		△ ▲
Without control		▲ ▲
Position feedback	Thickness of bar increases from left to right during opening	▬
Stop button pressed		O
Manual metering		M
Fault		ε

6 Operation

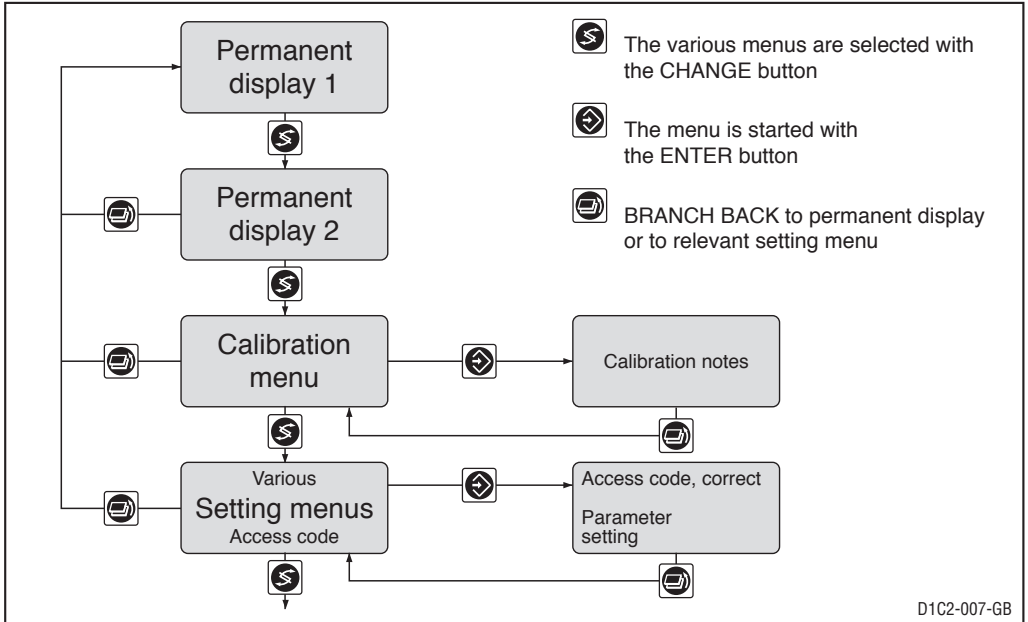

NOTE

Access to the setting menus can be barred with the access code!

The number and scope of setting menus is dependent on the device version!

If the access code is selected correctly in a setting menu, then the following setting menus are also accessible!

If within a period of 10 minutes no button is pushed, the unit automatically branches back from the calibrating menu or a setting menu to the permanent display 1.

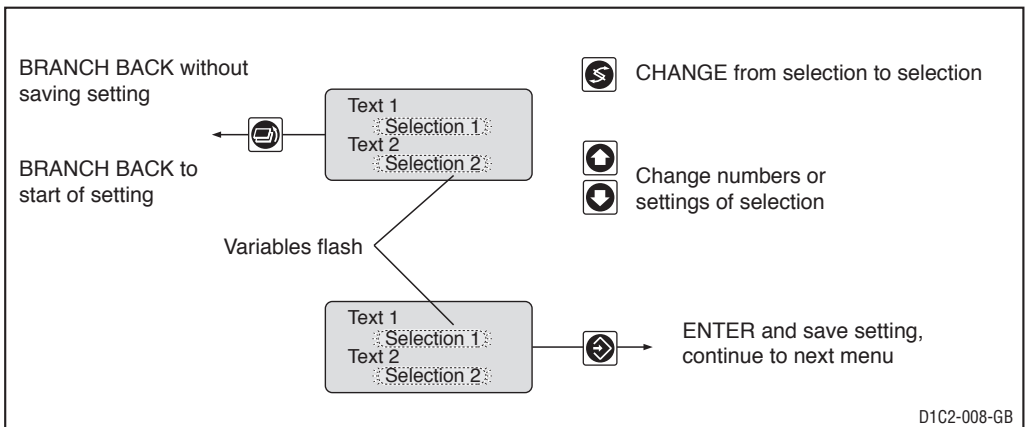

7 Restricted Operating Menu / Layout

The restricted operating menu permits simple operation of the most important parameters. The following overview shows the settings which can be selected.

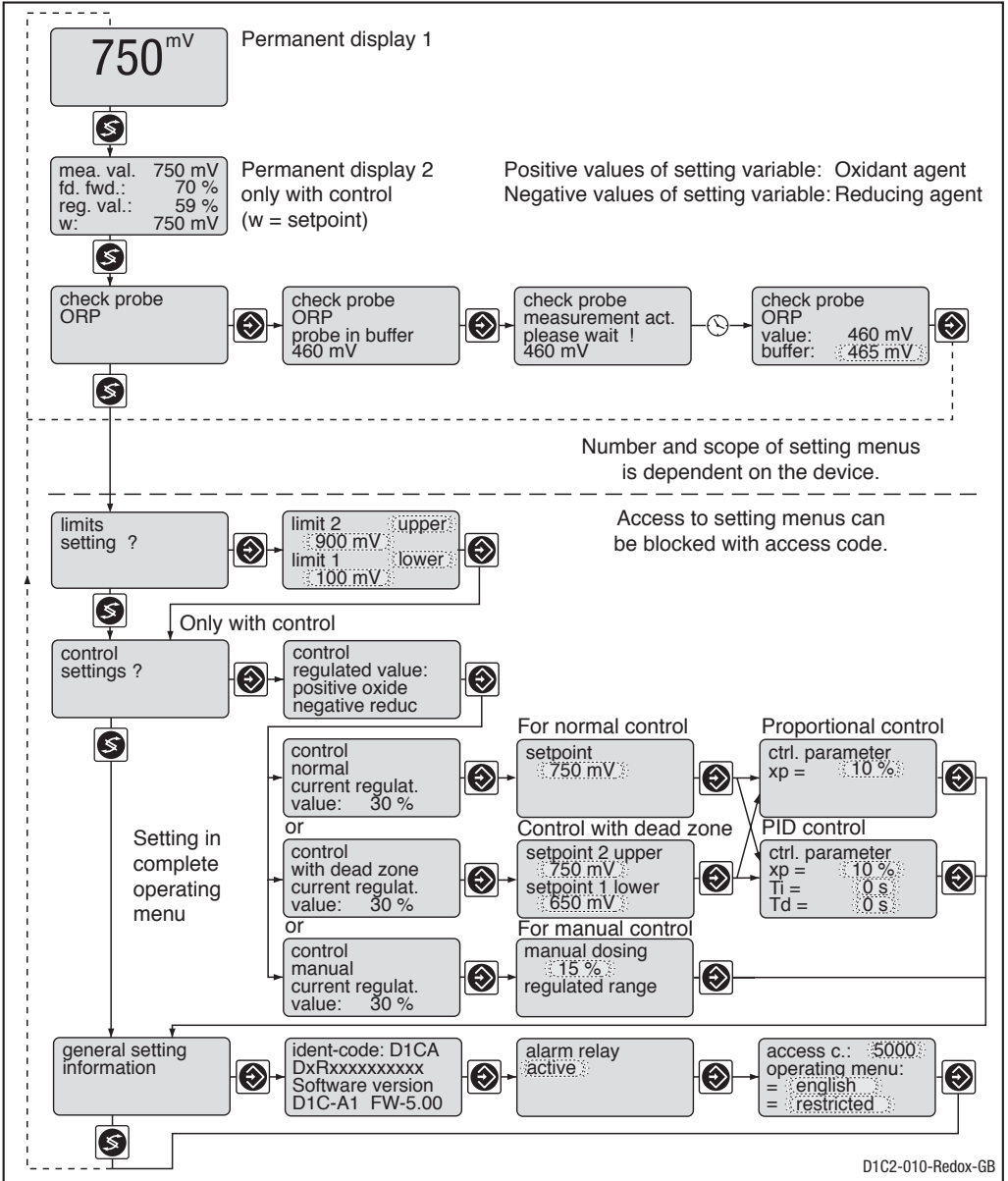

Restricted Operating Menu / Description

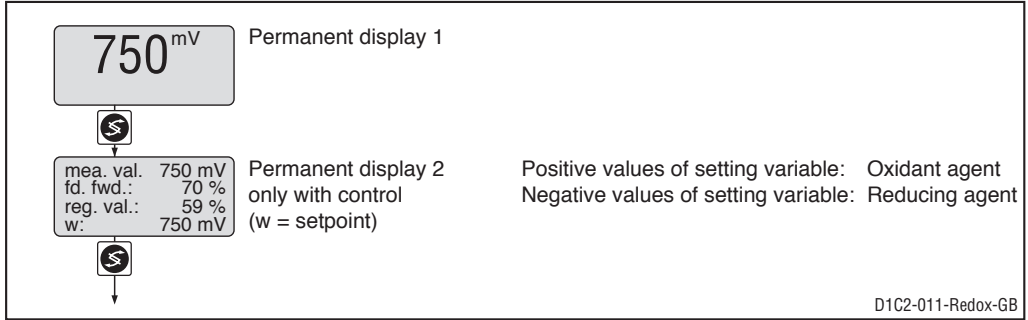

Checking the Redox Probe

During calibration, the D1C sets the command outputs to "0". Exception: if a basic load or a manual control variable was set, these are maintained during calibration. The standard signal outputs mA (measuring value or correction value) are frozen. The measured value or the standard buffer value 220 mV or 465 mV is proposed as the buffer value; this value is adjustable (arrow keys). After everything has been checked, all error tests which refer to the measured value are restarted.

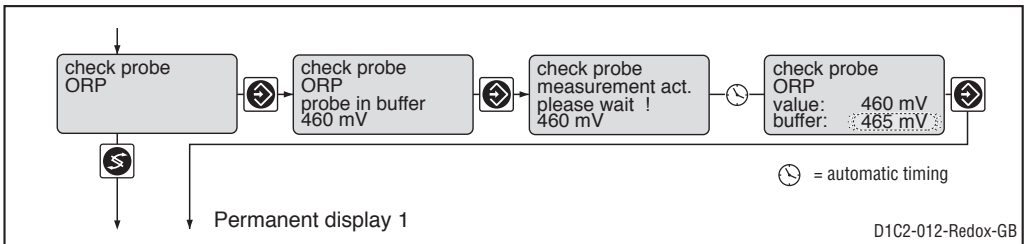

	Initial value	Possible values			Remarks
		Increment	Lower value	Upper value	
Buffer values 185–265 mV 425–505 mV	Measured value 220 mV 465 mV	1 mV	-2000 mV	+2000 mV	

Error message	Condition	Effect
Measured value high	Measured value 40 mV > buffer	Return to permanent display: Basic metering load
Measured value low	Measured value 40 mV < buffer	"

Restricted Operating Menu / Description

Limits

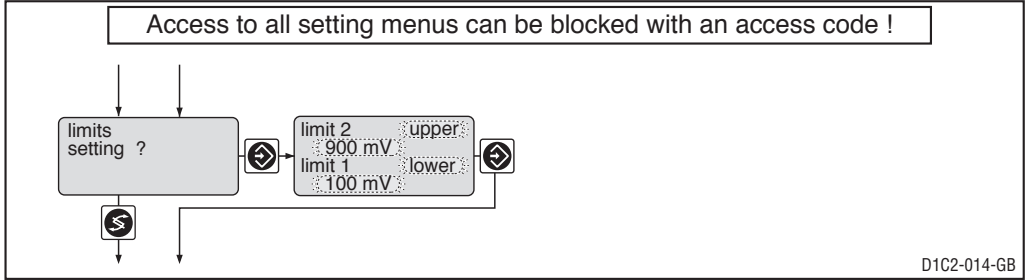

	Initial value	Possible values			Remarks
		Increment	Lower value	Upper value	
Type of limit transgression	Limit 1: lower Limit 2: upper	upper lower off*			Limit transgression when exceeding or dropping below value *only with limit relay
Limit value	Limit 1: 500 mV Limit 2: 1000 mV	1 mV 1 mV	-2000 mV -2000 mV	2000 mV 2000 mV	

Control

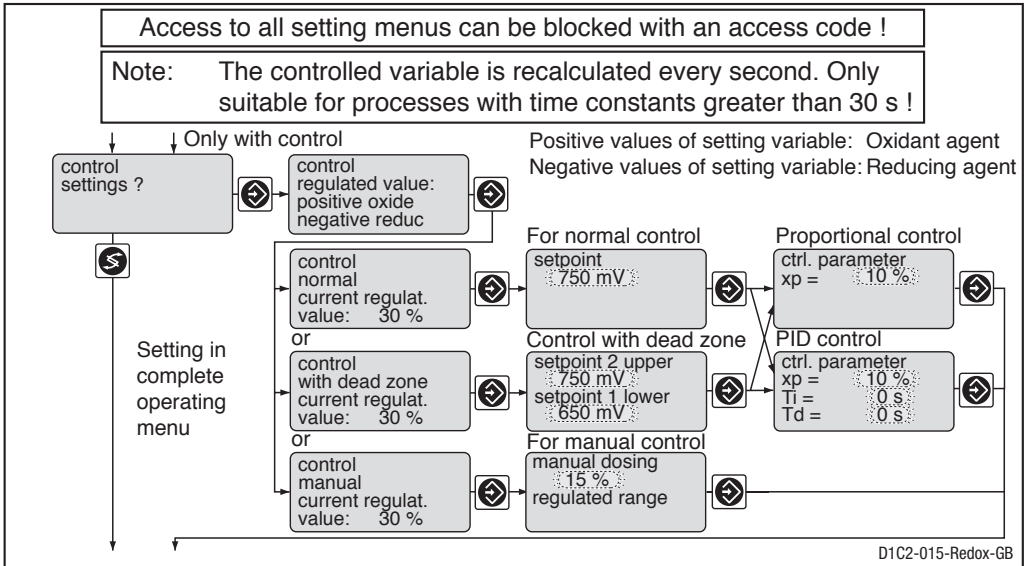

Restricted Operating Menu / Description

	Initial value	Possible values			Remarks
		Increment	Lower value	Upper value	
Setpoint	750 mV	1 mV	lower limit measuring range	upper limit measuring range	2 setpoints necessary for control with dead zone. Setpoint 2 > setpoint 1
Control parameter xp	10 %	1 %	1 %	500 %	xp referred to measuring range
Control parameter Ti	off	1 s	1 s	9999 s	Function off = 0 s
Control parameter Td	off	1 s	1 s	2500 s	Function off = 0 s
Manual metering	0 %	1 %	-100 %	+100 %	

Abbreviations for control variables:

x_p = 100 %/Kp (inverse proportional coefficient)

T_i = I controller integration time [s]

T_d = D controller differential time [s]

General Settings

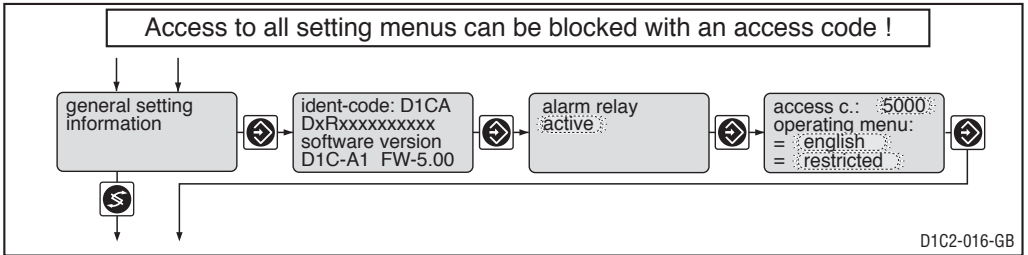

	Initial value	Possible values			Remarks
		Increment	Lower value	Upper value	
Alarm relay	active	active not active			
Access code	5000	1	1	9999	
Language	as per identity code	as per identity code			
Operating menu	restricted	restricted complete			

Access Code

Access to the setting menu can be prevented by setting up an access code. The DULCOMETER® D1C controller is supplied with the access code 5000 which permits free access to the setting menu. The calibration menu remains freely accessible even if access to the setting menu is blocked by the code.

8 Complete Operating Menu / Overview

All parameters of the controller can be set in the complete operating menu (access see previous page). The following overview shows the settings which can be selected:

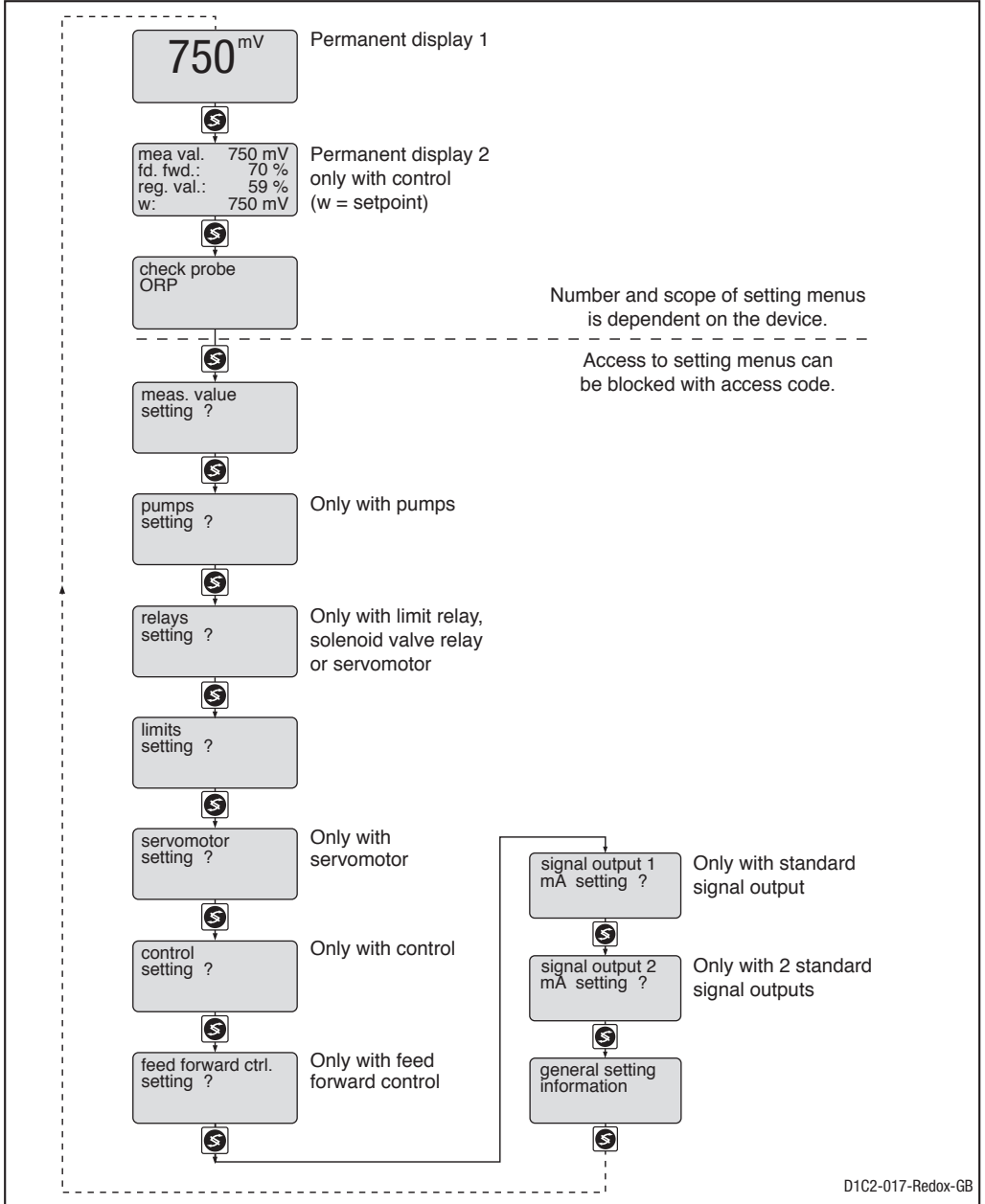

Complete Operating Menu / Description

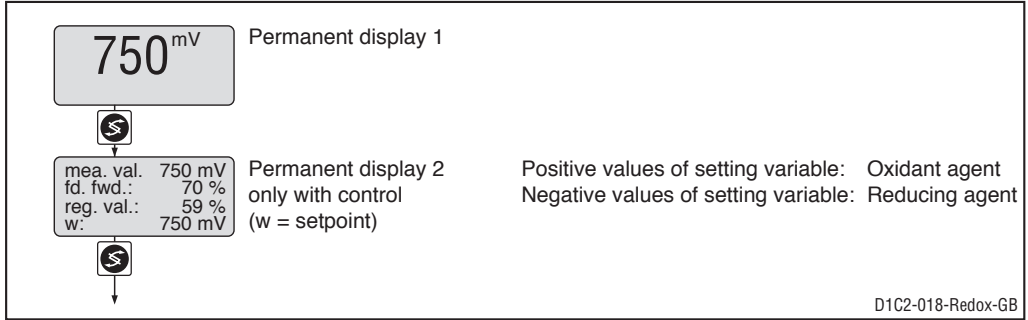

Checking the Redox Probe

During calibration, the D1C sets the command outputs to "0". Exception: if a basic load or a manual control variable was set, these are maintained during calibration. The standard signal outputs mA (measuring value or correction value) are frozen. The measured value or the standard buffer value 220 mV or 465 mV is proposed as the buffer value; this value is adjustable (arrow keys). After everything has been checked, all error tests which refer to the measured value are restarted.

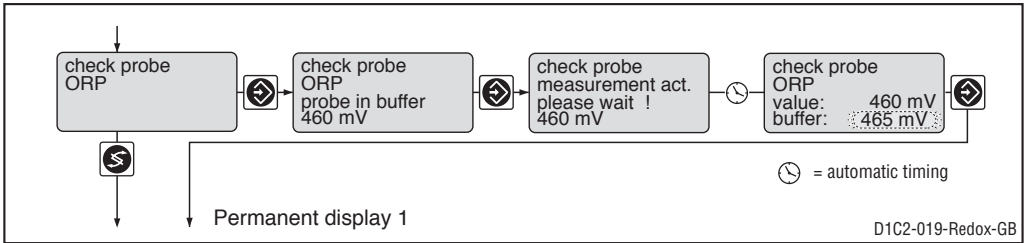

	Initial value	Possible values			Identification code expression
		Increment	Lower value	Upper value	
Buffer values 185–265 mV	Measured value 220 mV	1 mV	-2000 mV	+2000 mV	if measured variables 2 and 5 are connected
425–505 mV	465 mV		–	+1000 mV	if measured variable 1 is connected

Error message	Condition	Effect
Measured value high	Measured value 40 mV > buffer	Return to permanent display: Basic metering load
Measured value low	Measured value 40 mV < buffer	Return to permanent display: Basic metering load

Complete Operating Menu / Description

Measured Value

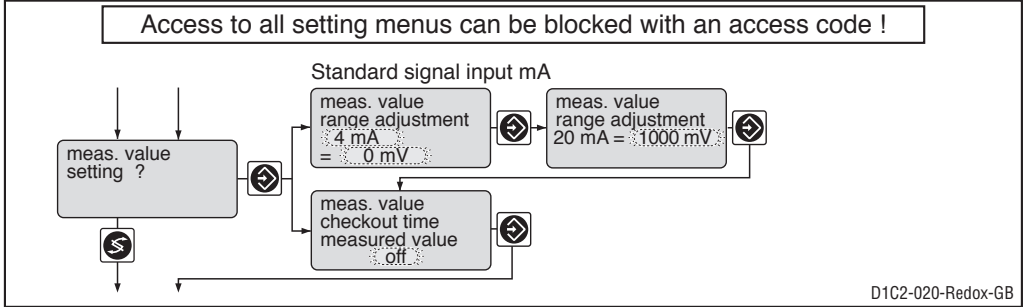

IMPORTANT

When changing the range adjustment, the adjustments in all menus have to be checked!

	Initial value	Possible values			Remarks
		Increment	Lower value	Upper value	
Standard signal input lower signal limit	4 mA	0 mA 4 mA			
Allocated probe voltage	0-1 V	1 mV	-2000 mV	+2000 mV	
Checkout time	off	1 s	1 s	9999 s	Constant measurement signal results in message and alarm. Function off = 0 s

Control Time Measuring Value



IMPORTANT

This function may not be activated for applications where it can be assumed that the measuring value does not change.

This function checks whether the measuring value from the sensor (measuring value input) changes within the “control time measuring value”. It is assumed that the value does not change for an intact sensor.

If the measuring value does not change during this control time, the DULCOMETER® D1C sets the control output to “0” and the alarm relay drops out. The LCD display shows e.g. the message “check mV-probe”.

Complete Operating Menu / Description

Correction Value*

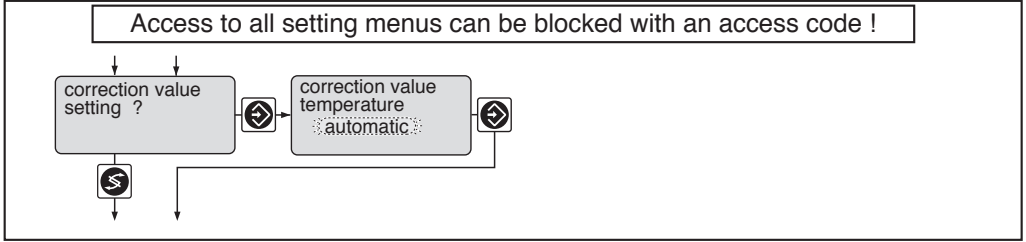

*In the setting menu “correction value” for this equipment enables you to display the temperature or to maintain an mA signal proportional to the temperature. No temperature adjustment is made to the measured variable!

Pumps

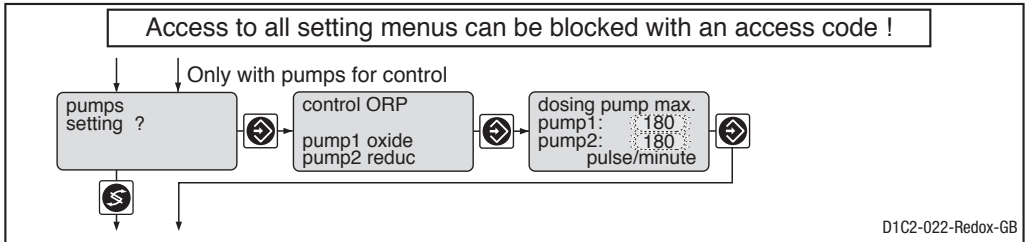

D1C2-022-Redox-GB

	Initial value	Possible values			Remarks
		Increment	Lower value	Upper value	
Max. stroke/minute of pumps 1 and 2	180	1	1	500	off = 0 strokes/min

Relay for power control

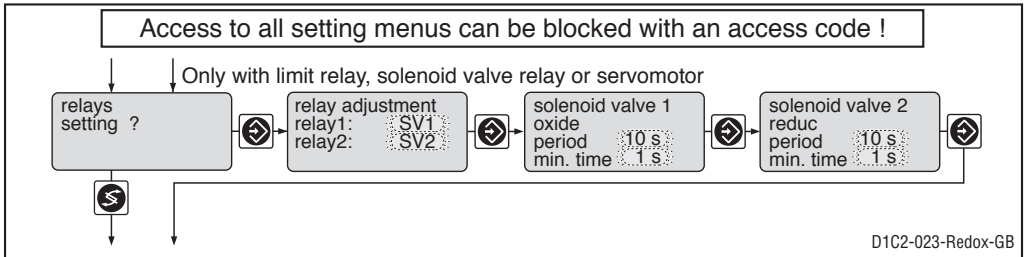

D1C2-023-Redox-GB

Complete Operating Menu / Description

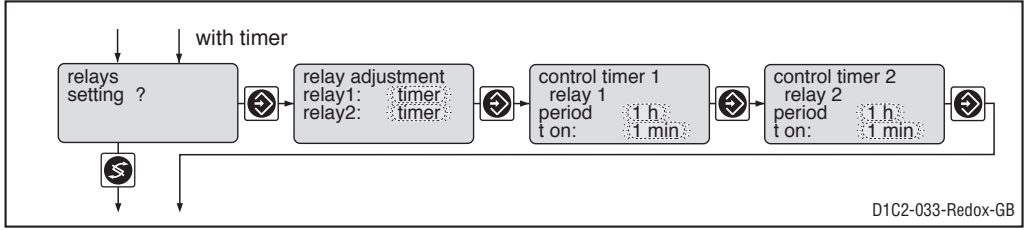

D1C2-033-Redox-GB

	Initial value	Possible values			Remarks
		Increment	Lower value	Upper value	
Relay adjustment	as per identity code				
Relay 1		Solenoid valve 1 Limit value 1* Actuator 1 Timer 1 Servomotor off			*For "limit value", the relays remain active, even in the event of a fault. only with servomotor
Relay 2		Solenoid valve 2 Limit value 2* Actuator 2 Timer 2 off			
Cycle	10 s	1 s	10 s	9999 s	for solenoid valve for solenoid valve Set here the smallest permitted operating factor of the connected device.
min. time	1 s	1 s	1 s	Cycle/2	
Period (Cycle)	off	1 h	1 h / off	240 h	for timer for timer
t on	1 min	1 min	1 min	60 min	

NOTE

The limit value relay can be defined in such a way as to respond as an actuator, i.e. if a limit value relay closes a circuit, it opens when a pause contact is activated and/or for a subsequent delay period t_d (if t_d is set to > 0 min in "General settings").

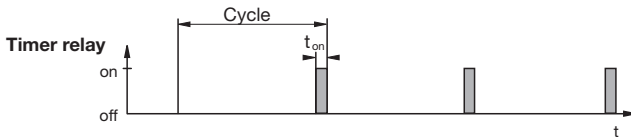

IMPORTANT

The timer will be reset if there is a drop in the power supply.

Complete Operating Menu / Description

At the end of the (timer) cycle time, the DULCOMETER® D1C closes the assigned relay for the duration of “t on” (timer). “Pause” interrupts the timer.

When the clock is shown in the LC display, the timer can be reset to the start of the cycle at precisely this point using the Enter button.

The % figure in the LC display indicates the progress of the current cycle.

Timer relays may be used, e.g. for shock metering or sensor cleaning.

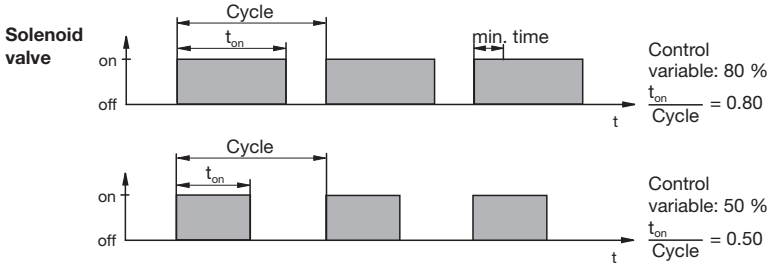

The switching time of the DULCOMETER® D1C (solenoid valve) depends on the actuating variable and the “min. time” (smallest permitted operating factor of the connected device).

The actuating variable determines the ratio $t_{on}/cycle$ and thus the switching times (see fig. above).

The “min. time” influences the switching times in two situations:

a) theoretical switching time < min. time:

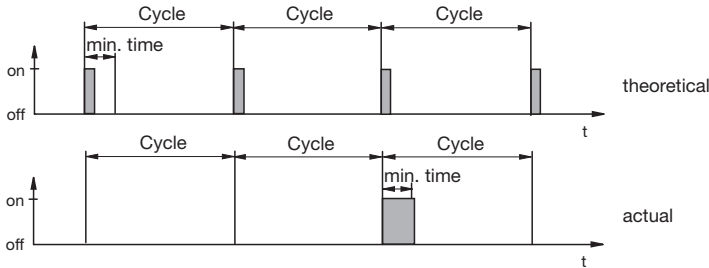

The DULCOMETER® D1C does not switch for a certain number of cycles until the sum of the theoretical switching times exceeds the “min. time”. Then the DULCOMETER® D1C switches for the duration of this total time.

b) theoretical switching time > (cycle - min. time) and calculated switching time < cycle

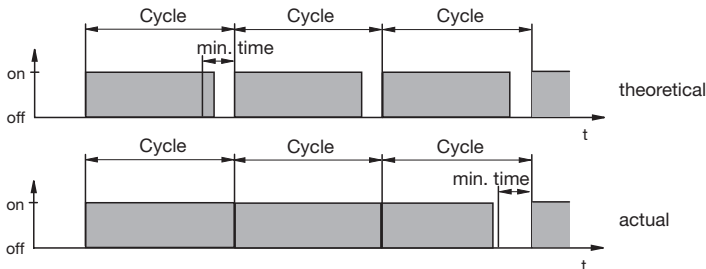

The DULCOMETER® D1C does not deactivate for a certain number of cycles until the differences between cycle and theoretical switching time exceed the “min. time”.

Complete Operating Menu / Description

Limits

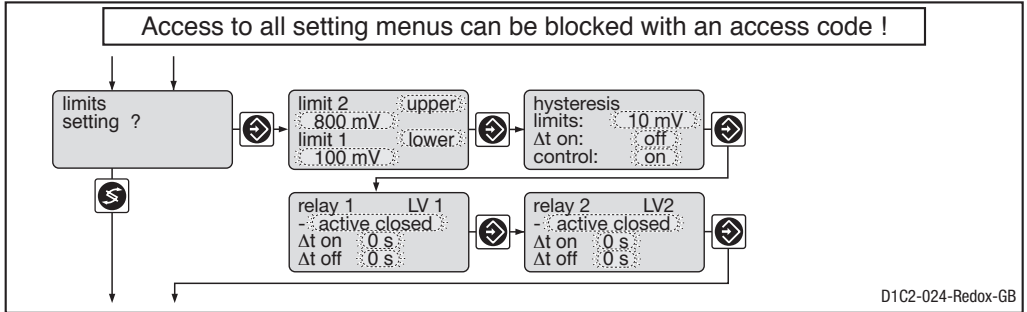

	Initial value	Possible values			Remarks
		Increment	Lower value	Upper value	
Type of limit transgression		upper			Limit transgression when exceeding or dropping below value *only with limit relay
Limit 1:	lower	lower			
Limit 2:	upper	upper*			
Limit value					
Limit 1:	500 mV	1 mV	-2000 mV	2000 mV	
Limit 2:	1000 mV	1 mV	-2000 mV	2000 mV	
Hysteresis limits	10 mV	1 mV	10 mV	2000 mV	Effective in direction of cancelling limit transgression
Checkout time limits	off	1 s	1 s	9999 s	Results in message and alarm. off = 0 s: Function switched off, no message, no alarm
Control	on	on off			
Actuating direction	active closed	active closed active open			Reacts as make contact Reacts as break contact
limit value 1; limit value 2					
Switch-on delay Δt on	0 s	1 s	0 s	9999 s	
Switch-off delay Δt off	0 s	1 s	0 s	9999 s	

If the limit is exceeded for longer than the “Delay time - limit values”, an error message is given which must be acknowledged, and the alarm relay is broken. If “Control” is also set to “off” the control process stops.

Complete Operating Menu / Description

Servomotor

The **operating range** is defined by the total resistance range of the feedback potentiometer. The maximum limit of the range actually used is set by defining the **control range**.



IMPORTANT

- To ensure correct operation, the activation time of the actuator used should not be less than 25 seconds for the control range from 0...100 %!
- Activation of the servomotor must be carried out with the same meticulous care as taken when calibrating a measuring probe.

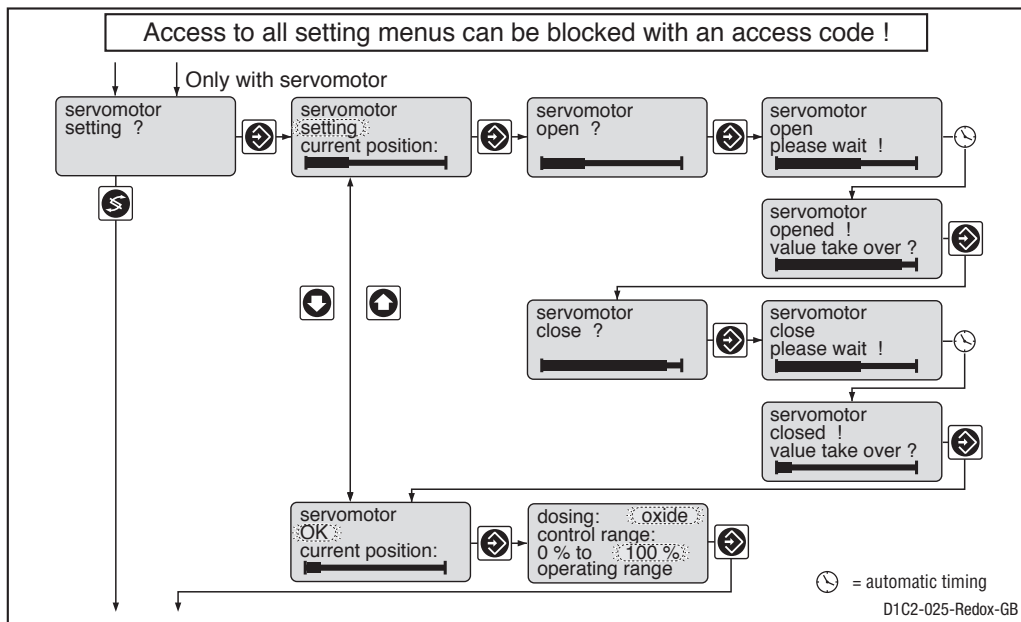

	Initial value	Possible value			Remarks
		Increment	Lower value	Upper value	
Servomotor	Setting	Setting ok off			
Control direction	Oxidant	Oxidant Reducing			
Control range	100 %	1 %	10 %	100 %	in % of operating range

NOTE

- If the broad bar is to the far right, the servomotor is fully open.
- The continuous display shows the degree (in %) to which it is open (the greater the percentage, the more open the servomotor).

Complete Operating Menu / Description

Control

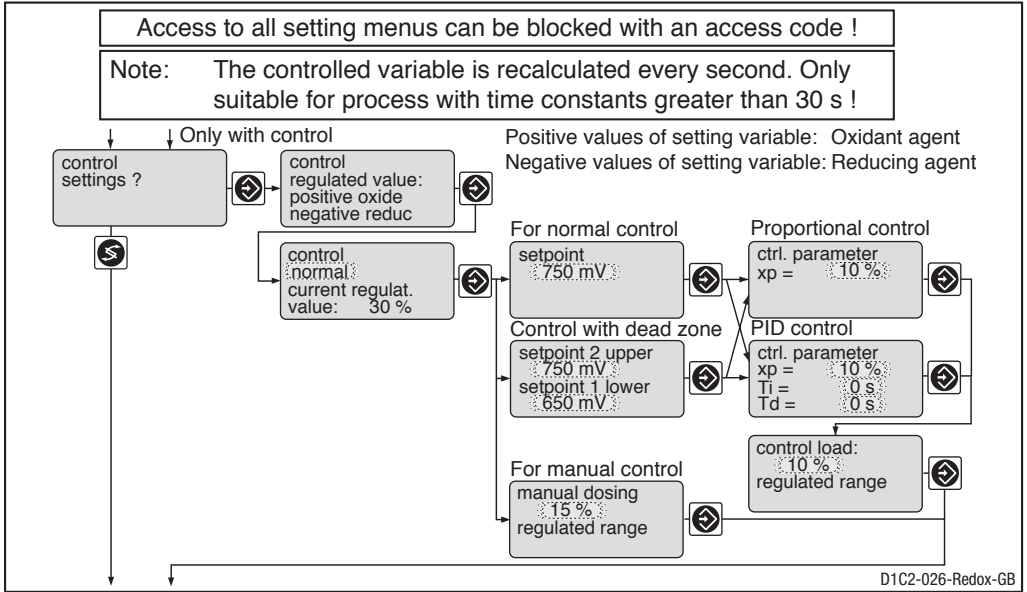

	Initial value	Possible values			Remarks
		Increment	Lower value	Upper value	
Control	normal	normal with dead zone manual			When controlling with dead zone, the feed forward control is not used for measured values within the dead zone. 2 setpoints necessary for control with dead zone. Setpoint 2 > setpoint 1 xp referred to measuring range
Setpoint	750 mV	1 mV	Lower limit measuring range	Upper limit measuring range	
Control parameter xp	10 %	1 %	1 %	500 %	
Control parameter Ti	off	1 s	1 s	9999 s	Function off= 0 s
Control parameter Td	off	1 s	1 s	2500 s	Function off = 0 s
Additive basic load	0 %	1 %	-100 %	+100 %	
Manual metering	0 %	1 %	-100 %	+100 %	

Abbreviations for control variables:

x_p : 100 %/K_p (inverse proportional coefficient)

T_i : Integration time of I-controller [s]

T_d : Differential time of D-controller [s]

Complete Operating Menu / Description

Feed Forward Control

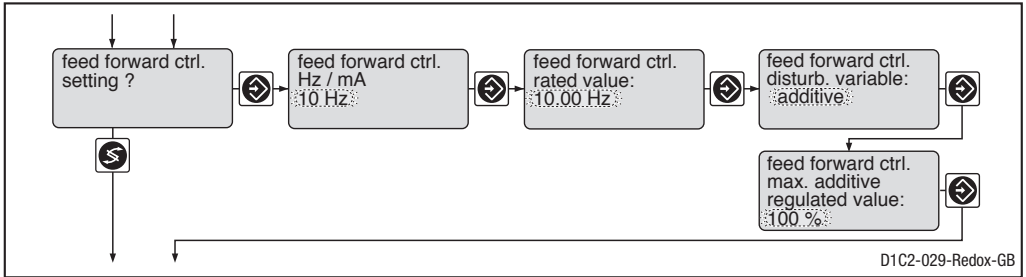

	Initial value	Possible values			Remarks
		Increment	Lower value	Upper value	
Feed forward control (Flow)	as per identity code	None 10 Hz 500 Hz			Signal processing: Signal <0.02 Hz = no flow Signal <0.2 Hz = no flow Signal <0.2 mA = no flow Signal <4.2 mA = no flow
	Standard signal: 4–20 mA	0...20 mA 4...20 mA			
Feed forward control rated value	10 Hz 500 Hz 20 mA	0.01 Hz 1 Hz 0.1 mA	0.1 Hz 5 Hz 0/4 mA	10 Hz 500 Hz 20 mA	Depending on signal type. Maximum limitation of range used.
Feed forward control	multiplicative	multiplicative			
Feed forward control effect		additive			
Max. add. regulated variable	100 %	1 %	-500 %	+500 %	only with add. feed forward control

Standard Signal Output 1

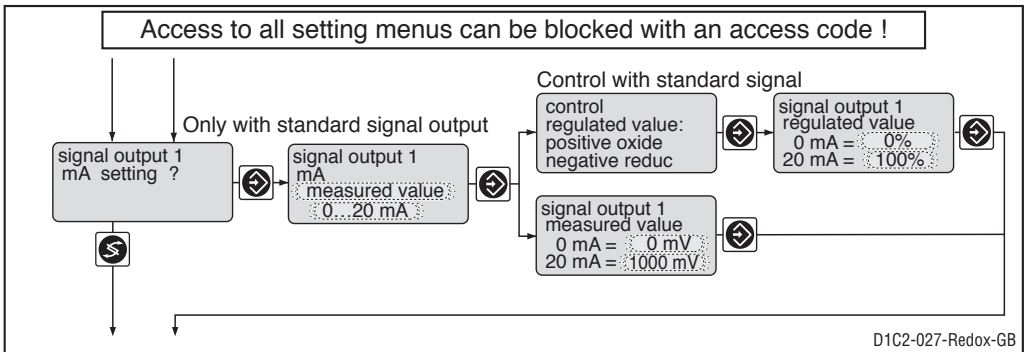

Complete Operating Menu / Description

Standard Signal Output 2

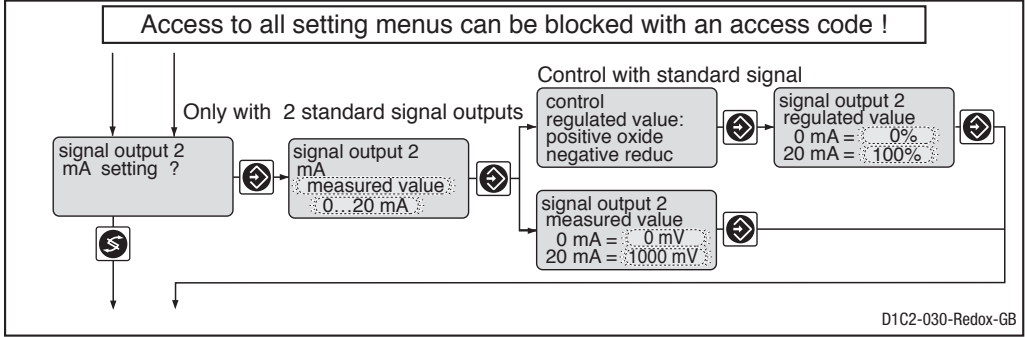

	Initial value	Possible values			Remarks
		Increment	Lower value	Upper value	
Variable allocation	as per identity code	Measured value Controlled variable			If control applicable
Output range	0...20 mA	0...20 mA 4...20 mA 3.6/4-20 mA			Reduction to 3.6 mA when alarm relay switches (not limit value violation)
Range measured value	0-1 V	1 mV	-2000 mV	2000 mV	Minimum range 10 mV
Range controlled variable	0 %...+100 %	1 %	-100 %	+100 %	Minimum range 1 % of measured value

General Setting

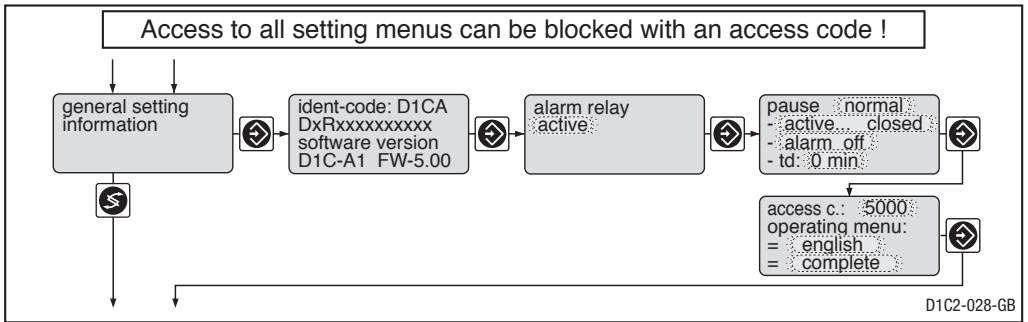

Complete Operating Menu / Description

	Initial value	Possible values		Upper value	Remarks
		Increment	Lower value		
Alarm relay	active	active not active			Reacts as make contact Reacts as break contact Alarm relay can be triggered by pause contact
Pause	normal	normal Hold			
Control input pause	active closed	active closed active open			
Pause with alarm	off	off on			
td	0 min	1 min	0 min	60 min	
Access code	5000	1	1	9999	
Language	as per identity code	as per identity code			
Operating menu	complete	restricted complete			

Standard Pause

If the pause switch is off, the DULCOMETER® D1C sets the operating outputs to “0” for as long as the pause switch is off or for a set time-delay t_d (if t_d is set to > 0 min). Whilst the pause switch is off, the D1C establishes the P-proportion in the background.

With PID control (Identity code characteristics “control characteristic” = 2): the I-proportion is stored when the pause is switched off (I-proportion then usually only present if $T_i > 0$ has been selected in the “Control setting?” setting menu).

Exception: the standard signal outputs mA for the measured value or correction value are not affected by the pause.

After pause is activated, the operating outputs remain at “0” for the length of the time delay t_d . The time delay t_d must be set up in such a way that in this time e.g. sample water (process-specific current concentration) flows to the sensor.

With PID control (Identity code characteristics “control characteristic” = 2): The control variable output resulting from the pause and the expiry of the time-delay t_d is reconciled jointly with the current P-component and (if T_i is set > 0) with the stored I-component.

Pause Hold

If the pause switch is off, the DULCOMETER® D1C freezes the operating output at the most recent value for as long as the pause switch is off or for a set time-delay t_d (if t_d is set to > 0 min). Whilst the pause switch is off, the D1C establishes the P-proportion in the background.

With PID control (Identity code characteristics “control characteristic” = 2):

Even the mA standard signal outputs for measured value or correction value are frozen.

After pause is activated, the operating outputs remain frozen for the length of the time delay t_d . The time delay t_d must be set up in such a way that in this time e.g. sample water (process-specific current concentration) flows to the sensor.

With PID control (Identity code characteristics “control characteristic” = 2): The control variable output resulting from the pause and the expiry of the time-delay t_d is reconciled jointly with the current P-proportion and (if T_i is set > 0) with the newly established I-proportion.

Access Code

Access to the setting menu can be prevented by setting up an access code. The DULCOMETER® D1C controller is supplied with the access code 5000 which permits free access to the setting menu. The calibration menu remains freely accessible even if access to the setting menu is blocked by the code.

9 Fault / Remarks / Troubleshooting

Fault	Fault text	Symbol	Effect on metering	Effect on control	Alarm with acknowledgement	Remarks	Remedy
Measured value Checkout time exceeded	measured value <i>Check mV probe</i>	€	Basic load	Stop	Yes	Function defeatable	Check function of probe
				Stop	Yes		
Signal exceeded/drops below value	<i>mV input faulty</i>	€	Basic load	Stop	Yes	Signal $3.0 \pm 0.2 \text{ mA}$ or >math>23 \pm 0.2 \text{ mA}</math>	Check probe, transducer and cable connection
Check probe with error	<i>mV calibration faulty</i>	€	Basic load	Stop	No	Metering continues in case of error with measured values	Check probe, replace if necessary, recalibrate if necessary
Correction measured variable Signal exceeds/drops below value	<i>te-input</i> ↑↓	€			Yes	Pt100 Signal > 138,5 Ω Signal $3.0 \pm 0.2 \text{ mA}$ or >math>23 \pm 0.2 \text{ mA}</math> Value last validated is used	Check sensor, transducer and cable connection
Feed forward control Signal drops below value	multiplicative additive <i>feed fwd. <math>< 4 \text{ mA}</math></i>	€	stop continue	continue	Yes	Signal $3.8 \pm 0.2 \text{ mA}$ or >math>23 \pm 0.2 \text{ mA}</math> Value last validated is used	Check probe, transducer and cable connection
				continue	Yes		
Signal exceeded	<i>feed fwd. >math>23 \text{ mA}</math></i>	€	continue	continue	Yes	Function defeatable	Define cause, reset values if necessary
Limit transgression after checkout time	<i>mV-limit value 1</i>	€	Stop or basic load	Stop	Yes	Servomotor closes Electronic data defective	Check servomotor
Control "on" Control "off"	<i>mV-limit value 2</i>	€	Stop	Stop	Yes		
Servomotor Position not reached	<i>Servomotor defective</i>	€	Stop	Stop	Yes		
Electronics error	<i>System error</i>	€	Stop	Stop	Yes		Call in service
Operation	Note text	Symbol	Effect on metering	Effect on control	Alarm with acknowledgement	Remarks	Remedy
Pause contact	<i>Pause</i>	€	Stop	Stop	No/Yes*	No further fault check	-
				Stop	No		
Stop button	<i>Pause/Hold</i>	€	Stop	Pt-part frozen	No	Relay drops out	-
				Stop	No		
During checking sensor	Stop	€	Basic load	Stop	No	No error processing of measured variable	-
				Stop	No		
Measured 40 mV > buffer Measured 40 mV < buffer	<i>Measured value high</i>	€	Basic load	Stop	No		Check probe, replace if necessary
				Stop	No		
Probe signal too unsteady	<i>Measured value low</i>	€		Stop	No		
During servomotor setting Position feed back wrong Upper position <math>< 40 \text{ \%}</math> max. value Lower position >math>30 \text{ \%}</math> range	<i>Direction check</i> <i>Final value small</i> <i>Final value big</i>	€				Without correct adjustment the last valid values are still used	Check connection of relay, potentiometer. Adjust the operation region of the servomotor correctly

* Depends on whether "alarm off" or "alarm on" in "General Settings".